

ENGINEERING SUCCESS



11827 W 112th Street, Suite 200
Overland Park, KS 66210
913.317.9390

DRAINAGE REPORT FOR

ARCADE ALLEY
316 SE Douglas Street
Lee's Summit, Missouri 64063

PROJECT NUMBER: 2202010333
DATE: June 2022
REVISED: August 2022



Table of Contents

General Information	1
Purpose	1
Location	1
Development.....	1
Datum	1
Soils	1
Flood Insurance Rate Map (FIRM).....	1
Drainage Patterns	1
Hydrologic Methods	1
Table 1 - Rainfall Depths (inches) for 24- Hour Design Storm	1
Drainage Conditions	2
Existing Conditions	2
Table 2. Existing Drainage Conditions.....	2
Proposed Conditions.....	2
Table 3. Proposed Drainage Conditions.....	2
Storm Water Quality (BMP's)	2
Utilities	3
Water	3
Sanitary Sewer.....	3
Stormwater Sewer	3
Permitting	3
U.S. Army Corps of Engineers.....	3
Federal Emergency Management Agency (FEMA)	3
Missouri Department of Natural Resources (MoDNR).....	3
Missouri Department of Conservation (MDC)	3
Missouri Historical Society (MHS)	3
Summary	3
Appendix A - USGS Quadrangle	4
Appendix B - Aerial Photograph	5
Appendix C - Soils Survey	6
Appendix D - FEMA FIRM	7
Appendix E - Hydraflow Hydrograph Outputs	8
Appendix F - Existing Drainage Areas	9
Appendix G - Proposed Drainage Areas	10

General Information

Purpose

This report evaluates the management of drainage and storm water runoff for the Arcade Alley site in Lee's Summit, Missouri. This report reviews existing drainage conditions and evaluates proposed drainage conditions as a result of the proposed improvements to the site and its conformance with requirements for managing storm water runoff. This report is required to document proposed flow rates from the site for the City of Lee's Summit, Missouri.

Location

Arcade Alley is located at 316 SE Douglas Street in Lee's Summit, Jackson County, Missouri. The site is located in Section 5, Township 47 North, Range 31 West. The site is shown on the USGS Quadrangle Exhibit, Appendix A and the Aerial Exhibit, Appendix B.

Development

The project site is located on a 0.4-acre site owned by 316 SE Douglas, LLC. The site is currently occupied by an existing building, concrete outdoor patio spaces, and an asphalt parking lot. This project will remove the asphalt parking lot and construct a larger outdoor covered concrete patio area with amenities.

Datum

The site survey uses NAVD 88 datum.

Soils

The drainage areas on site are comprised of the following soil types according to the Natural Resources Conservation Service (NRCS) Soil Survey, Appendix C:

- Urban land, upland, 5 to 9 percent slopes

No Hydraulic Soil Group (HSG) was provided for this soil type.

Flood Insurance Rate Map (FIRM)

The site is shown on FEMA FIRM Panel 29095C0417G, Jackson County, Missouri and Incorporated Areas, effective January 20, 2017, Appendix D. The site is in Zone X, areas of minimal flood hazard outside of the 1% annual chance flooding.

Drainage Patterns

Hydrologic Methods

The existing and proposed drainage areas were modeled using Hydraflow Hydrographs by AutoCAD, Appendix E. The SCS Method was used in calculations with rainfall depths determined from the NOAA Atlas 14 Lee's Summit, Missouri, as shown in Table 1. Time of Concentration was calculated using the TR-55 Method.

Table 1 - Rainfall Depths (inches) for 24- Hour Design Storm

	1-Yr	5-Yr	10-Yr	25-Yr	50-Yr	100-Yr
Lee's Summit	3.1	4.8	5.7	7.0	8.1	9.2

Drainage Conditions

Existing Conditions

The Arcade Alley site is mostly impervious. A small, recessed island on the north side of the existing parking lot contains gravel and allows water to percolate into the soil. This area totals approximately 570 square feet or 0.01 acres. Currently, there is no underground storm water system for runoff to leave the site. All flow exits the property by overland flow. Under existing conditions, about $\frac{3}{4}$ of the property drains to the east into SE Douglas Street. The remaining $\frac{1}{4}$ of the property drains to the west into the alley between SE Douglas Street and Main Street. Curb inlets eventually collect the runoff in SE Douglas Street while grate inlets collect the runoff in the alley. No known drainage issues exist within the area. Existing drainage areas are shown in Appendix F. Table 2 describes existing drainage area conditions.

Table 2. Existing Drainage Conditions

	Area (acres)	Tc (min)	CN	1-Yr (cfs)	10-Yr (cfs)	100-Yr (cfs)
East Area	0.27	5.0	98	1.1	2.1	3.4
West Area	0.08	5.0	98	0.3	0.6	1.0

Proposed Conditions

Under proposed conditions, the Arcade Alley site will continue to drain to the east and west. A new outdoor patio area will be constructed in place of the asphalt parking lot. A canopy will be constructed over the patio area and two artificial turf areas will be installed for games. Due to the downspout configuration from the new canopy, a slightly larger area will now the west drain to the west than previously did. Drains within the new patio areas as well as roof drains from the existing building and new canopy will be drain into the rock base under the artificial turf areas. Underdrains will then drain the turf areas onto the street and alley as before.

The recessed island on the north side of the project will be reduced to approximately 110 square feet. However, the artificial turf areas total approximately 2,305 square feet. The proposed site imperviousness will be decreased with the proposed conditions. The proposed artificial turf areas will allow storm water to pass through the surface into a rock base. Additional runoff will be drained to these areas as well. Runoff will be able to collect in the void space in the rock base and can infiltrate as much as possible in the clay soils before being collected by the underdrains and routed away. The turf will act as small detention basins as well as slowing the storm water runoff from leaving the site. Proposed drainage areas are shown in Appendix G. Table 3 describes proposed drainage area conditions.

Table 3. Proposed Drainage Conditions

	Area (acres)	Tc (min)	CN	1-Yr (cfs)	10-Yr (cfs)	100-Yr (cfs)
East Area	0.25	5.0	98	1.0	1.9	3.2
West Area	0.11	5.0	98	0.5	0.8	1.4

Storm Water Quality (BMP's)

This project will not increase the imperviousness of the site and will not require detention or Best Management Practices (BMP's).

Utilities

Water

Domestic and/or fire service will not be required for the proposed outdoor patio improvements.

Sanitary Sewer

A sanitary sewer line will not be required for the proposed outdoor patio improvements.

Stormwater Sewer

Public improvement plans will not be required for the proposed outdoor patio improvements.

Permitting

U.S. Army Corps of Engineers

Since there are no potential wetlands on the site and there is no blue line stream on the site, permitting through the U.S. Army Corps of Engineers will not be required.

Federal Emergency Management Agency (FEMA)

There are no FEMA floodplains on the site; permitting through FEMA will not be required.

Missouri Department of Natural Resources (MoDNR)

The project disturbs less than 1.0 acre; therefore, a Notice of Intent (NOI) and Storm Water Pollution Prevention Plan (SWPPP) will not be prepared.

Missouri Department of Conservation (MDC)

The MDC will be contacted during the MoDNR NOI permitting process. It is not anticipated that there will be any concerns.

Missouri Historical Society (MHS)

The MHS will be contacted during the NOI permitting process. Since there are no historical buildings on site, it is not anticipated that there will be any concerns.

Summary

The Arcade Alley project at 316 SE Douglas Street is in Lee's Summit, Jackson County, Missouri. The site improvements include a new, larger outdoor patio area and amenities. Detention and water quality is not required on the site since the site's imperviousness is not increasing.

Appendix A - USGS Quadrangle



Overland Park, KS - 913.3179300

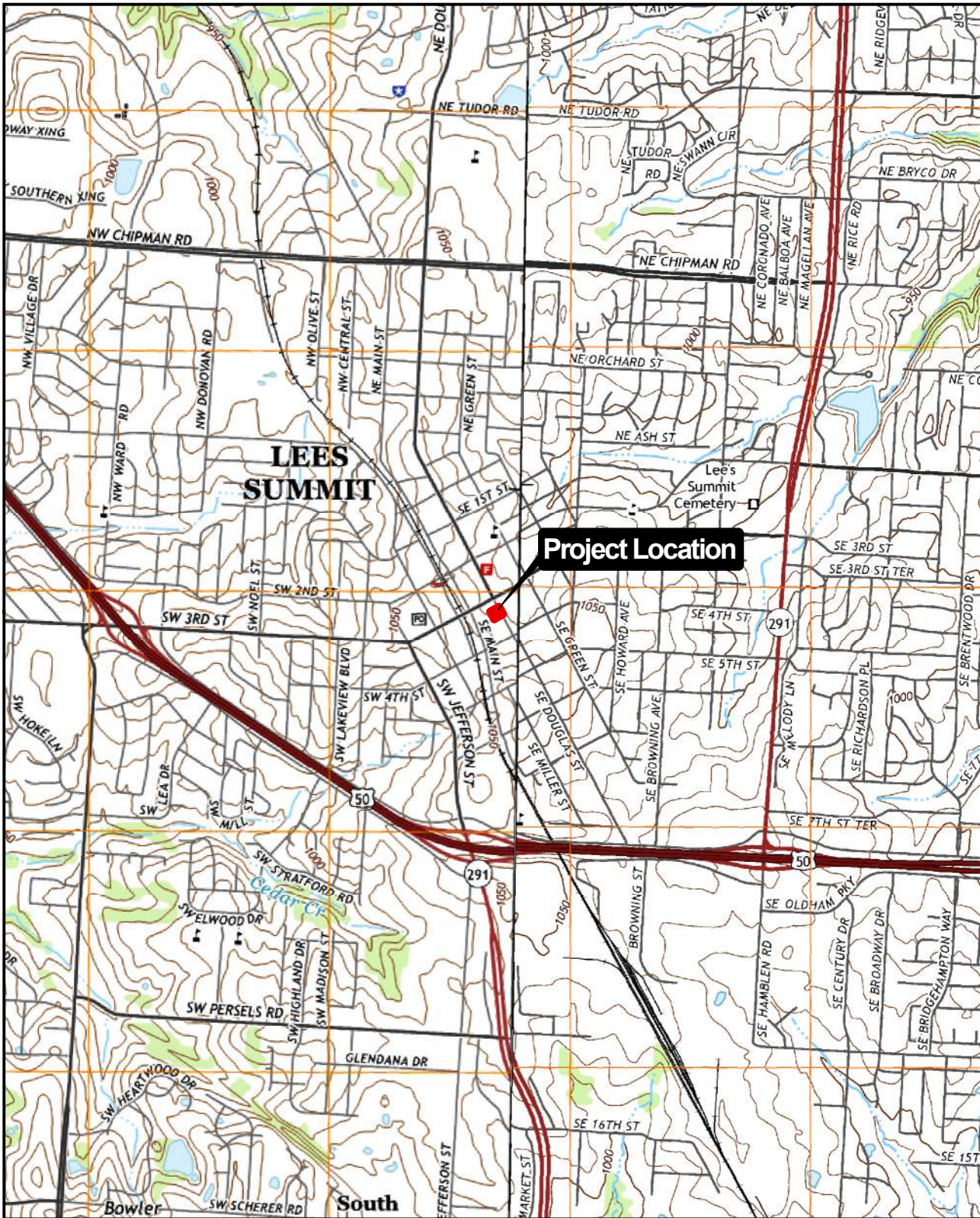

USGS QUAD EXHIBIT
ARCADE ALLEY
LEE'S SUMMIT, MISSOURI

©2022
 MKEC Engineering
 All Rights Reserved
 www.mkec.com
 These drawings and their contents, including, but not limited to, all concepts, designs, & ideas are the exclusive property of MKEC Engineering (MKEC), and may not be used or reproduced in any way without the express consent of MKEC.

SEC: 05
 TWP: T47N
 RNG: R31W

PROJECT NO. 2202010333

DATE Jun 2022

SCALE 1"=2000'

DESIGNED DRAWN CHECKED
 LES LES KLA

NO.	REVISION	DATE

SHEET NO.

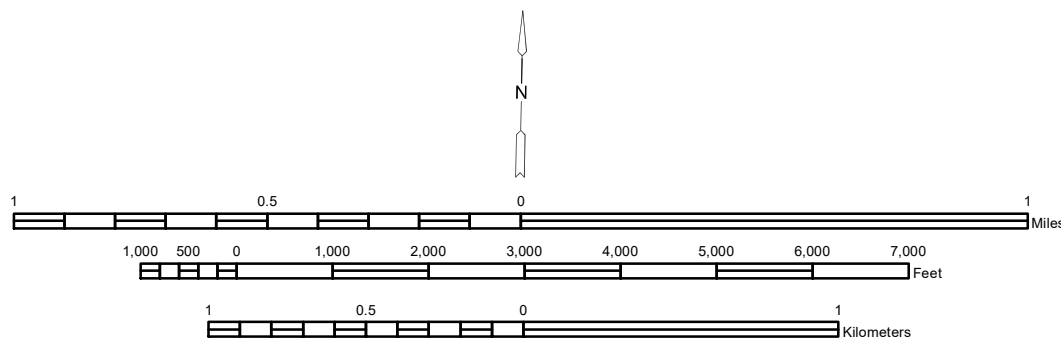

Appendix B - Aerial Photograph



Source: Esri, Maxar, GeoEye, Earthstar Geographics, CNES/Airbus DS, USDA, USGS, AeroGRID, IGN, and the GIS User Community



SEC: 05
TWP: T47N
RNG: R31W

1"=100' / 1:1200



©2022
MKEC Engineering
All Rights Reserved
www.mkec.com
These drawings and their contents, including, but not limited to, all concepts, designs, & ideas are the exclusive property of MKEC Engineering (MKEC), and may not be used or reproduced in any way without the express consent of MKEC.



Overland Park, KS - 913.317.9390

**AERIAL EXHIBIT
ARCADE ALLEY
LEE'S SUMMIT, MISSOURI**

PROJECT NO. 2202010333	DATE: June 2022	SHEET NO.
DRAWN BY: LES	DESIGNED BY: LES	APPROVED BY: KLA
		1 OF 1

Appendix C - Soils Survey

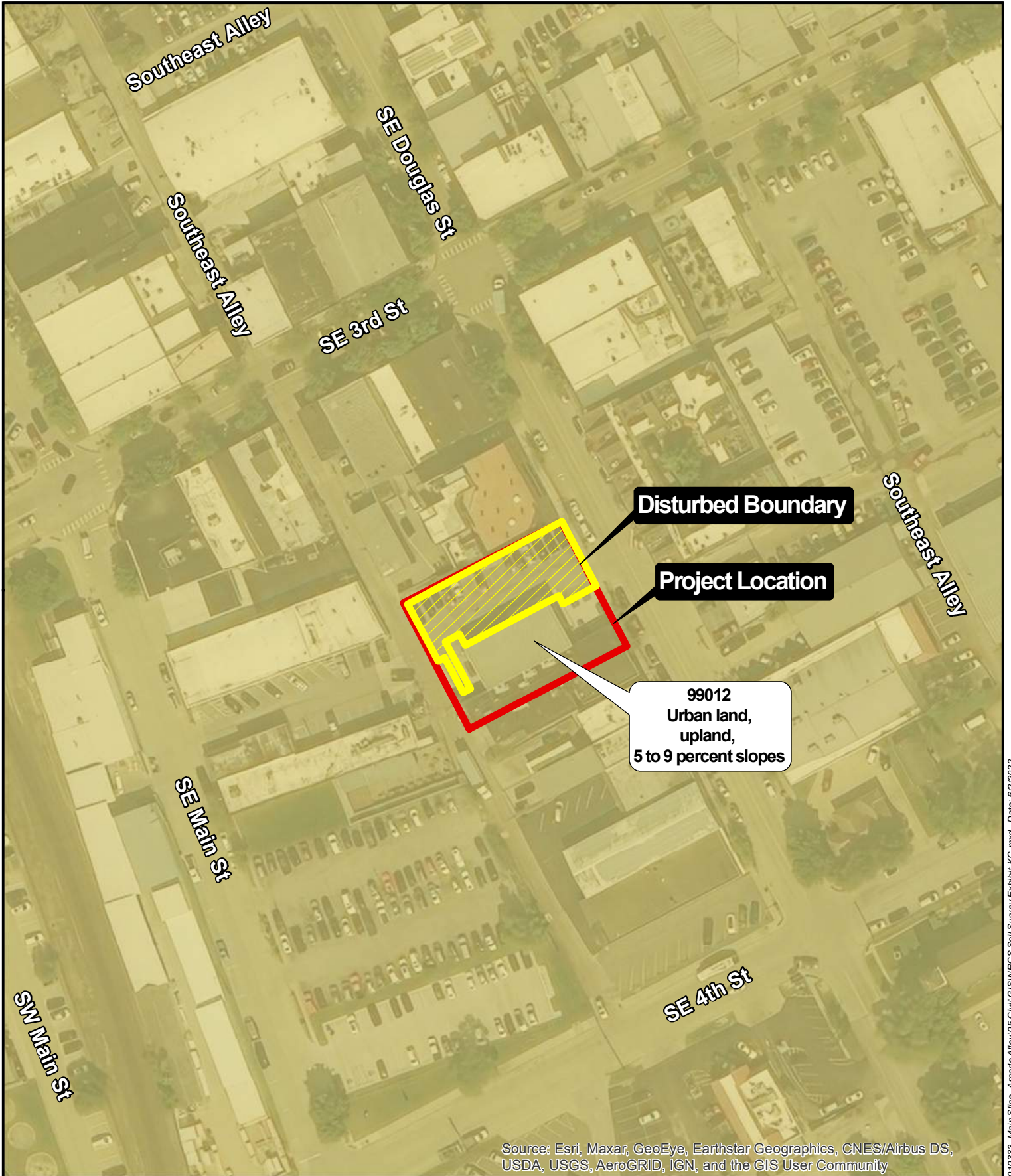

Source: Esri, Maxar, GeoEye, Earthstar Geographics, CNES/Airbus DS, USDA, USGS, AeroGRID, IGN, and the GIS User Community



SEC: 05
TWP: T47N
RNG: R31W

1"=100' / 1:1200



©2022
MKEC Engineering
All Rights Reserved
www.mkec.com
These drawings and their contents,
including, but not limited to, all
concepts, designs, & ideas are the
exclusive property of MKEC
Engineering (MKEC), and may not be
used or reproduced in any way without
the express consent of MKEC.



Overland Park, KS - 913.317.9390

**NRCS SOIL SURVEY EXHIBIT
ARCADE ALLEY
LEE'S SUMMIT, MISSOURI**

PROJECT NO. 2202010333	DATE: June 2022	SHEET NO.
DRAWN BY: LES	DESIGNED BY: LES	APPROVED BY: KLA
		1 OF 1

Appendix D - FEMA FIRM



Project Location

NATIONAL FLOOD INSURANCE PROGRAM NFIP	PANEL 0417G		
	FIRM		
	FLOOD INSURANCE RATE MAP		
	JACKSON COUNTY, MISSOURI AND INCORPORATED AREAS		
	PANEL 417 OF 625 (SEE MAP INDEX FOR FIRM PANEL LAYOUT)		
	<u>CONTAINS:</u>		
	COMMUNITY	NUMBER	PANEL
	LEE'S SUMMIT, CITY OF	290174	0417
	SUFFIX		
	G		
<p>Notice to User: The Map Number shown below should be used when placing map orders; the Community Number shown above should be used on insurance applications for the subject community.</p>			
 <p>MAP NUMBER 29095C0417G MAP REVISED JANUARY 20, 2017 Federal Emergency Management Agency</p>			

SEC: 05
TWP: T47N
RNG: R31W

1"=400' / 1:4800

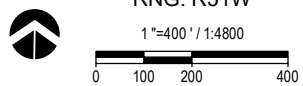

©2022
MKEC Engineering
All Rights Reserved
www.mkec.com

These drawings and their contents, including, but not limited to, all concepts, designs, & ideas are the exclusive property of MKEC Engineering (MKEC), and may not be used or reproduced in any way without the express consent of MKEC.



MKEC

Overland Park, KS - 913.317.9390

**FEMA FIRM EXHIBIT
ARCADE ALLEY
LEE'S SUMMIT, MISSOURI**

PROJECT NO. 2202010333	DATE: June 2022	SHEET NO.
DRAWN BY: LES	DESIGNED BY: LES	APPROVED BY: KLA
		1 OF 1

Appendix E - Hydraflow Hydrograph Outputs

Hydrograph Summary Report

Hydraflow Hydrographs Extension for AutoCAD® Civil 3D® 2018 by Autodesk, Inc. v2018.3

Hyd. No.	Hydrograph type (origin)	Peak flow (cfs)	Time interval (min)	Time to Peak (min)	Hyd. volume (cuft)	Inflow hyd(s)	Maximum elevation (ft)	Total strge used (cuft)	Hydrograph Description
1	SCS Runoff	1.129	2	716	2,635	-----	-----	-----	East Area
2	SCS Runoff	0.334	2	716	781	-----	-----	-----	West Area
4	SCS Runoff	1.045	2	716	2,440	-----	-----	-----	East Area
5	SCS Runoff	0.460	2	716	1,074	-----	-----	-----	West Area

Hydrograph Report

Hydraflow Hydrographs Extension for AutoCAD® Civil 3D® 2018 by Autodesk, Inc. v2018.3

Friday, 06 / 10 / 2022

Hyd. No. 1

East Area

Hydrograph type	= SCS Runoff	Peak discharge	= 1.129 cfs
Storm frequency	= 1 yrs	Time to peak	= 11.93 hrs
Time interval	= 2 min	Hyd. volume	= 2,635 cuft
Drainage area	= 0.270 ac	Curve number	= 98
Basin Slope	= 0.0 %	Hydraulic length	= 0 ft
Tc method	= User	Time of conc. (Tc)	= 5.00 min
Total precip.	= 3.10 in	Distribution	= Type II
Storm duration	= 24 hrs	Shape factor	= 484

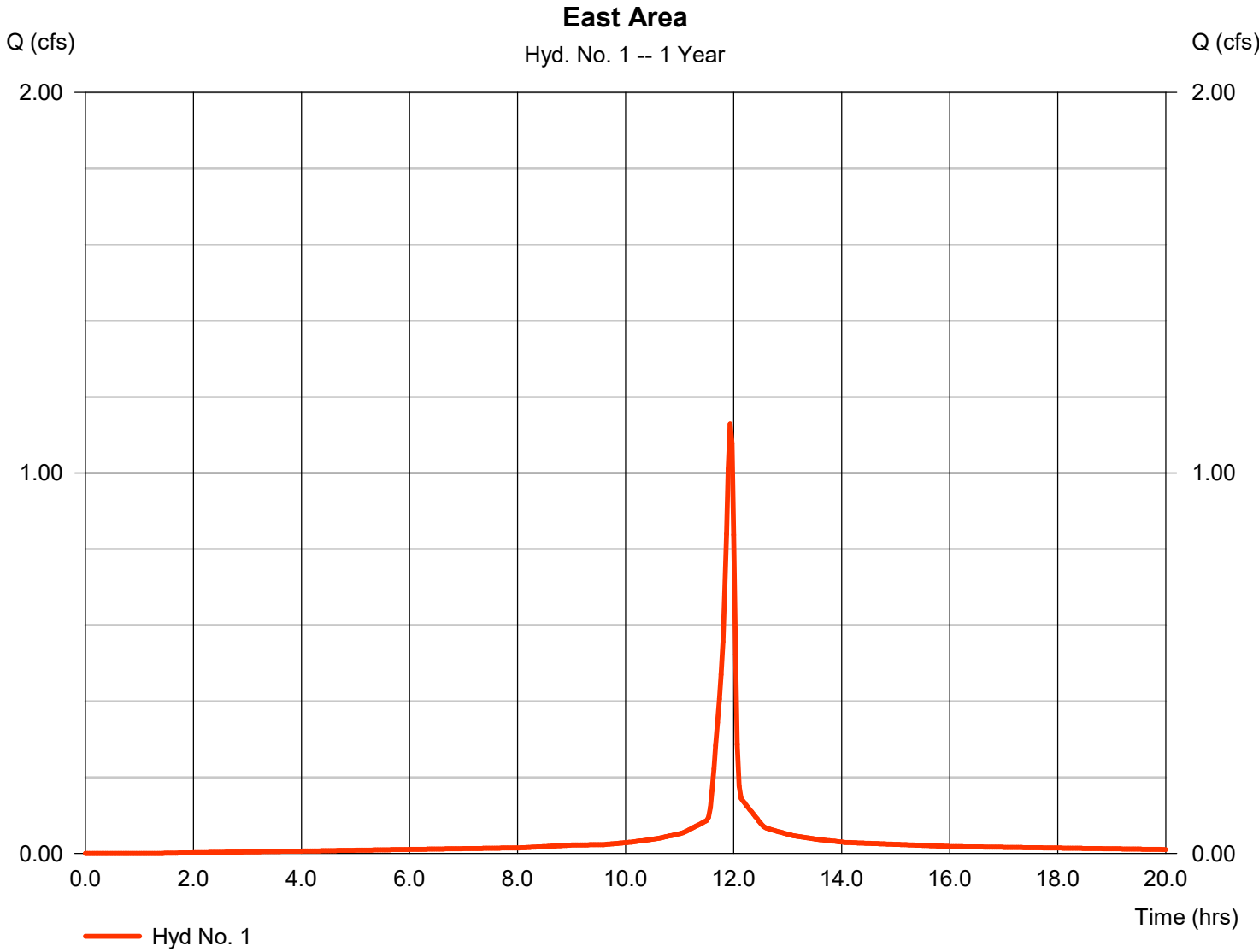

Hydrograph Report

Hyd. No. 2

West Area

Hydrograph type	= SCS Runoff	Peak discharge	= 0.334 cfs
Storm frequency	= 1 yrs	Time to peak	= 11.93 hrs
Time interval	= 2 min	Hyd. volume	= 781 cuft
Drainage area	= 0.080 ac	Curve number	= 98
Basin Slope	= 0.0 %	Hydraulic length	= 0 ft
Tc method	= User	Time of conc. (Tc)	= 5.00 min
Total precip.	= 3.10 in	Distribution	= Type II
Storm duration	= 24 hrs	Shape factor	= 484

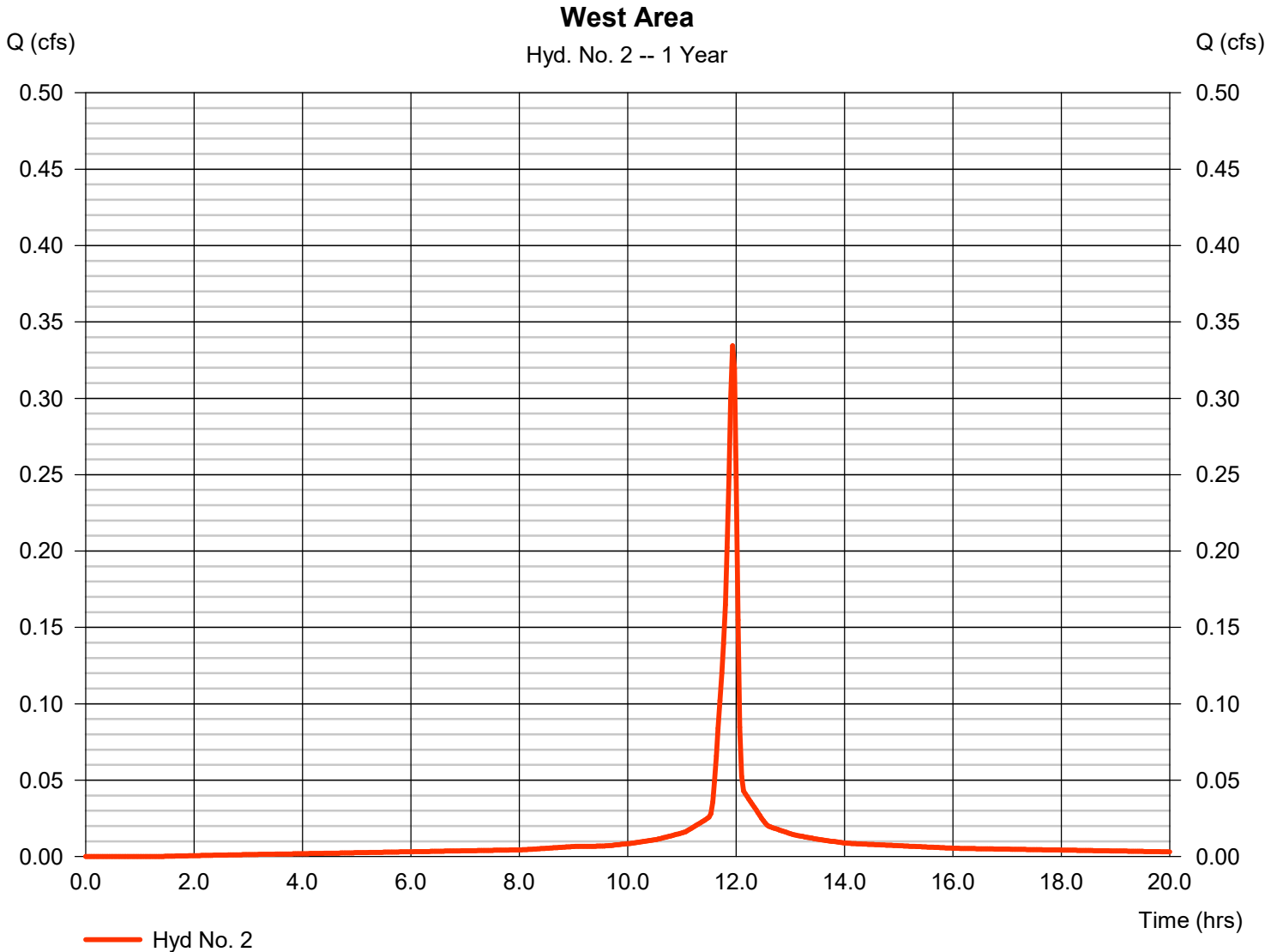

Hydrograph Report

Hyd. No. 4

East Area

Hydrograph type	= SCS Runoff	Peak discharge	= 1.045 cfs
Storm frequency	= 1 yrs	Time to peak	= 11.93 hrs
Time interval	= 2 min	Hyd. volume	= 2,440 cuft
Drainage area	= 0.250 ac	Curve number	= 98
Basin Slope	= 0.0 %	Hydraulic length	= 0 ft
Tc method	= User	Time of conc. (Tc)	= 5.00 min
Total precip.	= 3.10 in	Distribution	= Type II
Storm duration	= 24 hrs	Shape factor	= 484

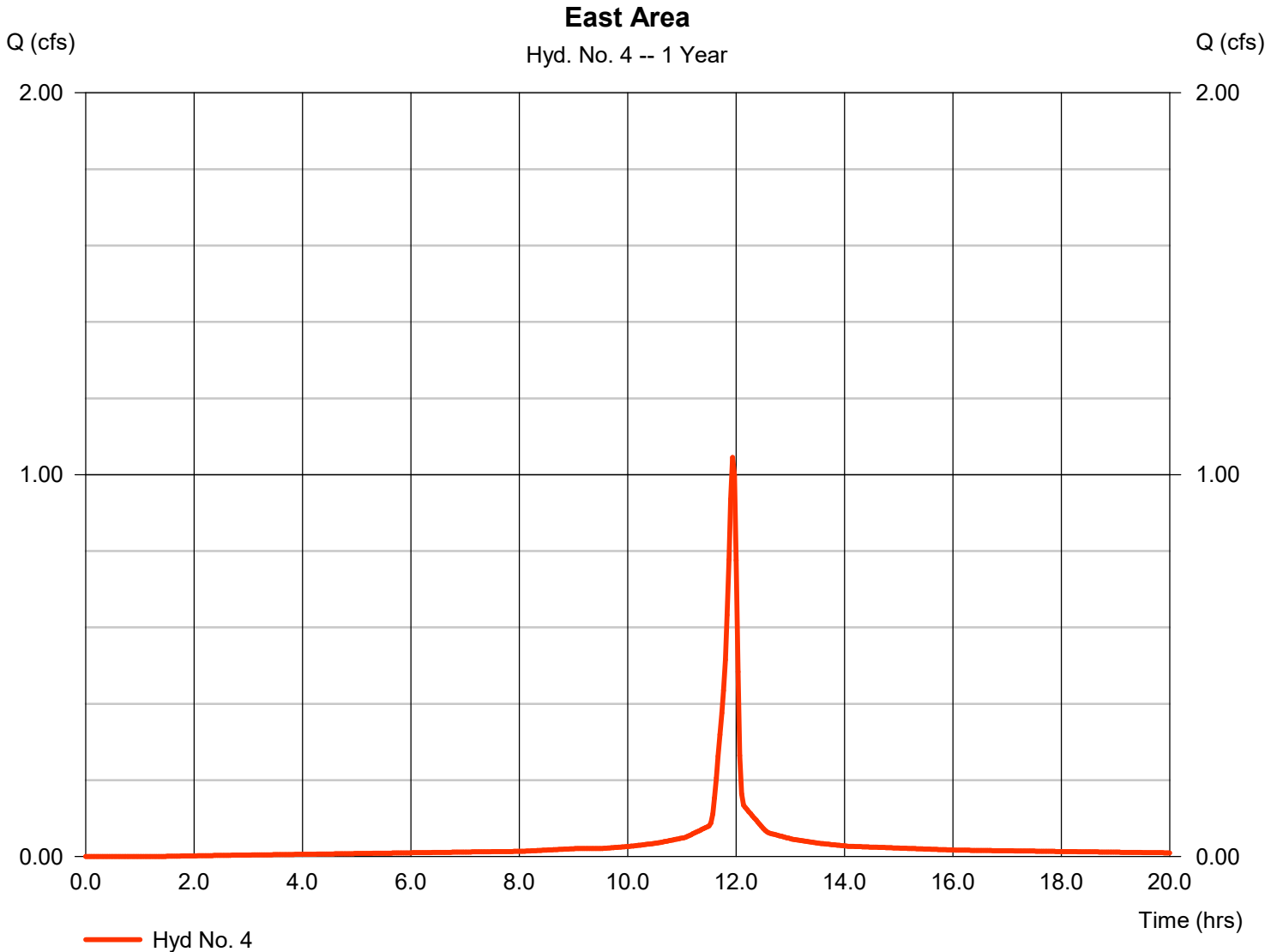

Hydrograph Report

Hydraflow Hydrographs Extension for AutoCAD® Civil 3D® 2018 by Autodesk, Inc. v2018.3

Friday, 06 / 10 / 2022

Hyd. No. 5

West Area

Hydrograph type	= SCS Runoff	Peak discharge	= 0.460 cfs
Storm frequency	= 1 yrs	Time to peak	= 11.93 hrs
Time interval	= 2 min	Hyd. volume	= 1,074 cuft
Drainage area	= 0.110 ac	Curve number	= 98
Basin Slope	= 0.0 %	Hydraulic length	= 0 ft
Tc method	= User	Time of conc. (Tc)	= 5.00 min
Total precip.	= 3.10 in	Distribution	= Type II
Storm duration	= 24 hrs	Shape factor	= 484

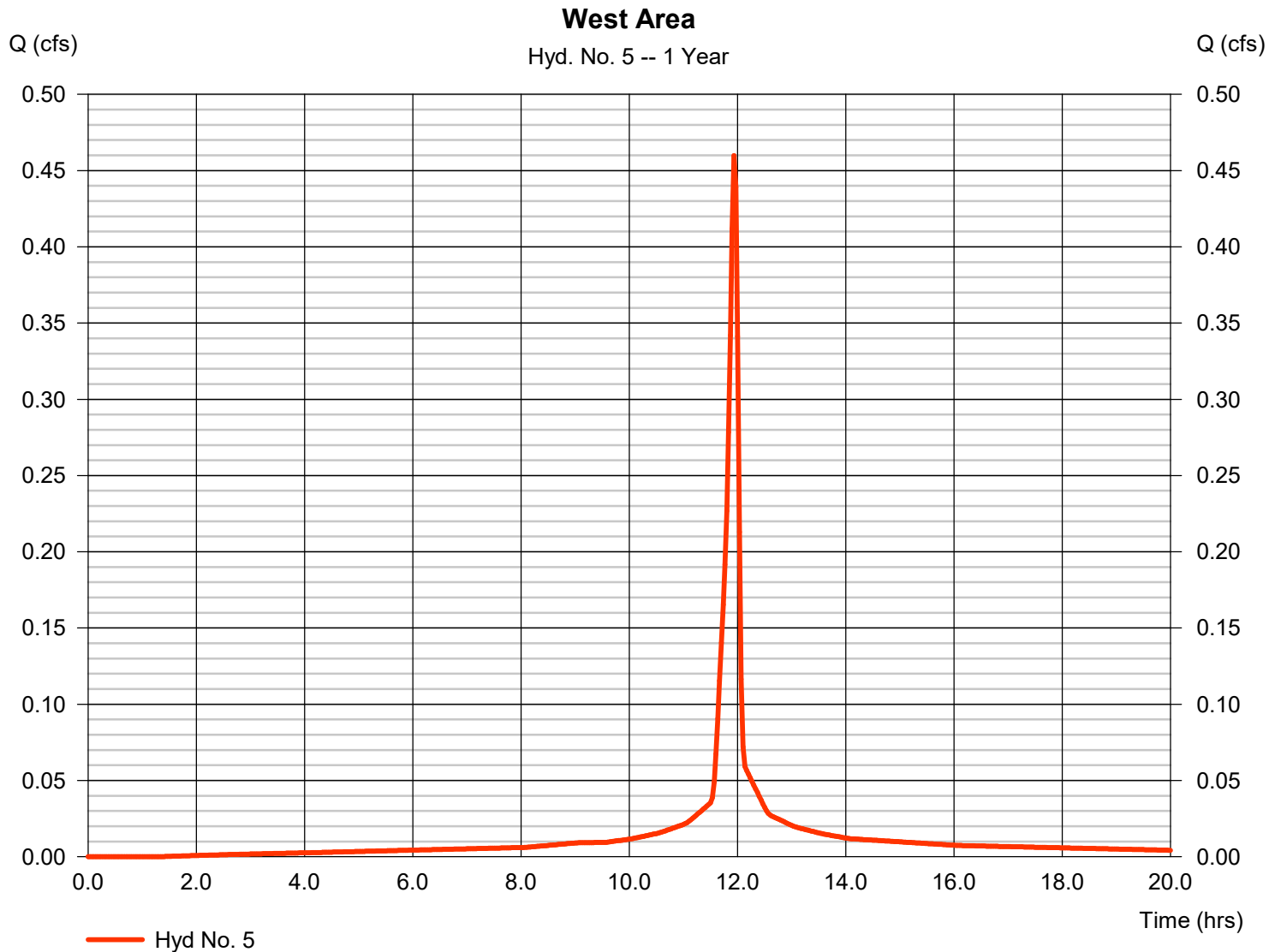

Hydrograph Summary Report

Hydraflow Hydrographs Extension for AutoCAD® Civil 3D® 2018 by Autodesk, Inc. v2018.3

Hyd. No.	Hydrograph type (origin)	Peak flow (cfs)	Time interval (min)	Time to Peak (min)	Hyd. volume (cuft)	Inflow hyd(s)	Maximum elevation (ft)	Total strge used (cuft)	Hydrograph Description	
1	SCS Runoff	2.083	2	716	4,991	-----	-----	-----	East Area	
2	SCS Runoff	0.617	2	716	1,479	-----	-----	-----	West Area	
4	SCS Runoff	1.929	2	716	4,622	-----	-----	-----	East Area	
5	SCS Runoff	0.849	2	716	2,034	-----	-----	-----	West Area	
Arcade Alley Hydraflow.gpw					Return Period: 10 Year			Friday, 06 / 10 / 2022		

Hydrograph Report

Hydraflow Hydrographs Extension for AutoCAD® Civil 3D® 2018 by Autodesk, Inc. v2018.3

Friday, 06 / 10 / 2022

Hyd. No. 1

East Area

Hydrograph type	= SCS Runoff	Peak discharge	= 2.083 cfs
Storm frequency	= 10 yrs	Time to peak	= 11.93 hrs
Time interval	= 2 min	Hyd. volume	= 4,991 cuft
Drainage area	= 0.270 ac	Curve number	= 98
Basin Slope	= 0.0 %	Hydraulic length	= 0 ft
Tc method	= User	Time of conc. (Tc)	= 5.00 min
Total precip.	= 5.67 in	Distribution	= Type II
Storm duration	= 24 hrs	Shape factor	= 484

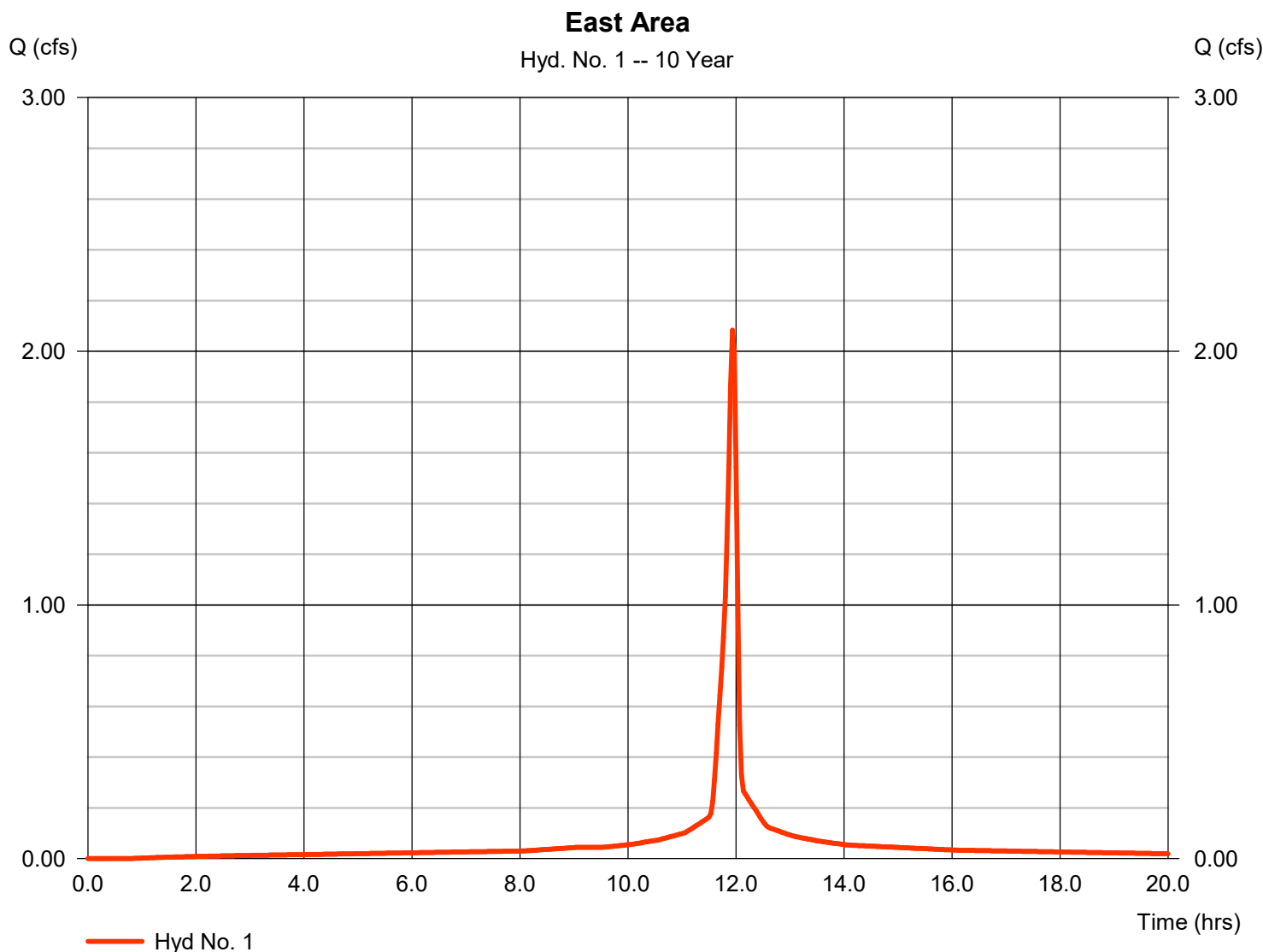

Hydrograph Report

Hydraflow Hydrographs Extension for AutoCAD® Civil 3D® 2018 by Autodesk, Inc. v2018.3

Friday, 06 / 10 / 2022

Hyd. No. 2

West Area

Hydrograph type	= SCS Runoff	Peak discharge	= 0.617 cfs
Storm frequency	= 10 yrs	Time to peak	= 11.93 hrs
Time interval	= 2 min	Hyd. volume	= 1,479 cuft
Drainage area	= 0.080 ac	Curve number	= 98
Basin Slope	= 0.0 %	Hydraulic length	= 0 ft
Tc method	= User	Time of conc. (Tc)	= 5.00 min
Total precip.	= 5.67 in	Distribution	= Type II
Storm duration	= 24 hrs	Shape factor	= 484

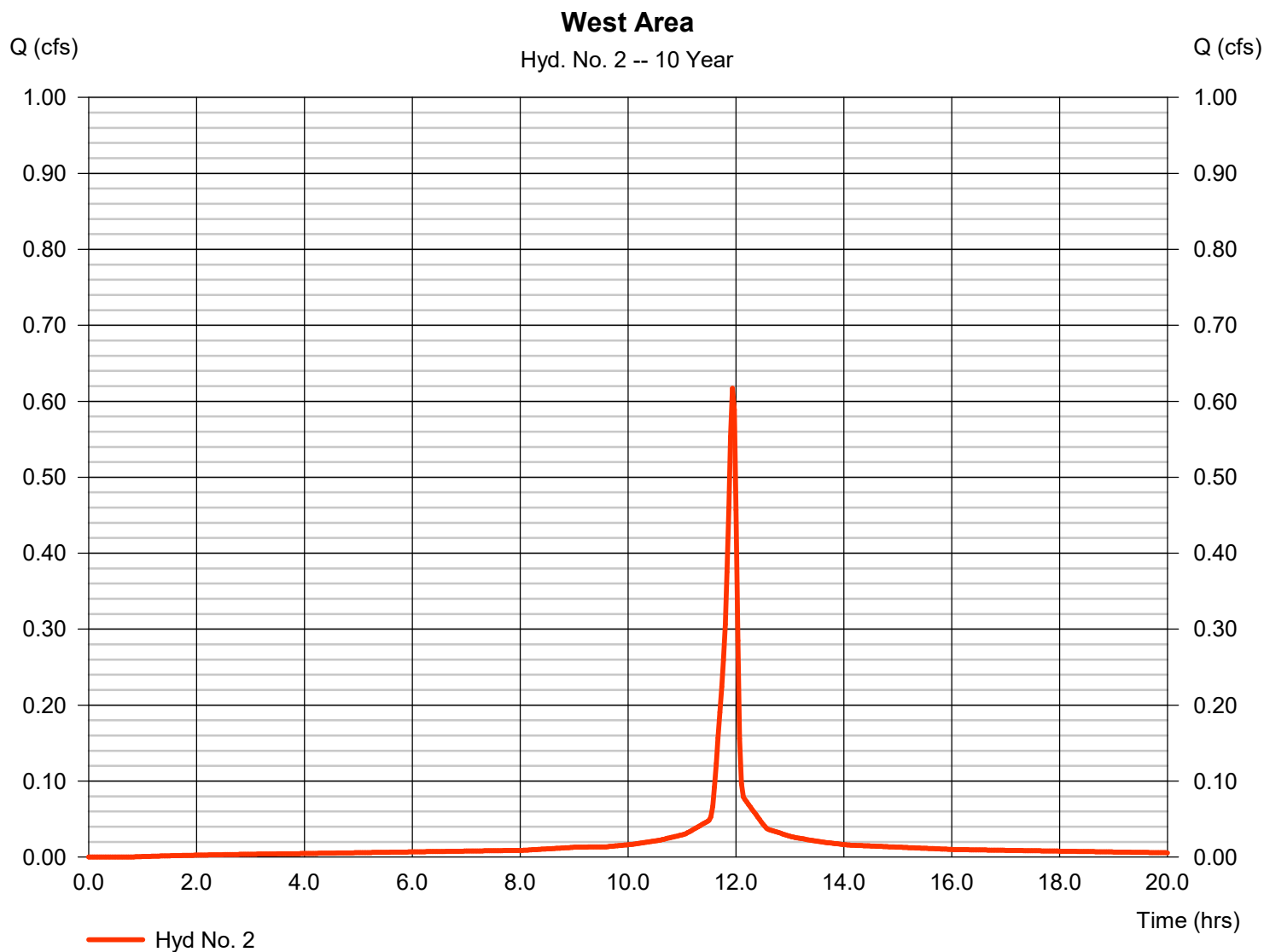

Hydrograph Report

Hyd. No. 4

East Area

Hydrograph type	= SCS Runoff	Peak discharge	= 1.929 cfs
Storm frequency	= 10 yrs	Time to peak	= 11.93 hrs
Time interval	= 2 min	Hyd. volume	= 4,622 cuft
Drainage area	= 0.250 ac	Curve number	= 98
Basin Slope	= 0.0 %	Hydraulic length	= 0 ft
Tc method	= User	Time of conc. (Tc)	= 5.00 min
Total precip.	= 5.67 in	Distribution	= Type II
Storm duration	= 24 hrs	Shape factor	= 484

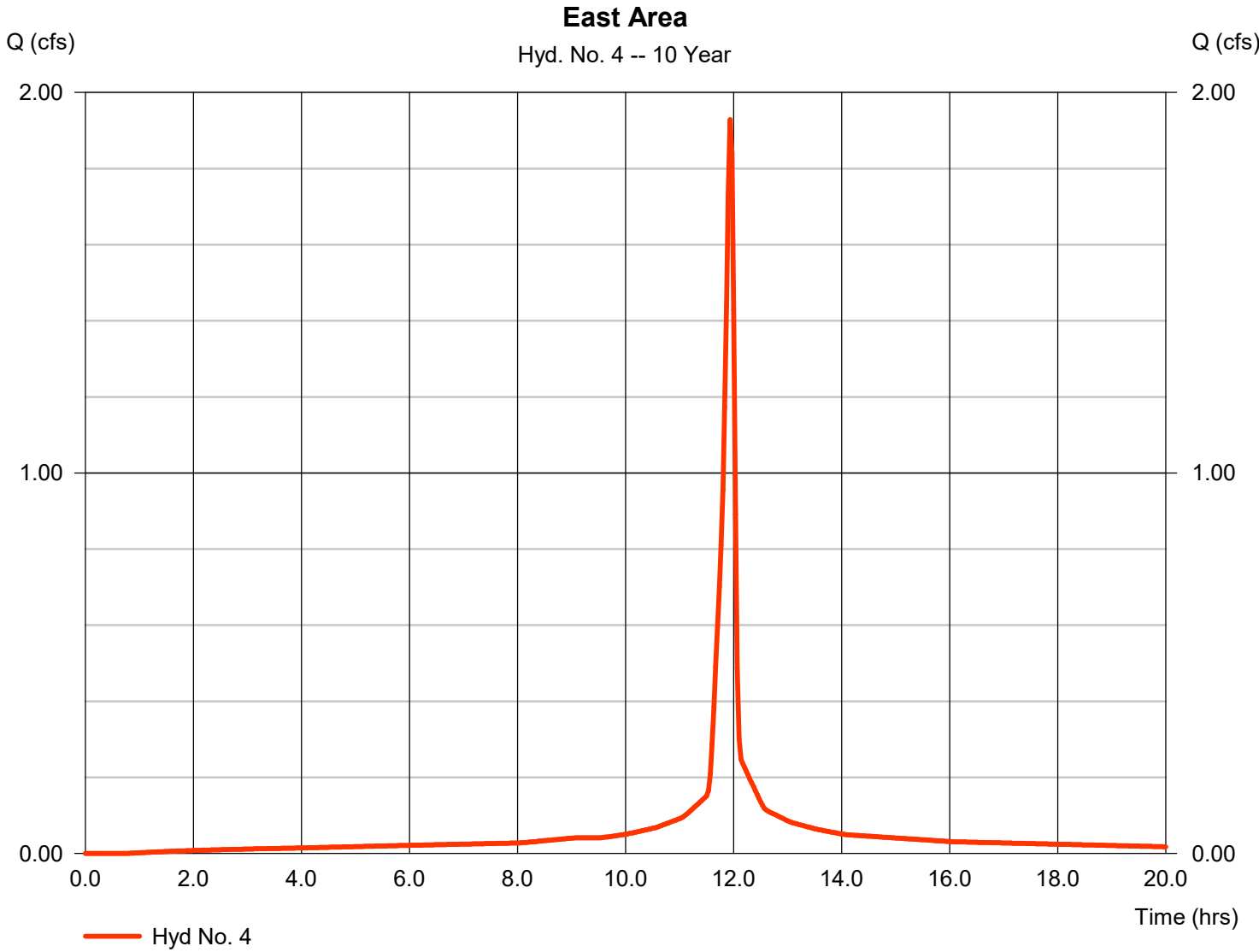

Hydrograph Report

Hydraflow Hydrographs Extension for AutoCAD® Civil 3D® 2018 by Autodesk, Inc. v2018.3

Friday, 06 / 10 / 2022

Hyd. No. 5

West Area

Hydrograph type	= SCS Runoff	Peak discharge	= 0.849 cfs
Storm frequency	= 10 yrs	Time to peak	= 11.93 hrs
Time interval	= 2 min	Hyd. volume	= 2,034 cuft
Drainage area	= 0.110 ac	Curve number	= 98
Basin Slope	= 0.0 %	Hydraulic length	= 0 ft
Tc method	= User	Time of conc. (Tc)	= 5.00 min
Total precip.	= 5.67 in	Distribution	= Type II
Storm duration	= 24 hrs	Shape factor	= 484

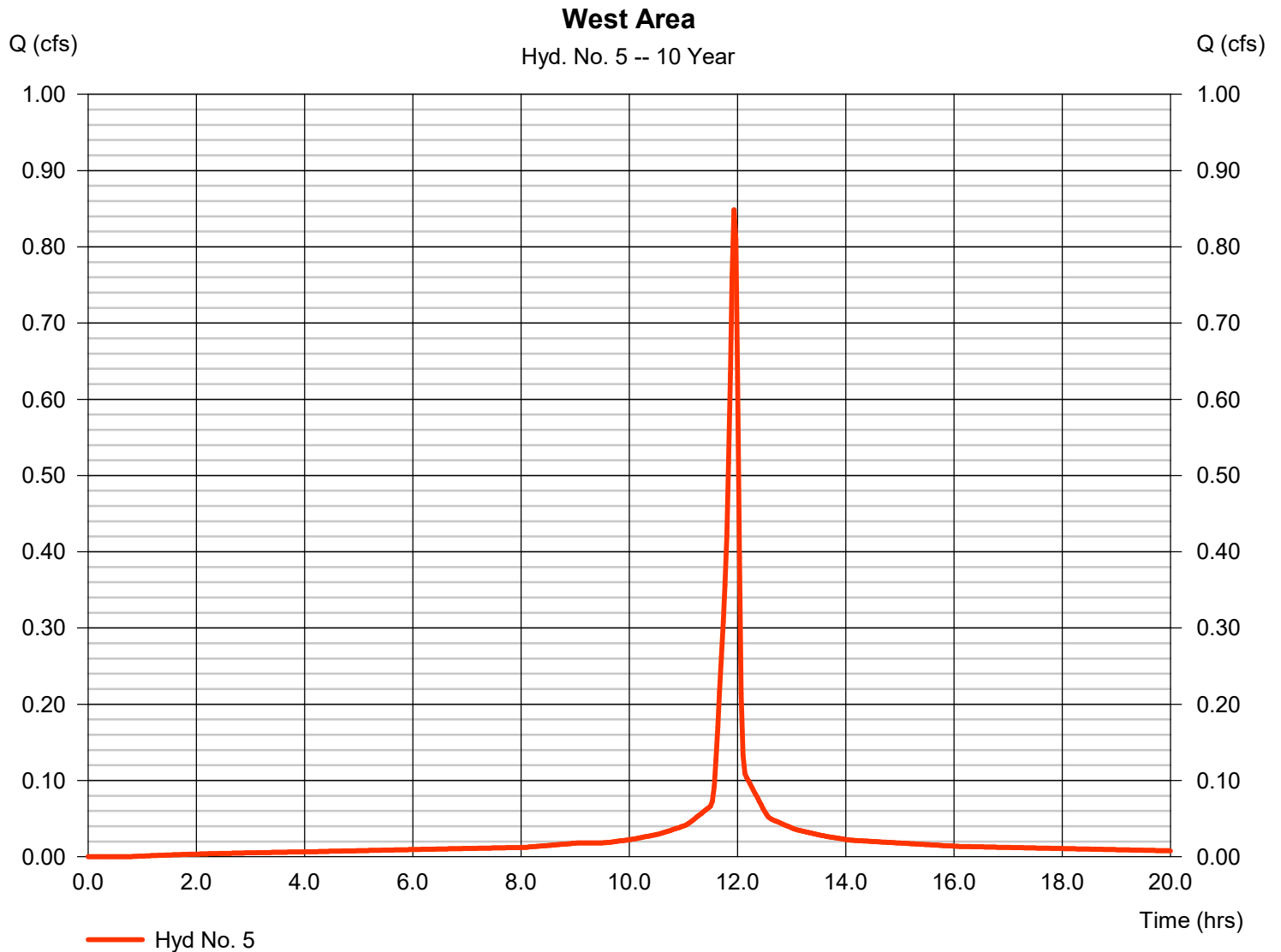

Hydrograph Summary Report

Hydraflow Hydrographs Extension for AutoCAD® Civil 3D® 2018 by Autodesk, Inc. v2018.3

Hyd. No.	Hydrograph type (origin)	Peak flow (cfs)	Time interval (min)	Time to Peak (min)	Hyd. volume (cuft)	Inflow hyd(s)	Maximum elevation (ft)	Total strge used (cuft)	Hydrograph Description	
1	SCS Runoff	3.403	2	716	8,269	-----	-----	-----	East Area	
2	SCS Runoff	1.008	2	716	2,450	-----	-----	-----	West Area	
4	SCS Runoff	3.151	2	716	7,657	-----	-----	-----	East Area	
5	SCS Runoff	1.386	2	716	3,369	-----	-----	-----	West Area	
Arcade Alley Hydraflow.gpw					Return Period: 100 Year			Friday, 06 / 10 / 2022		

Hydrograph Report

Hydraflow Hydrographs Extension for AutoCAD® Civil 3D® 2018 by Autodesk, Inc. v2018.3

Friday, 06 / 10 / 2022

Hyd. No. 1

East Area

Hydrograph type	= SCS Runoff	Peak discharge	= 3.403 cfs
Storm frequency	= 100 yrs	Time to peak	= 11.93 hrs
Time interval	= 2 min	Hyd. volume	= 8,269 cuft
Drainage area	= 0.270 ac	Curve number	= 98
Basin Slope	= 0.0 %	Hydraulic length	= 0 ft
Tc method	= User	Time of conc. (Tc)	= 5.00 min
Total precip.	= 9.24 in	Distribution	= Type II
Storm duration	= 24 hrs	Shape factor	= 484

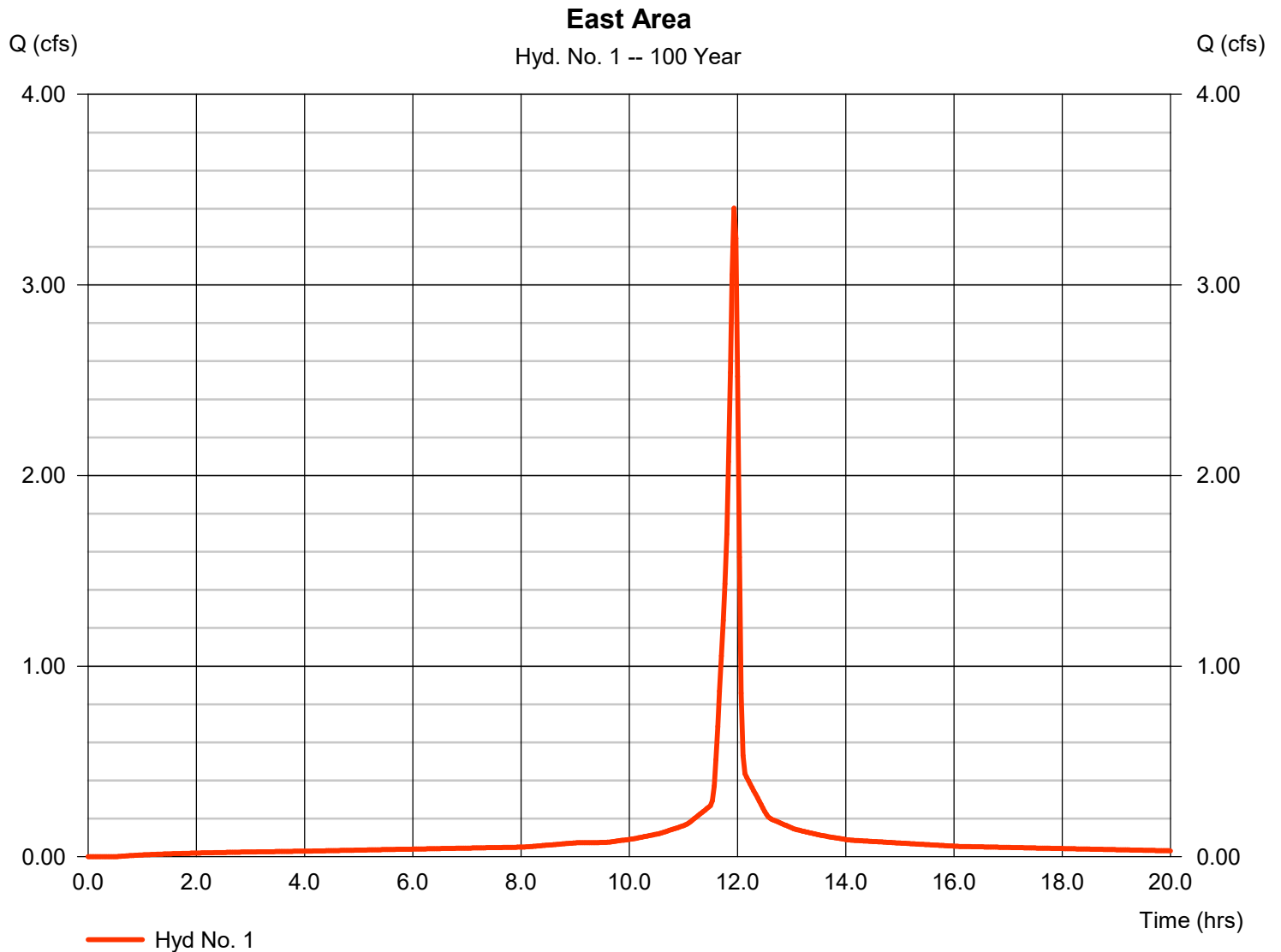

Hydrograph Report

Hydraflow Hydrographs Extension for AutoCAD® Civil 3D® 2018 by Autodesk, Inc. v2018.3

Friday, 06 / 10 / 2022

Hyd. No. 2

West Area

Hydrograph type	= SCS Runoff	Peak discharge	= 1.008 cfs
Storm frequency	= 100 yrs	Time to peak	= 11.93 hrs
Time interval	= 2 min	Hyd. volume	= 2,450 cuft
Drainage area	= 0.080 ac	Curve number	= 98
Basin Slope	= 0.0 %	Hydraulic length	= 0 ft
Tc method	= User	Time of conc. (Tc)	= 5.00 min
Total precip.	= 9.24 in	Distribution	= Type II
Storm duration	= 24 hrs	Shape factor	= 484

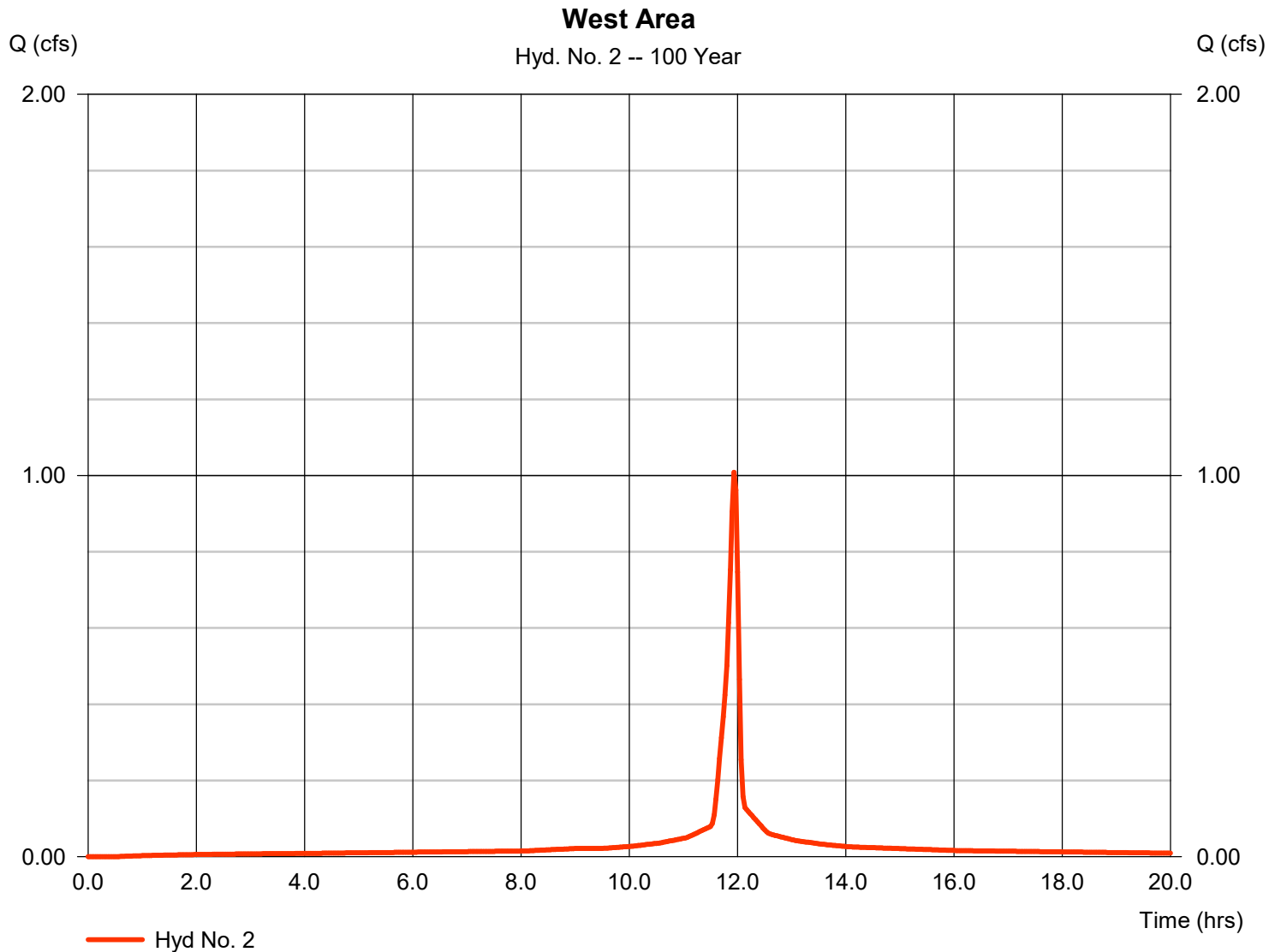

Hydrograph Report

Hydraflow Hydrographs Extension for AutoCAD® Civil 3D® 2018 by Autodesk, Inc. v2018.3

Friday, 06 / 10 / 2022

Hyd. No. 4

East Area

Hydrograph type	= SCS Runoff	Peak discharge	= 3.151 cfs
Storm frequency	= 100 yrs	Time to peak	= 11.93 hrs
Time interval	= 2 min	Hyd. volume	= 7,657 cuft
Drainage area	= 0.250 ac	Curve number	= 98
Basin Slope	= 0.0 %	Hydraulic length	= 0 ft
Tc method	= User	Time of conc. (Tc)	= 5.00 min
Total precip.	= 9.24 in	Distribution	= Type II
Storm duration	= 24 hrs	Shape factor	= 484

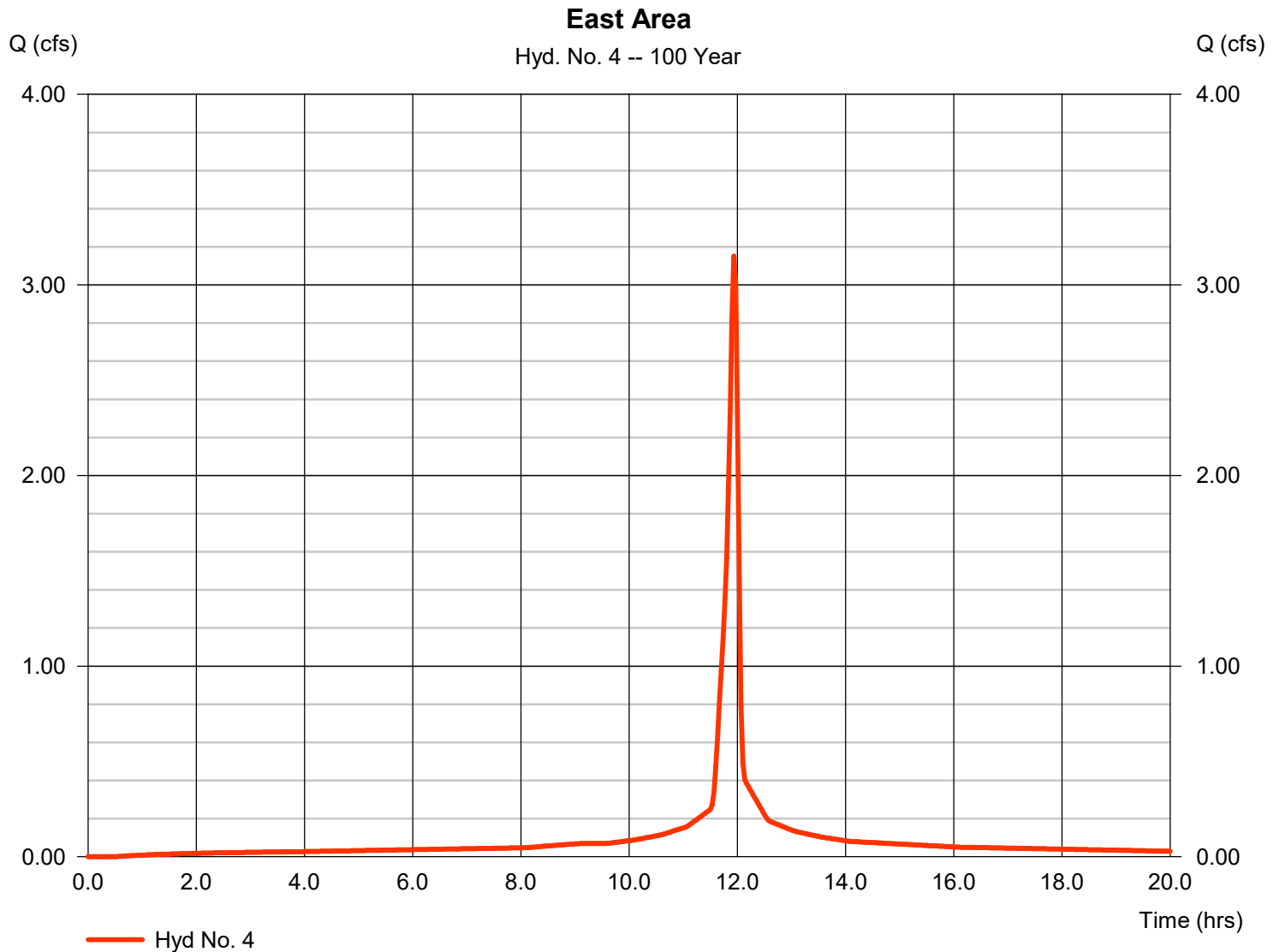

Hydrograph Report

Hydraflow Hydrographs Extension for AutoCAD® Civil 3D® 2018 by Autodesk, Inc. v2018.3

Friday, 06 / 10 / 2022

Hyd. No. 5

West Area

Hydrograph type	= SCS Runoff	Peak discharge	= 1.386 cfs
Storm frequency	= 100 yrs	Time to peak	= 11.93 hrs
Time interval	= 2 min	Hyd. volume	= 3,369 cuft
Drainage area	= 0.110 ac	Curve number	= 98
Basin Slope	= 0.0 %	Hydraulic length	= 0 ft
Tc method	= User	Time of conc. (Tc)	= 5.00 min
Total precip.	= 9.24 in	Distribution	= Type II
Storm duration	= 24 hrs	Shape factor	= 484

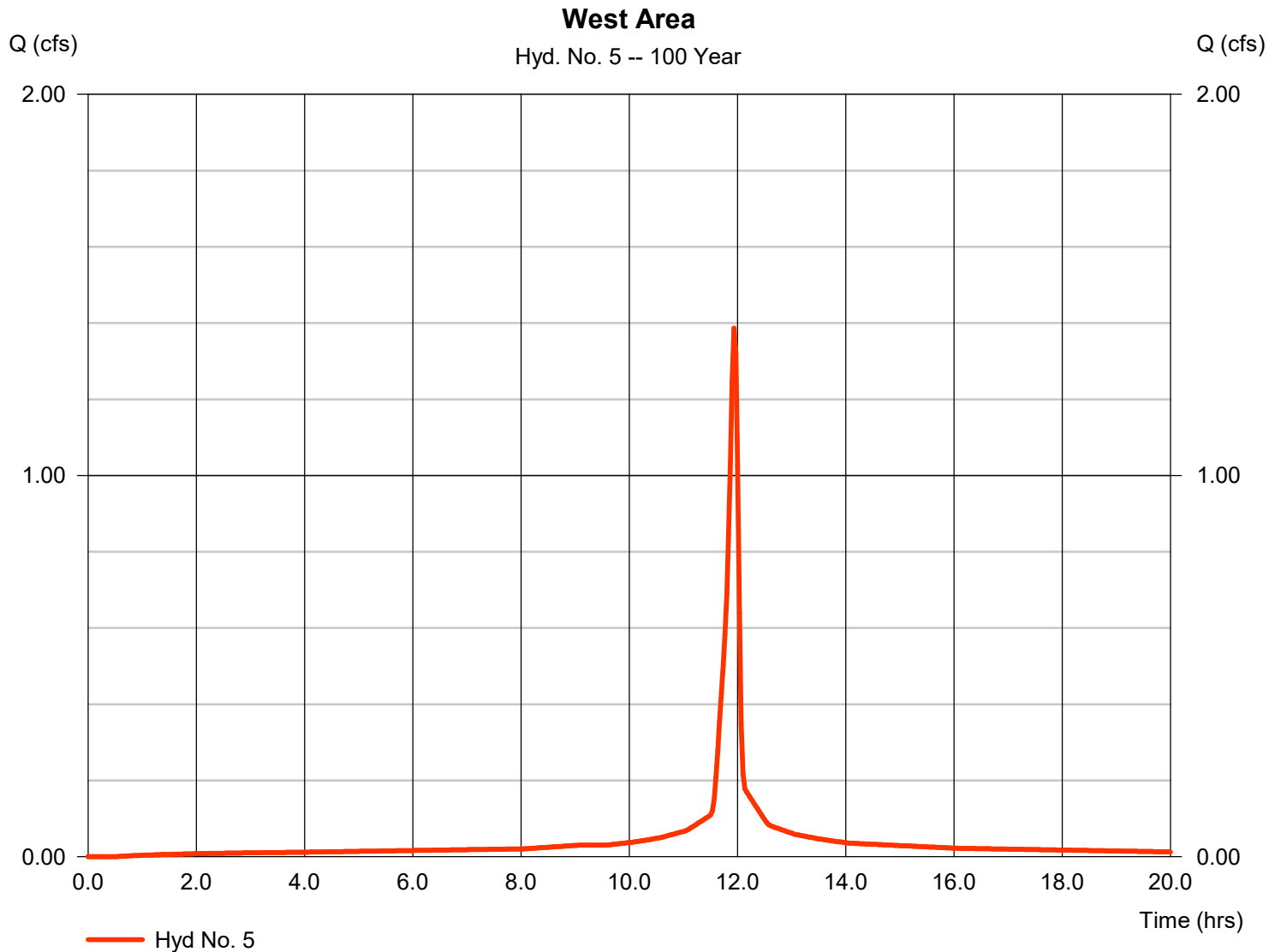

Appendix F - Existing Drainage Areas

DRAINAGE REPORT FOR
ARCADE ALLEY
316 SE DOUGLAS STREET, LEE'S SUMMIT, MO 64063

©2022
MKEC Engineering
All Rights Reserved
www.mkec.com
These drawings and their contents, including, but not limited to, all concepts, designs, & ideas are the exclusive property of MKEC Engineering (MKEC), and may not be used or reproduced in any way without the express consent of MKEC.

EXISTING WATERSHED MAP

PROJECT NO. 2202010333

DATE 08.17.2022

SCALE 1" = 10'

DESIGNED PAH DRAWN PAH CHECKED BSH

1	PDP Comments	07.13.22
NO.	REVISION	DATE

SHEET NO.

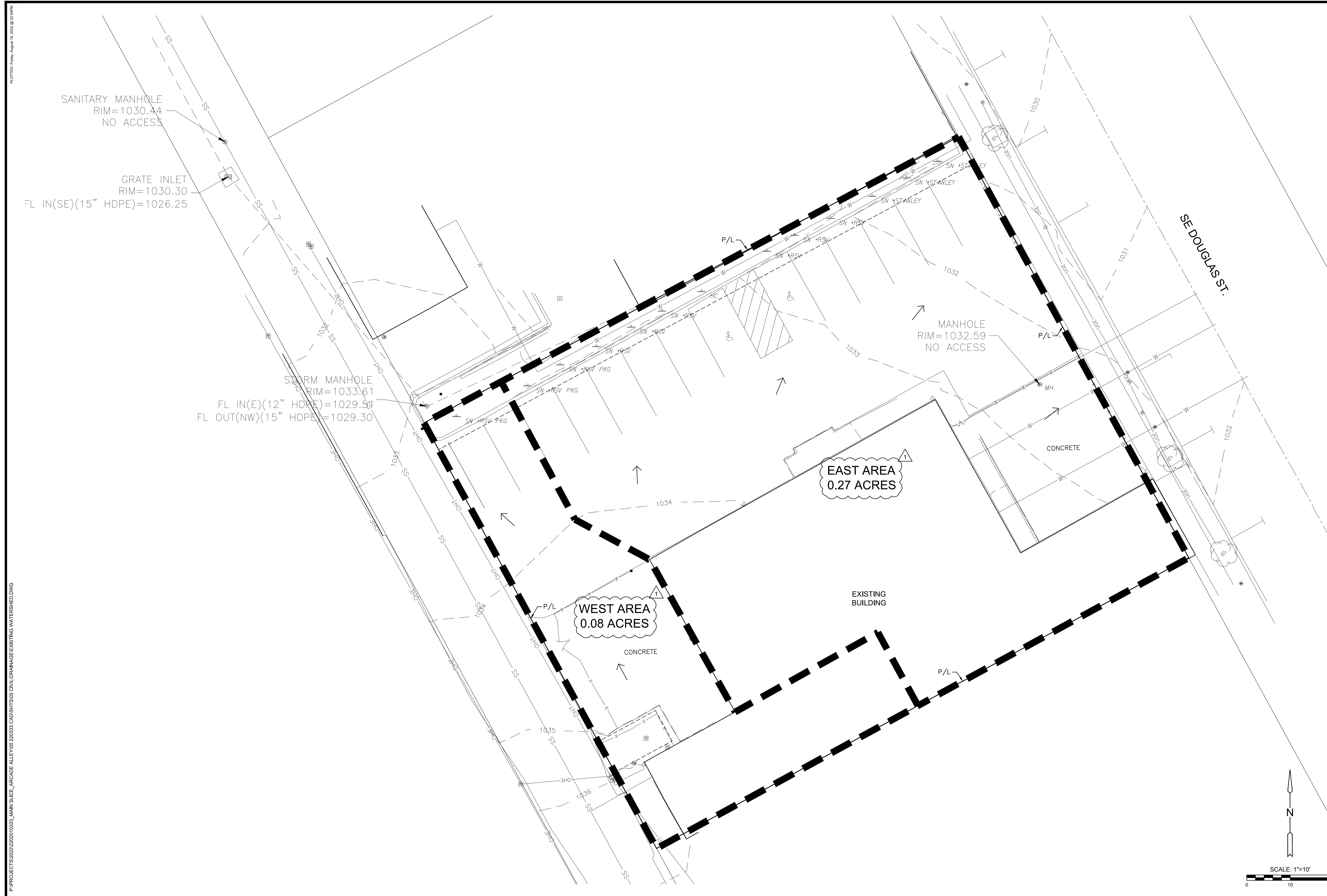

P:\PROJECTS\2022\202010333_MAIN_SLICE_ARCADE_ALLEY\DWG\202010333_CAD\SHOTS\05_CIVIL\DRAINAGE\EXISTING WATERSHED.DWG

PLOTTED: Friday, August 19, 2022 @ 02:59PM

Appendix G - Proposed Drainage Areas

DRAINAGE REPORT FOR
VS SERVICES WAREHOUSE
6220 KANSAS AVENUE, KANSAS CITY, KS 66111

©2022
MKEC Engineering
All Rights Reserved
www.mkec.com
These drawings and their contents, including, but not limited to, all concepts, designs, & ideas are the exclusive property of MKEC Engineering (MKEC), and may not be used or reproduced in any way without the express consent of MKEC.

PROPOSED WATERSHED MAP

PROJECT NO. 2102010863

DATE 08.17.2022

SCALE 1" = 10'

DESIGNED PAH DRAWN PAH CHECKED BSH

1	PDP Comments	07.13.22
NO.	REVISION	DATE

SHEET NO.

1 OF 1

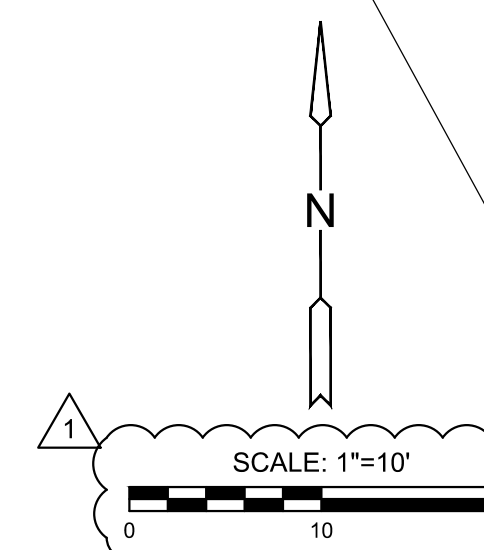
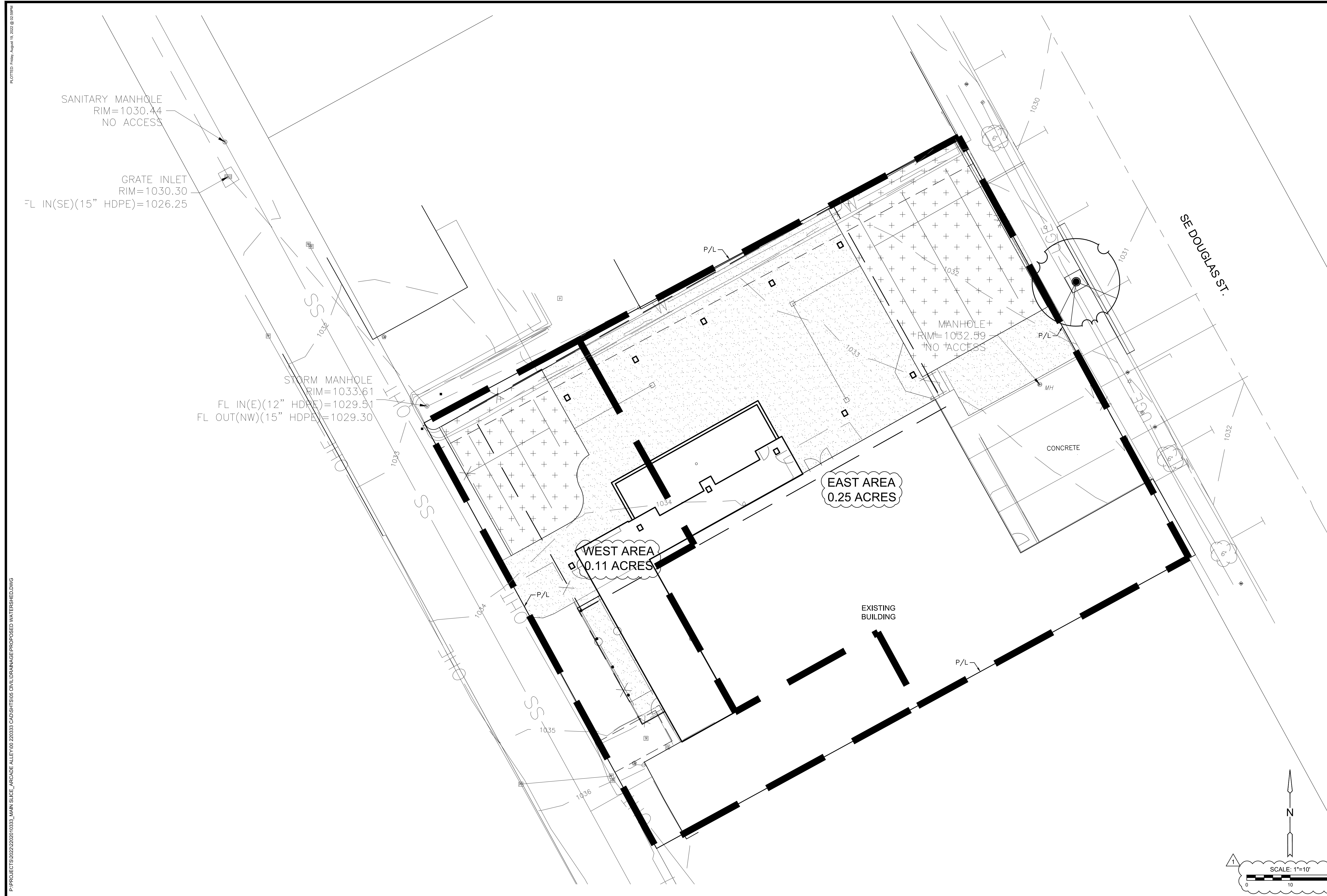

P:\PROJECTS\2022\2102010863_MAIN_SLICE_ARCADE_ALLEY\00_2023\33_CAD\SHOTS\05_CIVIL\DRAINAGE\PROPOSED_WATERSHED.DWG
 PLOTTED: Friday, August 19, 2022 @ 02:59PM