



**Report
on
Structural Stability of Engineered Lumber in Fire Conditions**
Project Number: 08CA33476
File Number: NC10412

**Underwriters Laboratories Inc.
333 Pfingsten Road, Northbrook, IL 60062**

**Submitted to
Chicago Fire Department, City of Chicago
January 30, 2009**

Prepared by:

Mark S. Izydorek
Lead Engineering Associate
Fire Protection Division

Patrick A. Zeeveld, P.E.
Senior Project Engineer
Fire Protection Division

Matthew D. Samuels
Associate Project Engineer
Fire Protection Division

James P. Smyser
Associate Project Engineer
Fire Protection Division

Reviewed by:

Pravinray D. Gandhi, PhD, PE
Director
Corporate Research

Bob Backstrom
Senior Staff Engineer
Corporate Research

Underwriters Laboratories Inc. (UL) its trustees, employees, sponsors, and contractors, make no warranties, express or implied, nor assume and expressly disclaim any legal liability or responsibility to any person for any loss or damage arising out of or in connection with the interpretation, application, or use of or inability to use, any information, data, apparatus, product, or process disclosed in this Report. This Report cannot be modified or reproduced, in part, without the prior written permission of Underwriters Laboratories Inc.

Executive Summary

This report describes the fire resistive performance of three assemblies tested as part of a fire research and education program in cooperation with The City of Chicago Fire Department.

Introduction

This project was conducted by Underwriters Laboratories Inc (UL) to develop supplementary data on Structural Stability of Engineered Lumber in Fire Conditions in support of the DHS (Department of Homeland Security) sponsored research under the AFG (Assistance to Firefighter Grant) as detailed in the report dated September 30, 2008. In addition to the formal report, an internet based outreach to the fire service was developed and can be viewed at:

<http://content.learnshare.com/courses/73/187716/player.html>

The research resulted in identification of specific construction features not addressed by the original study. Thus, three additional assemblies, representing these construction features were tested to complement the original research.

Test Plan

A total of three fire tests were conducted on test assemblies representing floor–ceiling constructions so as to develop comparable fire performance data among assemblies. All the test assemblies were intended to represent typical residential construction.

The first assembly was constructed with parallel chord trusses with metal gusset connections as the structural components with a regular 1/2" gypsum board ceiling and included the following unique features:

- Recessed lighting fixture penetrations in the ceiling
- HVAC supply and return penetrations in the ceiling
- HVAC duct work in the interstitial space above the ceiling
- Metal gusset connection on the bottom cord
- AFG grant sponsored test # 5 was similarly constructed without the unique features noted above.

The second assembly was constructed with parallel chord truss with glued connections as the structural components. This assembly was similar to the AFG grant sponsored test # 6 with the exception that this test did not include a ceiling.

The third assembly was constructed with parallel chord truss with metal gusset connections as the structural components and included simulated stairwell framing.

The construction details of the three test assemblies are summarized in Table E-1 and detailed in Test Records 1 through 3.

Table E-1 - Summary of Test Samples

Test Assembly No.	Supports	Ceiling	Floor or Roof
1	Parallel chord truss with steel gusset plate connections, 14 inch deep @ 24 inch centers with bottom chord splices, can lights and duct work	1/2 inch regular gypsum wallboard	23/32 inch OSB subfloor, carpet padding & carpet
2	Parallel chord truss with glued connections, 14 inch deep @ 24 inch centers	None	23/32 inch OSB subfloor, carpet padding & carpet
3	Parallel chord truss with steel gusset plate connections, 14 inch deep @ 24 inch centers with simulated staircase and bottom chord splices	None	23/32 inch OSB subfloor, carpet padding & carpet

The three fire tests complied with the requirements of ASTM E119 but the applied structural load was non-traditional. Typically, a uniform load is applied on the floor to fully stress the supporting structural members. This load is generally higher than the minimum design load of 40 psf specified by the building code for residential construction. For the tests described in this report, the load placed on the samples was intended to represent typical conditions during a fire. A load of 40 psf was placed along two of the four edges of the floor – ceiling assemblies to represent loads around a perimeter of a room. On each sample, two 300 pound concentrated loads were placed near the center of the sample. A mannequin, intended to simulate fire service personnel, represented each concentrated load.

Standard ASTM E119, Fire Tests of Building and Construction Materials, describes a fire test method that establishes benchmark fire resistance performance between different types of building assemblies. For floor-ceiling assemblies, the standard requires a minimum 180 square foot sample prohibit the passage of flame through the sample and limit the temperature rise at specific locations as the sample while the sample supports a load and is exposed to a standardized fire. The standardized fire represents a fully developed fire within a residential or commercial structure with temperatures reaching 1000 °F at 5 minutes and 1700 °F at 60 minutes.

Test Results

The results of the ASTM E119 fire tests are expressed in terms of hours such as 1/2 hour, 1 hour or 2 hour rated assemblies. These time ratings are not intended to convey the actual time a specific structure will withstand an actual fire event due to differences in building configuration and construction, fuel load, and ventilation. However, the results from ASTM E119 test method enable a useful benchmark to compare the fire resistance performance of test assemblies.

For unrestrained floor-ceiling assemblies such as the tested assemblies, ASTM E119 includes the following Conditions of Acceptance:

1. The sample shall support the applied load without developing conditions that would result in flaming of cotton waste place on the floor surface.
2. Any temperature measured on the surface of the floor shall not increase more than 325 °F and the average temperature measured on the surface of the floor shall not increase more than 250 °F.

The results of the three fire tests in terms of the ASTM E119 Conditions of Acceptance are summarized in Table E-2.

Table E-2 - Summary of Test Results ASTM E119

Test Assembly No.	Time of 250°F avg. temperature rise on surface of floor (min:sec)	Time of 325°F max. temperature rise on surface of floor (min:sec)	Flame passage through floor (min:sec)	Collapse (min:sec)	Fire resistance rating (min)
1	*	*	26:00	30:08	26
2	12:30	11:15	11:45	13:06	11
3	10:45	5:00	11:30	13:20	5

Notes:

* - This condition was not achieved during the fire test.

In addition to the fire resistance rating determined by the Conditions of Acceptance in ASTM E119, a finish rating is typically published for fire resistive assemblies with combustible supports such as the tested samples. The finished rating is defined as the time when the first occurrence of either:

1. Temperature measured on the face of the combustible supports nearest to the fire increases more than 325 °F; or
2. Average temperature measured on the face of the combustible supports nearest the fire increases more than 250 °F.

Several fire test standards similar to ASTM E119 such as ISO 834:1 (Fire-resistance tests – Elements of building construction – Part 1: General requirements) define load bearing capacity as the elapsed time that a test sample is able to maintain its ability to support the applied load during the fire test. The ability to support the applied load is determined when both:

1. Deflection exceeds: $\frac{L^2}{400d}$; and
2. When the deflection exceeds $\frac{L}{30}$, the Rate of Deflection exceeds: $\frac{L^2}{9000d}$

where L is the clear span measured in millimeters and d is the distance from the extreme fiber of the design compression zone to the extreme fiber of the design tensile zone of the structural element as measured in millimeters.

Other significant data obtained during the fire tests included observation of the conditions of the ceiling and floor surfaces, temperatures in the concealed space above the ceiling membrane and deflections of the floor and roof surfaces.

The finish rating and the load bearing capacity of Benchmark assemblies from the AFG sponsored project and the three tested assemblies are summarized in Table E-3

Table E-3 - Summary of Significant Events in Addition to ASTM E119 Conditions of Acceptance

Test Assembly No.	Initial falling of ceiling material (More than 1 ft²) (min:sec)	Average temperature on unexposed surface of ceiling at initial falling (°F)	Finish rating (min:sec)	Load bearing Capacity (min)
Benchmark1 ¹	No ceiling	No Ceiling	00:45	18
Benchmark2 ²	16:00	559	12:15	25
Benchmark3 ³	16:30	519	10:45	24
Benchmark4 ⁴	23:30	605	15:30	45
Benchmark5 ⁵	74:00**	1109	74:00**	80
1	17:15	646	13:00	24
2	No ceiling	No ceiling	00:15	10
3	No ceiling	No ceiling	00:30	5

** - plaster ceiling in contact with furnace thermocouples at 51 minutes

Notes:

1 – Benchmark 1 data represents a combustible floor-ceiling assembly of typical unprotected legacy construction (2 x 10) without a ceiling

2 – Benchmark 2 data represents a combustible floor-ceiling assembly of typical modern construction of parallel chord truss with glued connections with a ½ thick regular gypsum board ceiling

3 – Benchmark 3 data represents a combustible floor-ceiling assembly of typical modern construction of parallel chord truss with steel gusset connections with a ½ thick regular gypsum board ceiling

4 – Benchmark 4 data represents a combustible floor-ceiling assembly of typical protected legacy construction (2 x 10) with a ½ inch regular gypsum board ceiling

5 – Benchmark 5 data represents a combustible floor-ceiling assembly of typical protected legacy construction (2 x 10) with a ¾ inch metal lath and plaster ceiling

Research Findings

The following summarizes the key findings documented in this report:

From the previous AFG sponsored project, it was determined that the fire containment performance (load bearing capacity) of a combustible floor-ceiling assembly representing typical unprotected legacy construction (2 x 10) without a ceiling was 18 minutes. The time duration was based upon the performance of the assembly when exposed to the time-temperature curve defined in Standard ASTM E119. This was defined as the benchmark (Benchmark 1) fire resistance performance of traditional exposed lumber construction typically found in lowest floor above basement or crawl spaces.

- The fire containment performance of Test Assembly 1 representing modern steel gusset truss construction with a ceiling with penetrations was 6 minutes more than the benchmark performance.
- The fire containment performance of Assembly 2 representing unprotected modern glued truss construction was 8 minutes less than the benchmark performance.
- The fire containment performance of Assembly 3 representing unprotected modern steel gusset construction with stairwell framing was 13 minutes less than the benchmark performance.

From the previous AFG sponsored project, it was determined that the fire containment performance (load bearing capacity) of a combustible floor-ceiling assembly representing typical modern construction of parallel chord truss with glued connections with a ½ thick regular gypsum board ceiling was 25 minutes. The time duration was based upon the performance of the assembly when exposed to the time-temperature curve defined in Standard ASTM E119. This was defined as the benchmark (Benchmark 2) performance of modern glued joint truss construction with a regular gypsum board ceiling typically found in floors above living spaces.

- The fire containment performance of Assembly 2 without the ceiling was 15 minutes less than the benchmark performance.

From the previous AFG sponsored project, it was determined that the fire containment performance (load bearing capacity) of a combustible floor-ceiling assembly representing typical modern construction of parallel chord truss with steel gusset connections with a ½ thick regular gypsum board ceiling was 24 minutes. The time duration was based upon the performance of the assembly when exposed to the time-temperature curve defined in

Standard ASTM E119. This was defined as the benchmark (Benchmark 3) performance of modern metal gusset truss construction with a regular gypsum board ceiling typically found in floors above living spaces.

- The fire containment performance of Assembly 3 without the ceiling and framed with a stairwell opening was 19 minutes less than the benchmark performance.

From the previous AFG sponsored project, it was determined that the fire containment performance (load bearing capacity) of a combustibile floor-ceiling assembly representing typical protected legacy construction (2 x 10) with a ½ inch regular gypsum board ceiling was 45 minutes. The time duration was based upon the performance of the assembly when exposed to the time-temperature curve defined in Standard ASTM E119. This was defined as the benchmark (Benchmark 4) performance of traditional lumber construction with a regular gypsum board ceiling typically found in floors above living spaces.

- The fire containment performance of Assembly 1 was 21 minutes less than the benchmark performance.
- The fire containment performance of Assembly 2 was 35 minutes less than the benchmark performance.
- The fire containment performance of Assembly 3 was 40 minutes less than the benchmark performance.

From the previous AFG sponsored project, it was determined that the fire containment performance (load bearing capacity) of a combustibile floor-ceiling assembly representing typical protected legacy construction (2 x 10) with a ¾ inch metal lath and plaster ceiling was 80 minutes. The time duration was based upon the performance of the assembly when exposed to the time-temperature curve defined in Standard ASTM E119. This was defined as the benchmark (Benchmark 5) performance of traditional lumber construction with a metal lath and plaster ceiling typically found in floors above living spaces.

- The fire containment performance of Assembly 1 was 56 minutes less than the benchmark performance.
- The fire containment performance of Assembly 2 was 70 minutes less than the benchmark performance.
- The fire containment performance of Assembly 3 was 75 minutes less than the benchmark performance.

TABLE OF CONTENTS

CHICAGO FIRE DEPARTMENT, CITY OF CHICAGO..... 1

EXECUTIVE SUMMARY 2

 INTRODUCTION 2

 TEST PLAN..... 3

 TEST RESULTS 5

 RESEARCH FINDINGS 7

LIST OF FIGURES..... 11

LIST OF TABLES..... 13

GENERAL..... 14

 TEST ASSEMBLY MATERIALS..... 14

Material..... 14

Assembly Number..... 14

 FIRE ENDURANCE TEST 15

Test Assemblies, Structural Load, and Instrumentation 15

 PRE-TEST MEASUREMENTS 16

 TEST METHOD 16

 FIRE PERFORMANCE CRITERIA..... 16

 TEST RECORD NO. 1 17

Materials..... 17

Erection of Test Assembly..... 18

Sample..... 19

Method 20

Results..... 21

 TEST RECORD NO. 2 33

Materials..... 33

Erection of Test Assembly..... 33

Sample..... 34

Method 34

Results..... 35

 TEST RECORD NO. 3: 45

Materials..... 45

Erection of Test Assembly..... 46

Sample..... 50

Method 50

Results..... 51

 DISCUSSION 62

Furnace Conditions 62

Structural Serviceability 65

 SUMMARY OF FINDINGS 67

 APPENDIX A – LOCATION OF INSTRUMENTATION..... 69

General 69

Assembly No. 1: 70

Assembly No. 2..... 80
Assembly No. 3..... 87

List of Figures

Figure 1 - UL263 (E119) Standard Time Temperature Curve and Average Furnace Temperature vs. Time for Assembly No. 1.....	21
Figure 2 - Furnace Pressure vs. Time for Assembly No. 1.....	22
Figure 3 - Oxygen Content vs. Time for Assembly No. 1.....	22
Figure 4 - Plot of Temperature of the Average and Maximum Individual Side Of Wood Trusses vs. Time for Assembly No. 1.....	24
Figure 5 - Plot of Temperature of the Mid Depth Between Wood Trusses vs. Time for Assembly No. 1.....	25
Figure 6 - Plot of Temperature of the Sub Floor Between Wood Trusses vs. Time for Assembly No. 1.....	25
Figure 7 - Plot of Temperature of the Bottom Metal Gusset Plates vs. Time for Assembly No. 1.....	26
Figure 8 - Plot of Temperature of the Top Metal Gusset Plates vs. Time for Assembly No. 1.....	26
Figure 9 - Plot of Temperature of the Unexposed Surface of Gypsum Board vs. Time for Assembly No. 1.....	27
Figure 10 - Plot of Temperature of the Top of Subfloor vs. Time for Assembly No. 1 ...	27
Figure 11 - Plot of Temperature of the Carpet Padding vs. Time for Assembly No. 1	28
Figure 12 - Plot of Temperatures of the Unexposed Surface vs. Time for Assembly No. 1	28
Figure 13 - Plot of Temperatures over the Can Lights vs. Time for Assembly No. 1.....	29
Figure 14 - Plot of Temperatures over the Flexible Duct at Junction vs. Time for Assembly No. 1.....	29
Figure 15 - Plot of Temperatures over the Flexible Duct at Center Span vs. Time for Assembly No. 1.....	30
Figure 16 - Plot of Temperatures over the Rigid Duct vs. Time for Assembly No. 1.....	30
Figure 17 - Plot of Temperatures of the Truss Splice Behind Connection of Metal Gussets vs. Time for Assembly No. 1.....	31
Figure 18 - Plot of Temperatures of the Truss Splice 2 in. from Metal Gussets vs. Time for Assembly No. 1.....	32
Figure 19 - Plot of Deflections vs. Time for Assembly No. 1.....	32
Figure 20 - UL263 (ASTM E119) Standard Time Temperature Curve and Average Furnace Temperature vs. Time for Assembly No. 2.....	35
Figure 21 - Furnace Pressure vs. Time for Assembly No. 2.....	36
Figure 22 - Oxygen Content vs. Time for Assembly No. 2.....	36
Figure 23 - Plot of Temperatures of Bottom of Wood Trusses vs. Time for Assembly No. 2.....	38
Figure 24 - Plot of Temperatures of Mid Depth on Side of Wood Trusses vs. Time for Assembly No. 2.....	39
Figure 25 - Plot of Temperatures of Mid Depth Between Wood Trusses vs. Time for Assembly No. 2.....	40
Figure 26 - Plot of Temperatures of Below Subfloor vs. Time for Assembly No. 2.....	40
Figure 27 - Plot of Temperatures of Top Glued Finger Joints vs. Time for Assembly No. 2.....	41

Figure 28 - Plot of Temperatures of Bottom Glued Finger Joints vs. Time for Assembly No. 2..... 41

Figure 29 - Plot of Temperatures of Top of Subfloor vs. Time for Assembly No. 2 42

Figure 30 - Plot of Temperatures of Carpet Padding vs. Time for Assembly No. 2 43

Figure 31 - Plot of Temperatures of Unexposed Surface vs. Time for Assembly No. 2.. 43

Figure 32 - Plot of Deflections vs. Time for Assembly No. 2 44

Figure 33 – UL263 (ASTM E119) Standard Time Temperature Curve and Average Furnace Temperature vs. Time for Assembly No. 3..... 51

Figure 34 – Furnace Pressure vs. Time for Assembly No. 3 51

Figure 35 – Oxygen Content vs. Time for Assembly No. 3 52

Figure 36 – Plot of Temperatures of Bottom of Wood Trusses vs. Time for Assembly No. 3..... 54

Figure 37 – Plot of Temperatures of Side of Wood Trusses vs. Time for Assembly No. 3 55

Figure 38 – Plot of Temperatures of Side of Wood Trusses vs. Time for Assembly No. 3 56

Figure 39 – Plot of Temperatures of the Bottom of the Subfloor between Wood Trusses vs. Time for Assembly No. 3 56

Figure 40 – Plot of Temperatures of the Top Metal Gusset Plates vs. Time for Assembly No. 3..... 57

Figure 41 – Plot of Temperatures of the Bottom Metal Gusset Plates vs. Time for Assembly No. 3..... 57

Figure 42 – Plot of Temperatures of the Top of the Subfloor vs. Time for Assembly No. 3 58

Figure 43 – Plot of Temperature of the Carpet Padding vs. Time 58

Figure 44 – Plot of Temperatures of the Unexposed Surface vs. Time 59

Figure 45 – Plot of Temperatures of the LVL Assembly and Metal Connectors vs. Time 60

Figure 46 – Plot of Deflections vs. Time 61

Figure 47 - Furnace Temperature vs. Time 62

Figure 48 - Percent Oxygen vs. Time 63

List of Tables

Table 1 - Identification of Materials used in Multiple Assemblies	14
Table 2 - Deflection of Assembly After Application of Load	16
Table 3 – Observations for Assembly No. 1	23
Table 4 – Observations for Assembly No. 2	37
Table 5 - Observations for Assembly No. 3	53
Table 6 - Average temperature on exposed surface of sub-floor and average temperature on unexposed surface of floor	64
Table 7 - Summary of Significant Events in Addition to ASTM E119 Conditions of Acceptance	65

General

This section describes the construction of the test assemblies, and the test results.

Test Assembly Materials

Several materials were used to construct more than one test assembly. The assemblies in which these materials were used are identified in Table 1.

Table 1 - Identification of Materials used in Multiple Assemblies

Material	Assembly Number		
	1	2	3
Bearing Plates - 2 by 6	Yes	Yes	Yes
Subflooring (OSB)	Yes	Yes	Yes
Carpet with Padding	Yes	Yes	Yes
Tack Strip	Yes	Yes	Yes
Gypsum Board - 1/2 in.	Yes	No	No

The materials used in more than one assembly are described below.

Bearing Plate (2 by 6) – The nominal 2 in. by 6 in. dimensional lumber measured 1-1/2 in. by 5-1/2 in.

Subflooring (OSB) – Nominal 96 in. by 48 in. by 3/4 in. thick tongue and groove subflooring.

Carpet Padding – The carpet padding measured 5/16 in. thick and was supplied in 6 ft wide by 45 ft long rolls. The carpet padding weighed 0.20 lbs/ft².

Carpet – The carpet was supplied in a 14 ft 2 in. wide by 18 ft. long roll. The nominal thickness of the carpet was 1/2 in. The carpet contained no identification markings. The carpet weighed 0.39 lbs/ft².

Tack Strip – Premium carpet gripper measured 1/4 in. thick by 7/8 in. wide and 48 in. long. The pre-nailed tack lengths were 3/4 in. and were spaced approximately 5-3/4 in. apart along the strip.

Gypsum Board – The nominal 1/2 in. thick regular gypsum wallboard had tapered edges and measured an average of 8 ft long by 4 ft wide and had an average thickness of 1/2 in.

Fire Endurance Test

The fire tests were conducted in accordance with the Standard, Fire Tests of Building Construction and Materials, ASTM E119 (ANSI/UL 263, 13th Edition, April 4, 2003).

Test Assemblies, Structural Load, and Instrumentation

The standard test equipment of (UL) for floor and ceiling assemblies was used for the fire endurance test. The test assemblies were constructed by UL staff at UL's fire test laboratory located in Northbrook, IL.

During preparation of the test frames by UL prior to the construction of the test assembly, 4 in. by 6 in. by 3/4 in. thick steel angles were secured to the East and West edges of the test frames and set at depths of 17 in. for each of the three assemblies. The test frame was protected with vermiculite concrete poured to the top of the angles.

Assemblies 1-3 were loaded with 40 psf applied to the South and West edges of the assembly. The assembly was divided into quarters in the length and width. The loading was positioned over the Western and Southern quarters of the assembly. In addition to the uniform load, two 300 lb mannequins were located 24 inches North and South of the East-West centerline of the assembly, at the center of the span. One mannequin was intended to simulate a standing firefighter and the load was distributed over a four square foot base. The other mannequin was intended to simulate a crawling firefighter and the load was distributed through the hands and knees. Drawings showing the floor assembly loading are located in Appendix A.

The location of instrumentation within the furnace and on the test samples is shown in Appendix A. The furnace chamber temperatures were measured with 16 thermocouples located 12 in. below the exposed surface. A plot of the average furnace temperature verses the standard time temperature curve can be seen under the results portion of each test record.

Pre-Test Measurements

Test Method

All three assemblies were tested in accordance with the fire exposure in ASTM E119 (ANSI/UL 263, 13th Edition, April 4, 2003).

Fire Performance Criteria

The condition of acceptance for these standards state the transmission of heat through the specimen during the classification period shall not have raised the average temperature on its unexposed surface to more than 250°F above its initial temperature or the individual temperature at any point to more than 325°F above its initial temperature. The specimen shall have sustained the applied load during the classification period without developing unexposed surface conditions that will ignite cotton waste.

The deflection of each assembly after application of the load is shown below in Table 2.

Table 2 - Deflection of Assembly After Application of Load

Test Assembly Number	Max. Deflection (Inch)
1	0.17
2	0.05
3	0.06

The floor ceiling assemblies were installed in the test frame in accordance with standard practices and methods. The test assemblies were constructed by UL staff at UL's fire test laboratory located in Northbrook, IL.

Test Record No. 1

Materials

Materials described in section General and used in Assembly No. 1 include 2 by 6 bearing plates, subfloor (OSB), carpet and padding, tack strips, and gypsum board. Additional materials are described below.

Trusses - The parallel chord trusses with trimable ends were 14 in. deep, 13 ft 10 in. long fabricated from nominal 2 in. by 4 in. wood members and had an average weight of 56.01 lb. The nominal 4 in. side of the truss members was oriented in the horizontal direction. The truss members were secured together with galvanized steel plates measuring 0.038 in. thick. The plates contained teeth projecting perpendicular to the plane of the plate. The bottom chord of the trusses were spliced and secured together using a 3 in. by 6 in. steel plates. The splice was located 77 in. from the east edge of the assembly. The moisture content of the truss members ranged from 10.9 to 13.2 percent and averaged 12.09 percent.

Rim Band – The nominal 2 in. by 4 in. dimensional lumber measured 1-1/2 in. by 3-1/2 in.

Strongback – The nominal 2 in. by 6 in. dimensional lumber measured 1-1/2 in. by 5-1/2 in.

Blocking – Nominal 2 in. by 2 in. dimensional lumber was used to mount the diffuser.

Can Light Fixture – The steel can light base measured 9-3/4 in. by 7-1/2 in. and 6-1/2 in. deep with an aperture opening of 6-1/2 in. in diameter. The can light fixtures contained two steel mounting brackets which could be extended to 23-3/4 in.

Can Light Fixture Insert – The plastic and steel fixture insert measured 4-3/8 in. in diameter at the top and 6-1/8 in. at the opening. The steel plate at the bottom of the insert measured 7-1/8 in. in diameter. The insert had an overall depth of 2-3/4 in. as was attached to the can light fixture using two metal springs.

Rigid Duct Reducer – The metal rigid duct reducer measured 10 in. in diameter at the bottom, 6 in. in diameter at the top and had an overall height of 8 in.

Diffuser – The metal diffuser measured 5-3/8 in. wide by 11-3/8 in. long with vents centered and measuring 3-3/4 in wide by 9-1/2 in. long. The diffuser was secured to the 2 in. by 2 in. blocking using two 2 in. long hex-head screws.

Rigid Duct – The metal rigid duct measured 10 in. in diameter and 14 ft 7 in. long.

Flexible Duct – The UL Listed Class 1 Flexible Air Duct measured 6 in. in diameter.

Register Air Supply Duct Sleeve – The metal sleeve measured 6 in. in diameter at the top and reduced to a 4 in. by 10 in. rectangular opening.

Erection of Test Assembly

Nominal 2 in. by 6 in. structural grade wood bearing plates were placed on top of the steel angles. The trusses were placed on the wood bearing plates and spaced 24 in. OC starting at the East West centerline of the assembly. At the North and South ends of the assembly, additional trusses, not in the field of the fire test, were placed over the vermiculite concrete in order stabilize the plywood subfloor. The trusses were fastened to each bearing plate with two No. 16d nails.

Nominal 2 in. by 6 in. structural grade strongbacks were run perpendicular to the vertical member of the trusses located 5 ft 7-7/8 in. from the West side of the assembly. The strongback was secured to the vertical wood members of the trusses with two No. 16d nails at each strongback / truss interface.

Along the east and west edges of the test assembly, nominal 2 in. by 4 in. wood headers (rim band) were placed perpendicular to the trusses and fastened to the top chord of each truss with two No. 16d nails.

A 1/4 in. wide bead of adhesive was placed on the top chord of the trusses. The plywood subfloor was placed on the trusses with the 8 ft long edges positioned perpendicular to the trusses and the ends butted and centered over trusses, with adjacent end joints staggered 4 ft. A 1/8 in. wide bead of adhesive was placed on the tip of the tongue and groove ends of the subfloor before sliding the panels together. The plywood was secured to the trusses with 1-7/8 in. long ringshank underlayment nails spaced 6 in. OC at the perimeter and 12 in. OC in the field with nails 1 in. from the edge of each panel.

The pre-nailed tack strips were secured to the subfloor around the perimeter of the assembly approximately 2 in. from the inside edge of the test frame.

The 6 ft wide carpet padding had joints spaced 6 ft, 12 ft and 17 ft 2 in. starting at the South edge of the assembly. The carpet padding was secured to the subfloor with 1/4 in. long staples spaced 18 in. OC around the perimeter of each laid piece of padding.

The 14 ft 2 in. wide by 17 ft 10 in. long roll of carpet was laid on top of the carpet padding. The carpet was stretched tight and secured to the carpet gripper nailing strips located at the perimeter of the entire assembly.

Six can lights were installed in accordance with the manufacturers installation instructions and located 36 in. from the East and West edges of the assembly. Two of the can lights were located 4 in. South of the centerline truss. Two of the can lights were located 10-1/4 in. South of the third truss on the North side of the assembly. The last two can lights were located 10-1/4 in. North of the third truss on the South side of the assembly.

The 10 in. diameter rigid duct was capped on both ends. The South end of the duct was wrapped with a 12 in. diameter piece of ceramic fiber blanket and butted tight against the South test frame wall. The duct was installed in the boxed portion of the truss located 6 in. East of the North/South centerline. The rigid duct was supported using three galvanized steel straps located approximately 6 ft on center and were secured to the top chord of the trusses with one 8d nail at each end. The rigid duct was suspended 3/4 in. above the bottom chords of the trusses. The joints connecting the rigid duct sections to the duct tees were secured with six 1/2 in. wafer head screws. All joints were taped with aluminum tape.

The large end of the rigid duct reducer was attached to the 10 in. diameter rigid duct tee with six 1/2 in. wafer head screws and UL Listed aluminum tape.

The 48 in. and 36 in. long sections of flexible duct were loose laid in the joist cavities. One end was attached to the rigid duct reducer and the other end was secured to the register air supply duct sleeve using UL Listed aluminum tape. The register air supply duct sleeve was secured to 2 in. by 2in. wood blocking. The registers were located approximately 3 ft on either side of the centerline truss. One register was located 48 in. West of the rigid duct and the second register was located 36 in. East of the rigid duct.

The gypsum board was secured to the exposed side of the assembly with 1-5/8 in. long phosphate coated drywall nails spaced 7 in. OC with the first two nails spaced 1 in. and 6-1/2 in. from the edge. The East-West gypsum board joints were staggered 48 in. The North-South gypsum board joints were aligned. The long edges of the boards were oriented perpendicular to the joists. Two layers of dry mix joint compound was used to cover all gypsum board joints and nails heads.

Sample

The fire endurance test was conducted on the assembly described previously in this Report under "Erection Of Test Assembly". Test results relate only to items tested.

Method

The location of instrumentation within the furnace and on the test sample are shown in Appendix A.

The temperatures of the wood trusses were measured with 20 thermocouples numbered 31-40 were located on the bottom of the trusses and thermocouple numbers 41-50 were located on the side of trusses mid depth facing North and stapled to the trusses.

The temperatures within the interstitial space were measured with 26 thermocouples. These thermocouples were numbered 61-70 and located at mid depth. Thermocouple numbers 71-80 were located on the bottom of the subfloor. Thermocouples numbered 81-83 were located on the top metal gusset plates nearest center of assembly facing North. Thermocouples numbered 84-86 were located on the bottom metal gusset plates nearest center of assembly facing North.

The temperatures between the subfloor and carpet padding were measured with 15 thermocouples and numbered 1-15.

The temperatures on top of the carpet padding (between the carpet padding and carpet) were measured with 15 thermocouples and numbered 16-30.

The unexposed surface temperatures were measured with 13 thermocouples and numbered 87-99. Each thermocouple was covered with a 6 by 6 in. dry ceramic fiber pad.

The temperatures on the unexposed side of the gypsum board were measured with 10 thermocouples and numbered 51-60.

The temperatures on top of the can lights were measured with one thermocouple over each of the 6 can lights and numbered 102-107.

The temperatures on top of the flexible ducts right before the junctions of supply register inlets was measured with two thermocouples numbered 108 and 109.

The temperatures on top of the flexible ducts at mid span were measured with two thermocouples numbered 110 and 111.

The temperatures on top of the rigid supply duct were measured with two thermocouples numbered 112 and 113.

The deflection of the assembly was measured with five electronic transducers.

There were a total of ten camera views taken during the fire exposure period. One camera was positioned in the furnace recording the exposed surface of the assembly, four cameras positioned in the interstitial space between the gypsum board and sub floor. Four other cameras recorded separate angles of the unexposed surface of the assembly and one infrared camera recorded the unexposed surface temperatures.

Results

Throughout the test, observations were made of the character of the fire, of the conditions of the exposed and unexposed surfaces, and of other events relative to the fire resistance performance of the assembly.

Character and Distribution of the Furnace Fire - The furnace fire was luminous and well distributed throughout the test. A plot of the furnace temperature can be seen on Figure 1.

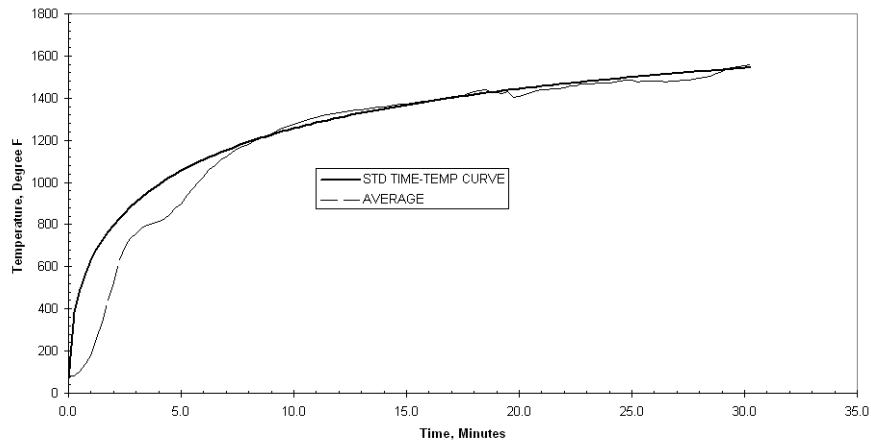

Figure 1 - UL263 (E119) Standard Time Temperature Curve and Average Furnace Temperature vs. Time for Assembly No. 1

The furnace pressure and oxygen concentration during the test are presented in Figure 2 and Figure 3.

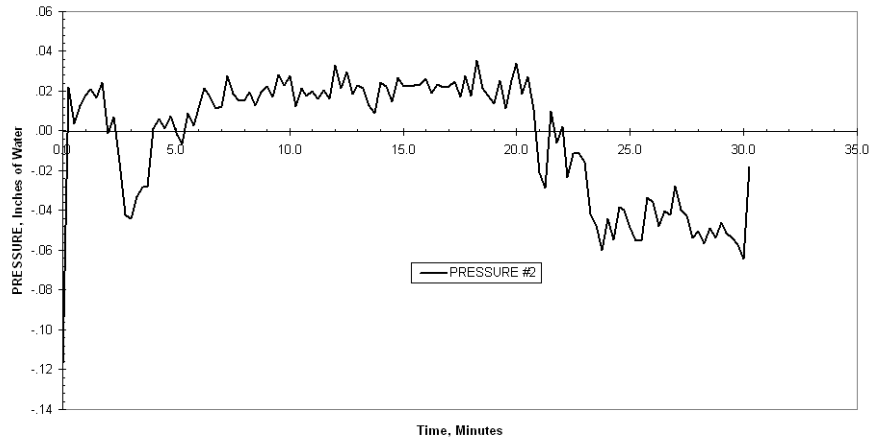

Figure 2 - Furnace Pressure vs. Time for Assembly No. 1

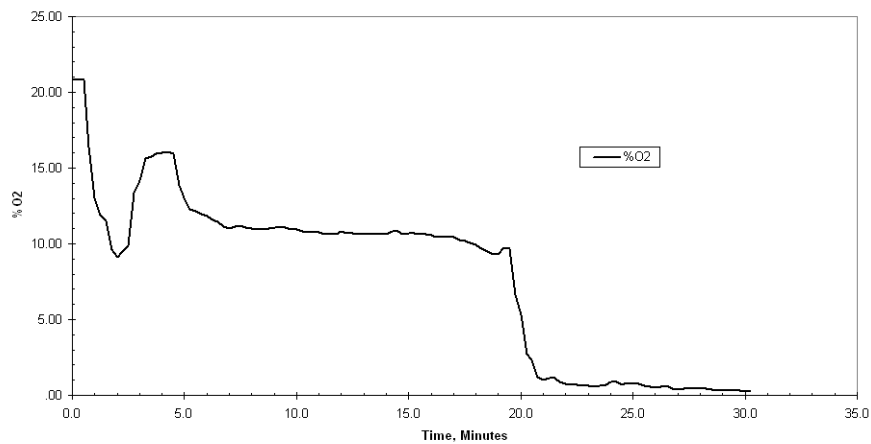

Figure 3 - Oxygen Content vs. Time for Assembly No. 1

Observations of the Exposed and Unexposed Surfaces - The observations made during the fire test are presented in Table 3. All references to dimensions are approximate.

Table 3 – Observations for Assembly No. 1

Test Time, Min:Sec	Exposed (E) or Unexposed (U) Surface	Observations
00:45	E	The paper surface ignited.
01:15	E	The can lights were flaming.
04:00	U	No changes noted.
04:30	E	The paper surface was charred and flaking.
04:45	E	The joint compound began to fall. The trim rings of the can lights were hanging.
05:00	E	The trim rings on the east can lights fell into the furnace chamber.
05:30	E	The registers were becoming deformed.
06:00	U	Smoke issued from the perimeter of the assembly.
07:00	E	The joint compound continued to fall.
09:45	E	The joint compound continued to fall.
10:15	E	Additional trim rings fell into the furnace chamber.
14:00	E	90% of the joint compound had fallen.
15:15	E	Cracks in the gypsum board were noted near the center can lights.
16:00	E	The north-east register fell into the furnace chamber. Cracks in the gypsum board were noted near the south can lights.
17:15	E	Pieces of gypsum boards fell into the furnace chamber.
18:00	U	No changes besides smoke at the perimeter of the assembly.
18:15	E	20 to 25% of the gypsum boards had fallen.
18:45	U	Cracking noises heard.
18:45	E	Cracking noises heard.
19:30	U	Cracking noises continued. Smoke continued.
20:00	E	Visual observations could not be taken due to heavy flaming.
20:15	E	90% of the gypsum boards had fallen.
21:00	U	Very little deflection noted.
22:45	U	Bulges in the carpet noted at the subfloor joints.
24:00	U	Smoke began to emit from the carpet.
25:00	U	Vibration of the firefighters noted.
26:00	U	Flame through on south edge.
27:15	U	Flame through on north edge.
29:00	U	The carpet was buckled over the entire assembly.
29:45	U	A significant drop of the floor was noted.
30:08	E/U	Structural collapse occurred. Furnace fire extinguished.

Temperatures of the Trusses - The finish rating is defined as the time necessary to raise the average temperature measured on the face of the bottom chords nearest the fire 250°F or the time required to raise the temperature on the bottom chords 325°F at any point. The average temperature measured on the bottom chords of the trusses was 78°F before the test. Therefore, the average limiting temperature was 328°F and the individual limiting temperature was 403°F.

The maximum individual limiting temperature for the finish rating was reached at 13 minutes as recorded by thermocouple number 40. A plot of the finish rating temperatures can be seen in Appendix A.

Temperatures at Mid Depth on the Side the Wood Trusses – The average and maximum temperatures of the sides of the wood trusses just before the moment of collapse (30 min 8 sec) were 1446°F and 1490°F respectively. The individual temperature was recorded by thermocouple number 41. A plot of these temperatures can be seen Figure 4.

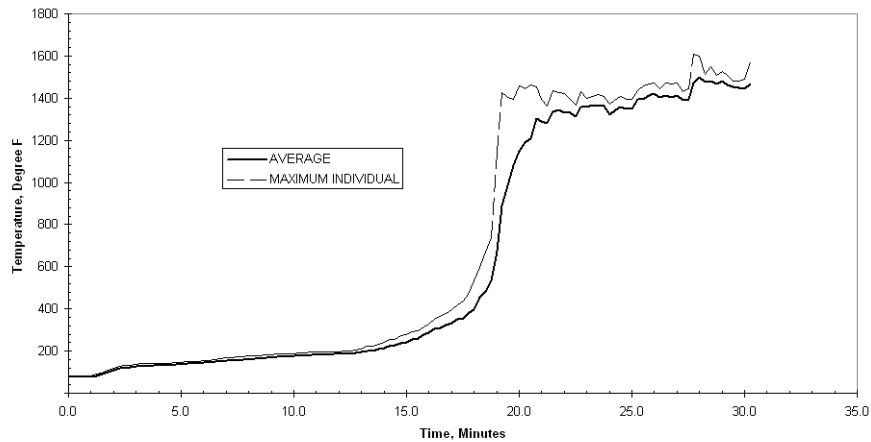

Figure 4 - Plot of Temperature of the Average and Maximum Individual Side Of Wood Trusses vs. Time for Assembly No. 1

Temperatures of the Mid Depth Between Wood Trusses – The average and maximum temperatures of the mid depth between the wood trusses just before the moment of collapse (30 min 8 sec) were 1423°F and 1445°F respectively. The individual temperature was recorded by thermocouple number 64. A plot of these temperatures can be seen on Figure 5.

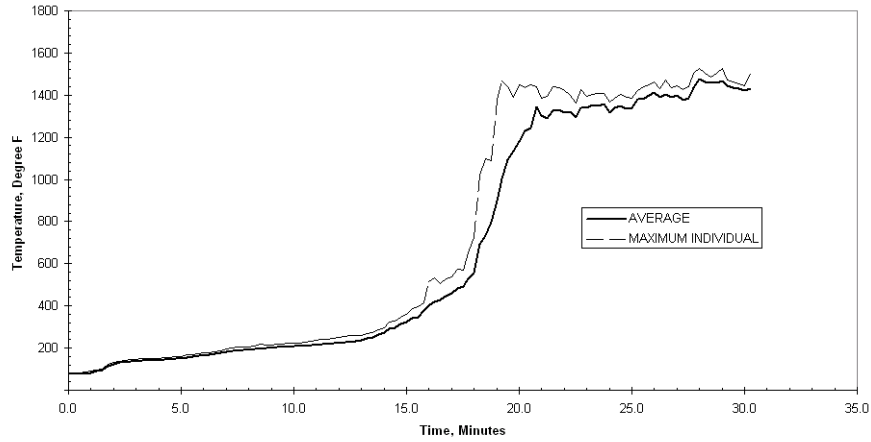

Figure 5 - Plot of Temperature of the Mid Depth Between Wood Trusses vs. Time for Assembly No. 1

Temperatures of the Sub Floor Between Wood Trusses – The average and maximum temperatures of the sub floor between the wood trusses just before the moment of collapse (30 min 8 sec) were 1432°F and 1464°F respectively. The individual temperature was recorded by thermocouple number 74. A plot of these temperatures can be seen on Figure 6.

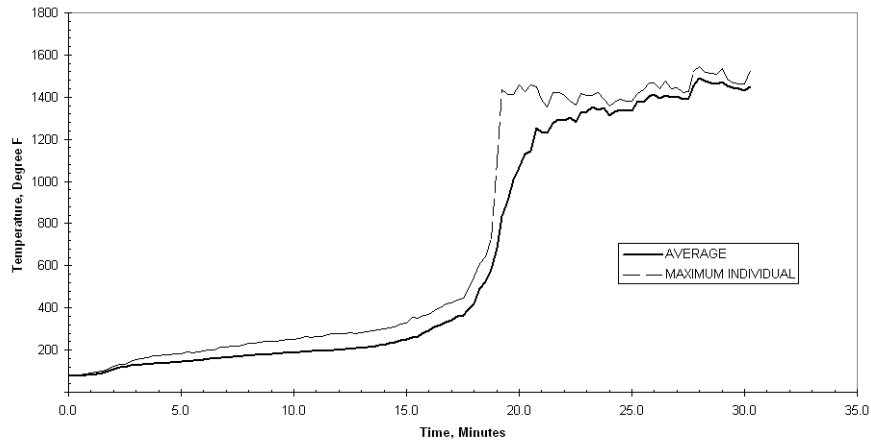

Figure 6 - Plot of Temperature of the Sub Floor Between Wood Trusses vs. Time for Assembly No. 1

Temperatures of the Metal Gusset Plates – The average and maximum temperatures of the bottom metal gusset plates just before the moment of collapse (30 min 8 sec) were 1416°F and 1434°F respectively. The individual temperature was recorded by thermocouple number 83. The average and maximum temperatures of the top metal gusset plates just before the moment of collapse (30 min 8 sec) were 1434°F and 1459°F respectively. The individual temperature was recorded by thermocouple number 86. A plot of the metal gusset temperatures can be seen on Figure 7 and 8 respectively.

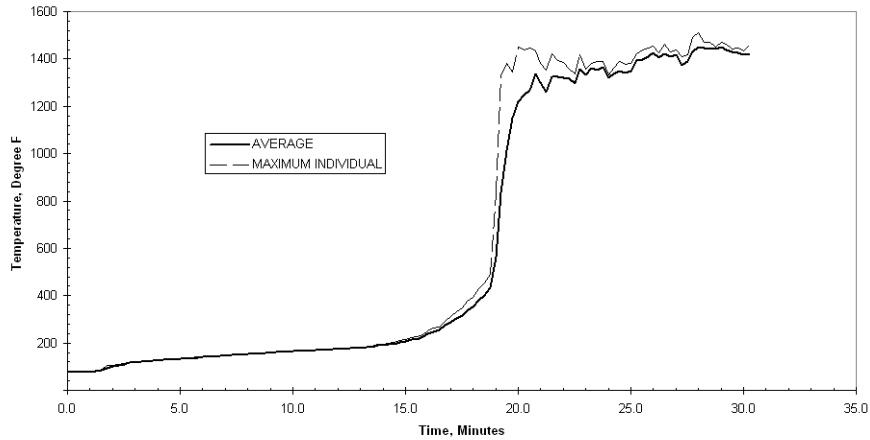

Figure 7 - Plot of Temperature of the Bottom Metal Gusset Plates vs. Time for Assembly No. 1

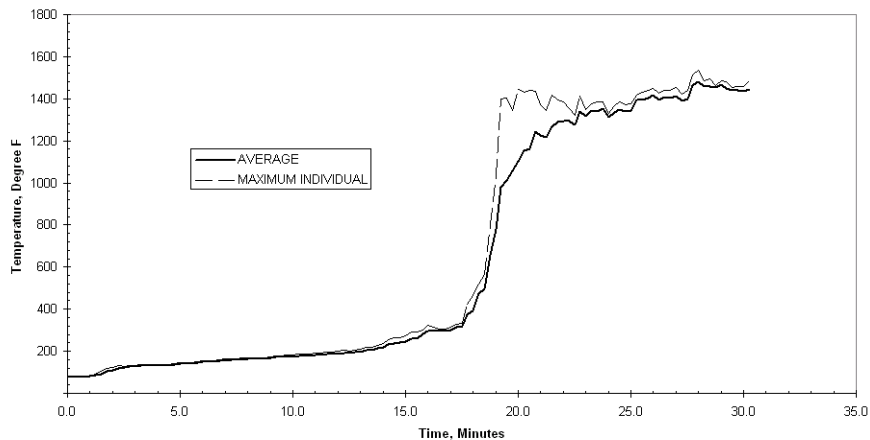

Figure 8 - Plot of Temperature of the Top Metal Gusset Plates vs. Time for Assembly No. 1

Temperatures of the Unexposed Side of Gypsum Board – The average and maximum temperatures of the unexposed surface just before the gypsum board fall off (17 min 15 sec) were 646°F and 965°F respectively. The individual temperature was recorded by thermocouple number 59. A plot of these temperatures can be seen on Figure 9.

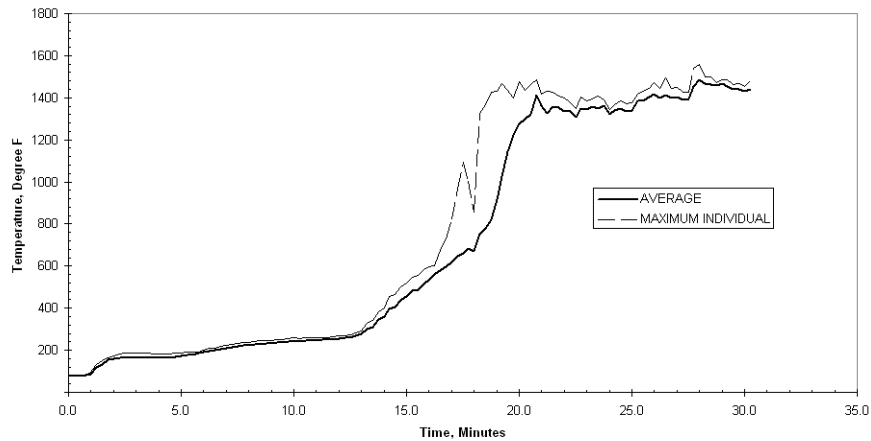

Figure 9 - Plot of Temperature of the Unexposed Surface of Gypsum Board vs. Time for Assembly No. 1

Temperatures Between the Sub Floor and Carpet Padding – The average and maximum temperatures between the sub floor and carpet padding just before the moment of collapse (30 min 8 sec) were 383°F and 704°F respectively. The individual temperature was recorded by thermocouple number 14. A plot of these temperatures can be seen on Figure 10.

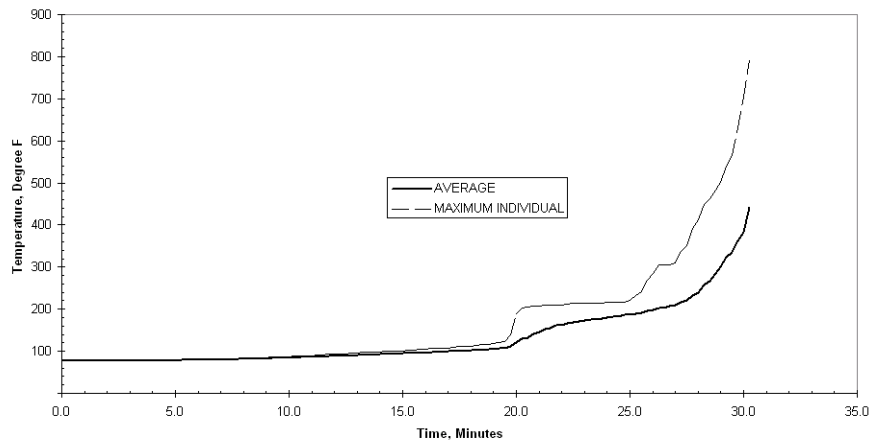

Figure 10 - Plot of Temperature of the Top of Subfloor vs. Time for Assembly No. 1

Temperatures Between the Carpet Padding and Carpet – The average and maximum temperatures between the sub floor and finish floor just before the moment of collapse (30 min 8 sec) were 181°F and 221°F respectively. The individual temperature was recorded by thermocouple number 27. A plot of these temperatures can be seen on Figure 11.

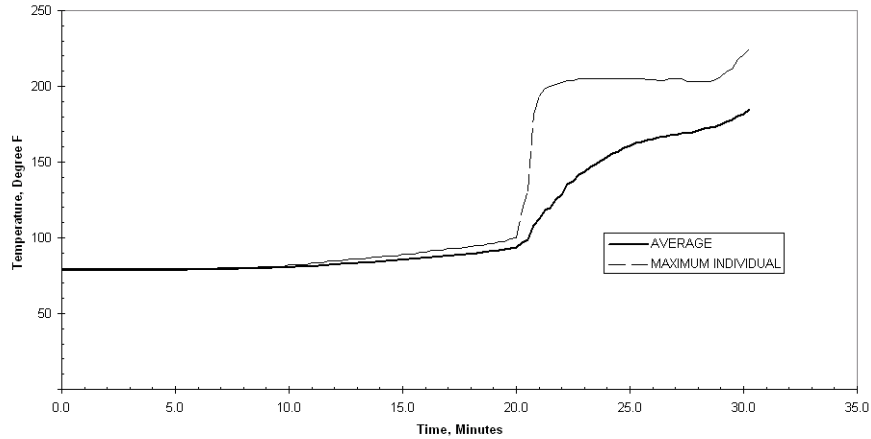

Figure 11 - Plot of Temperature of the Carpet Padding vs. Time for Assembly No. 1

Temperatures of the Unexposed Surface – The average and maximum temperatures of the unexposed surface just before the moment of collapse (30 min 8 sec) were 172°F and 196°F respectively. The individual temperature was recorded by thermocouple number 92. A plot of these temperatures can be seen on Figure 12.

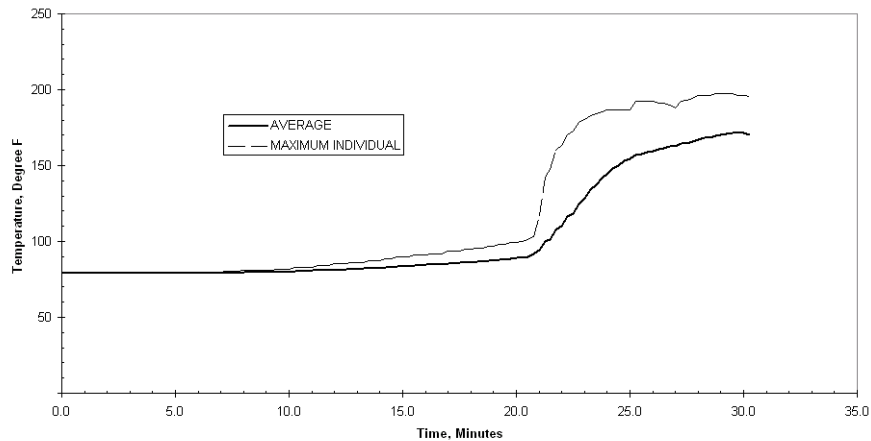

Figure 12 - Plot of Temperatures of the Unexposed Surface vs. Time for Assembly No. 1

Temperatures over the Can Lights – The average and maximum temperatures over the can lights just before the moment of collapse (30 min 8 sec) were 1437°F and 1508°F respectively. The individual temperature was recorded by thermocouple number 102. A plot of these temperatures can be seen on Figure 13.

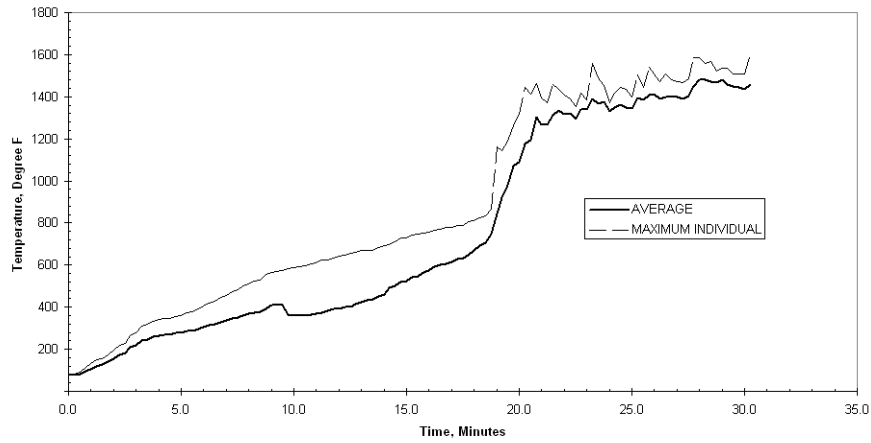

Figure 13 - Plot of Temperatures over the Can Lights vs. Time for Assembly No. 1

Temperatures over the Flexible Duct at Junction – The average and maximum temperatures over the flexible duct at junction just before the moment of collapse (30 min 8 sec) were 1431°F and 1467°F respectively. The individual temperature was recorded by thermocouple number 108. A plot of these temperatures can be seen on Figure 14.

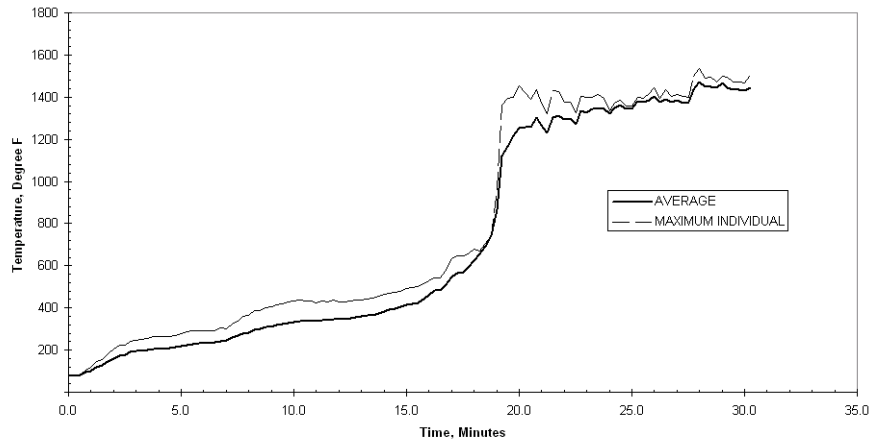

Figure 14 - Plot of Temperatures over the Flexible Duct at Junction vs. Time for Assembly No. 1

Temperatures over the Flexible Duct at Center Span – The average and maximum temperatures over the flexible duct at center span just before the moment of collapse (30 min 8 sec) were 1445°F and 1508°F respectively. The individual temperature was recorded by thermocouple number 110. A plot of these temperatures can be seen on Figure 15.

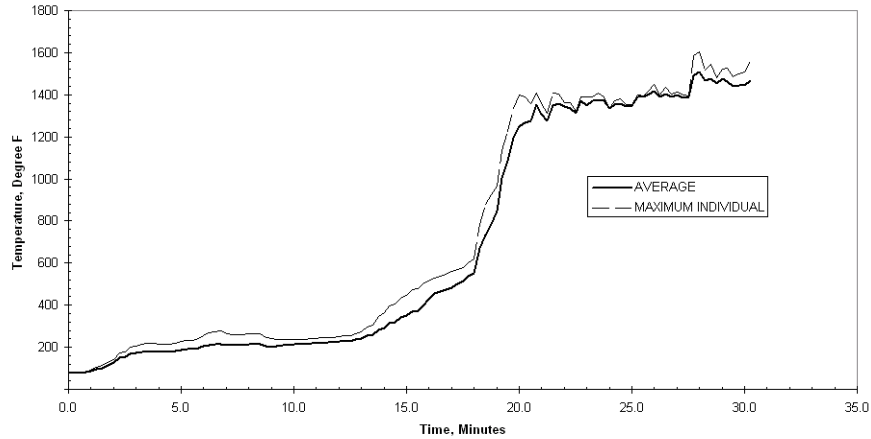

Figure 15 - Plot of Temperatures over the Flexible Duct at Center Span vs. Time for Assembly No. 1

Temperatures over the Rigid Duct – The average and maximum temperatures over the rigid duct just before the moment of collapse (30 min 8 sec) were 1417°F and 1418°F respectively. The individual temperature was recorded by thermocouple number 112. A plot of these temperatures can be seen on Figure 16.

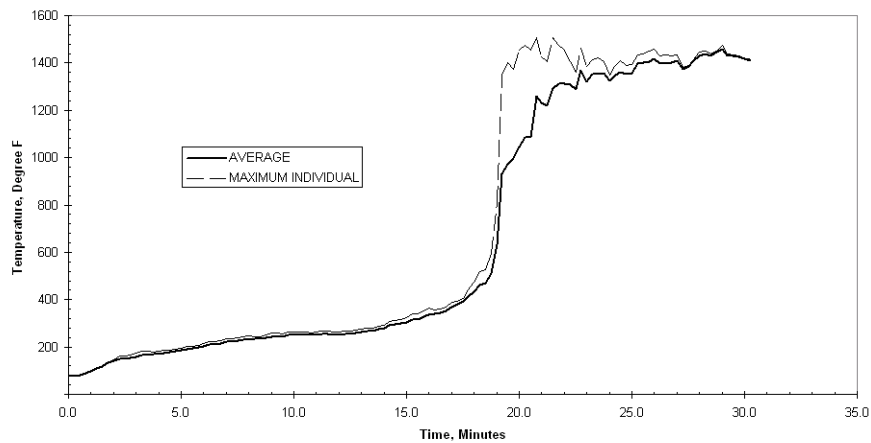

Figure 16 - Plot of Temperatures over the Rigid Duct vs. Time for Assembly No. 1

Temperatures of the Truss Splice Behind Connection of Metal Gussets – The average and maximum temperatures of the truss splice behind connection of metal gussets just before the moment of collapse (30 min 8 sec) were 1463°F and 1495°F respectively. The individual temperature was recorded by thermocouple number 114. A plot of these temperatures can be seen on Figure 17.

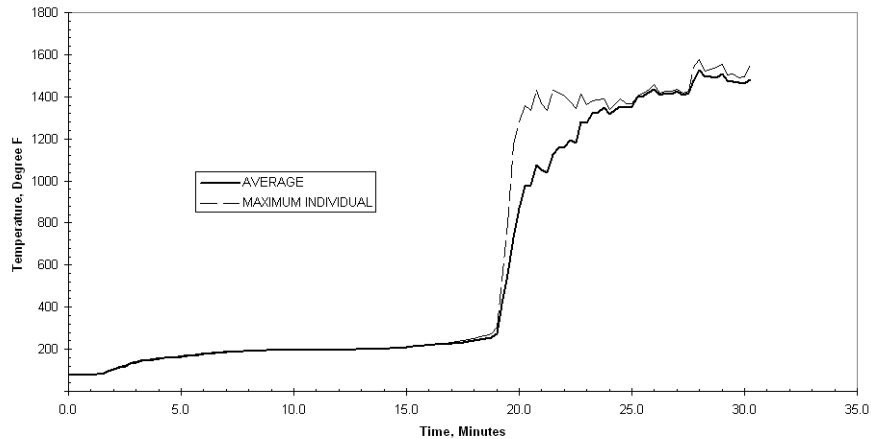

Figure 17 - Plot of Temperatures of the Truss Splice Behind Connection of Metal Gussets vs. Time for Assembly No. 1

Temperatures of the Truss Splice 2 in. from Metal Gussets – The average and maximum temperatures of the truss splice 2 in. from metal gussets just before the moment of collapse (30 min 8 sec) were 1466°F and 1525°F respectively. The individual temperature was recorded by thermocouple number 115. A plot of these temperatures can be seen on Figure 18.

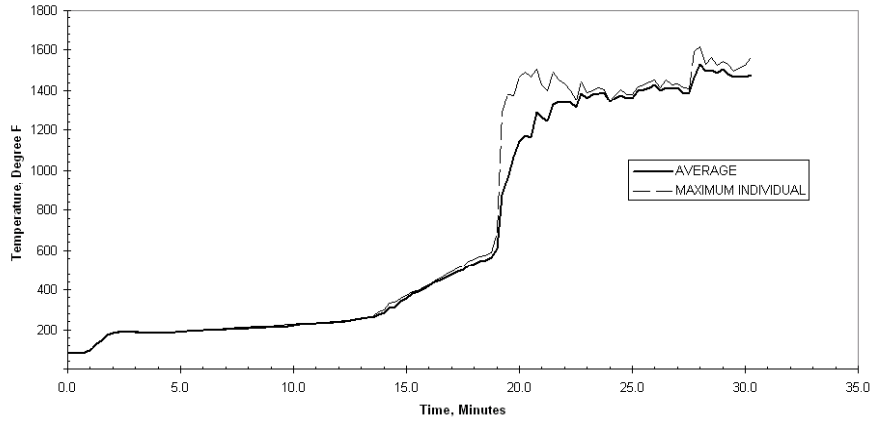

Figure 18 - Plot of Temperatures of the Truss Splice 2 in. from Metal Gussets vs. Time for Assembly No. 1

Deflection of the Assembly - The deflection of the floor-ceiling assembly during the fire test is shown on Figure 19. The location of each deflection transducer can be seen in Appendix A under Test Assembly 1.

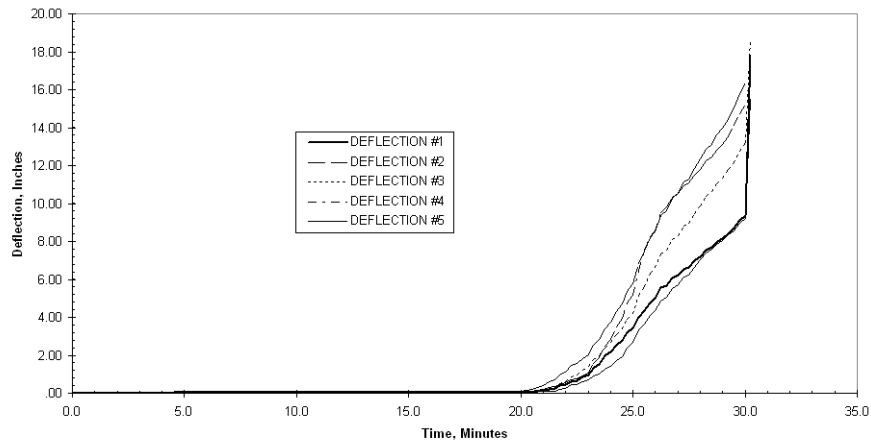

Figure 19 - Plot of Deflections vs. Time for Assembly No. 1

Test Record No. 2

Materials

Materials described in section General and used in Assembly No. 2 include 2 by 6 bearing plates, subfloor (OSB), carpet and padding, and tack strips. Additional materials are described below.

Trusses - The glued finger jointed trusses were nominally 14 in. deep, 14 ft long fabricated from nominal 2 in. by 2 in. wood members with nominal 2 in. 3 in. wide top and bottom chords and had an average weight of 34.11 lb. The top and bottom chords measured 2-1/2 in. wide by 1-1/2 in. high. The web members measured 1-1/2 in. wide by 1-1/2 in. high and the fingers penetrated 3/4 in. into the top and bottom chords. Nominal 2 in. by 6 in. and 2 in. by 8 in. wood members were used as vertical members inside each truss. Two nominal 2 by 8 in. sections of lumber were located at the outer edges of the trusses at the bearing location. Two nominal 2 by 6 in. sections of lumber were located 10-1/4 in. on each side of the truss centerline. The moisture content of the truss members ranged from 11.2 to 13.1 percent and averaged 12.24 percent.

Rim Band – The nominal 2 in. by 4 in. dimensional lumber measured 1-1/2 in. by 3-1/2 in.

Erection of Test Assembly

Nominal 2 in. by 6 in. structural grade wood bearing plates were placed on top of the steel angles. The trusses were placed on the wood bearing plates and spaced 24 in. OC starting at the East West centerline of the assembly. At the North and South ends of the assembly, additional trusses, not in the field of the fire test, were placed over the vermiculite concrete in order stabilize the plywood subfloor. The average bearing at each end of the truss was 5 in. The trusses were fastened to each bearing plate with two No. 16d nails.

Along the east and west edges of the test assembly, nominal 2 in. by 4 in. wood headers (rim band) were placed perpendicular to the trusses and fastened to the top chord of each truss with two No. 16d nails.

A 1/4 in. wide bead of adhesive was placed on the top chord of the trusses. The plywood sub-floor was placed on the trusses with the 8 ft long edges positioned perpendicular to the trusses and the ends butted and centered over trusses, with adjacent end joints staggered 4 ft. A 1/8 in. wide bead of adhesive was placed on the tip of the tongue and groove ends of the subfloor before sliding the panels together. The plywood was secured to the trusses with 1-7/8 in. long ringshank underlayment nails spaced 6 in. OC at the perimeter and 12 in. OC in the field with nails 1 in. from the edge of each panel.

The pre-nailed tack strips were secured to the subfloor around the perimeter of the assembly approximately 2 in. from the inside edge of the test frame.

The 6 ft wide carpet padding had joints spaced 6 ft 12 ft and 17-1/4 ft starting at the South edge of the assembly. The carpet padding was secured to the subfloor with 1/4 in. long staples spaced 18 in. OC around the perimeter of each laid piece of padding.

The 14-1/6 ft wide by 17-5/6 ft long roll of carpet was laid on top of the carpet padding. The carpet was stretched tight and secured to the carpet gripper nailing strips located at the perimeter of the entire assembly.

Sample

The fire endurance test was conducted on the assembly described previously in this Report under "Erection Of Test Assembly". Test results relate only to items tested.

Method

The location of instrumentation within the furnace and on the test sample are shown in Appendix A.

The temperatures of the wood trusses were measured with 20 thermocouples. Thermocouple numbers 31-40 were located on the bottom of the trusses and thermocouple numbers 41-50 were located on the side of trusses mid depth facing North and stapled to the trusses.

The temperatures within the interstitial space were measured with 26 thermocouples. Thermocouple numbers 51-60 were located at mid depth. Thermocouple numbers 61-70 were located on the bottom of the subfloor. Thermocouple numbers 71-73 were located on the bottom glued finger joints nearest center of assembly facing North and thermocouple numbers 74-76 were located on the top glued finger joints nearest center of assembly facing North.

The temperatures between the subfloor and carpet padding were measured with 15 thermocouples and numbered 1-15.

The temperatures on top of the carpet padding (between the carpet padding and carpet) were measured with 15 thermocouples and numbered 16-30.

The unexposed temperatures were measured with 13 thermocouples and numbered 77-89. Each of the unexposed surface thermocouples was covered with a 6 by 6 in. dry ceramic fiber pad.

The deflection of the assembly was measured with five electronic transducers.

There were a total of six camera views taken during the fire exposure period. One camera was positioned in the furnace recording the exposed surface of the assembly. Four other cameras recorded separate angles of the unexposed surface of the assembly and one infrared camera recorded the unexposed surface temperatures.

Results

Throughout the test, observations were made of the character of the fire, of the conditions of the exposed and unexposed surfaces, and of other events relative to the fire resistance performance of the assembly.

Character and Distribution of the Furnace Fire - The furnace fire was luminous and well distributed throughout the test. A plot of the furnace temperature can be seen on Figure 20

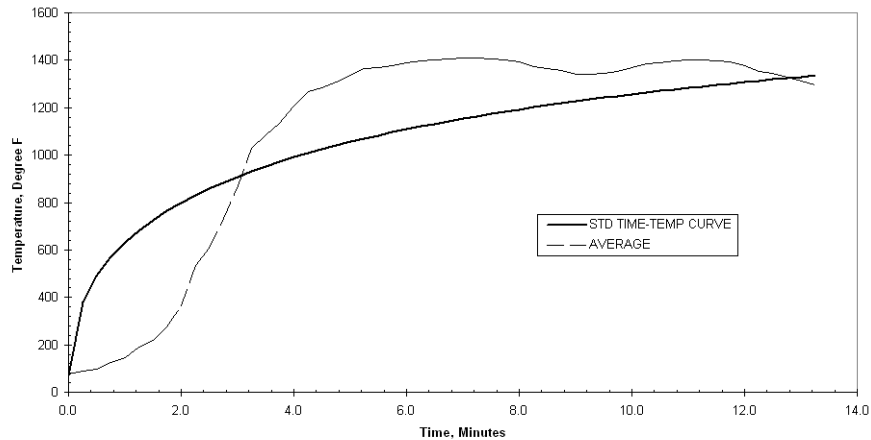

Figure 20 - UL263 (ASTM E119) Standard Time Temperature Curve and Average Furnace Temperature vs. Time for Assembly No. 2

The furnace pressure and oxygen concentration are presented in Figure 21 and Figure 22.

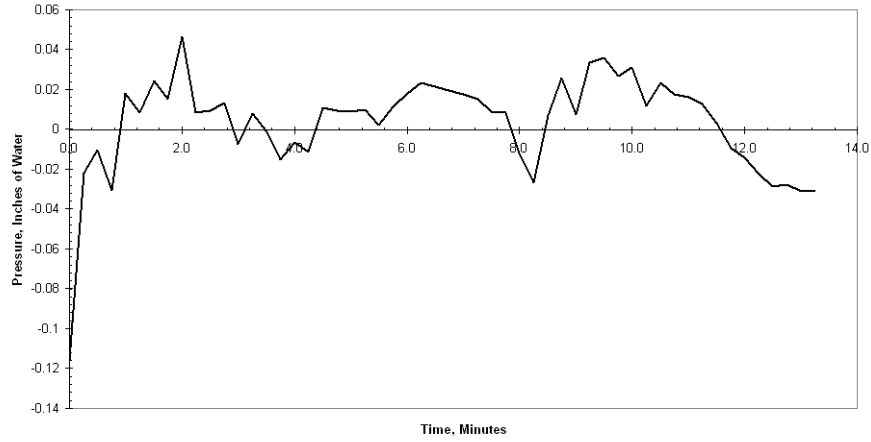

Figure 21 - Furnace Pressure vs. Time for Assembly No. 2

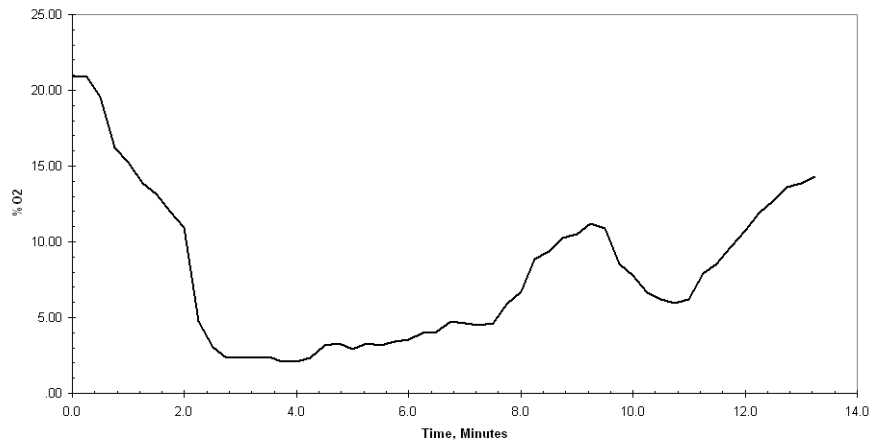

Figure 22 - Oxygen Content vs. Time for Assembly No. 2

Observations of the Exposed and Unexposed Surfaces - The observations made during the fire test are shown in Table 5. All references to dimensions are approximate.

Table 4 – Observations for Assembly No. 2

Test Time, Min:Sec	Exposed (E) or Unexposed (U) Surface	Observations
00:45	U	Smoke issued from the perimeter of the assembly.
00:54	E	The trusses & subfloor ignited.
01:30	U	Smoke continued to issue from the perimeter of the assembly.
01:45	E	Visual observations could not be noted due to the heavy flaming.
02:00	U	Cracking noises heard.
02:30	U	Smoke issued through carpet at subfloor joints.
02:30	E	Cracking noises heard.
03:00	E	Flaming embers were floating in the furnace chamber.
04:00	U	The intensity of the smoke increased.
05:45	U	Char spots noted in the carpet at the subfloor joint locations.
07:00	U	Smoke intensity increased at the subfloor joint locations.
07:30	U	Movement of the firefighters was noted.
08:00	U	Popping noises heard.
08:12	U	The weights at the south end dropped.
08:45	U	Popping noises heard.
08:45	E	Two popping noises were heard.
09:30	E	A popping noise was heard.
09:45	U	Smoke intensity increased. Popping noises heard.
09:45	E	A popping noise was heard.
10:00	E	A popping noise was heard.
10:54	E	An angle member in one of the center trusses was consumed.
11:30	E	The center trusses seem to be in the worst condition.
11:45	U	Flame through on west edge of assembly.
13:06	E/U	Structural collapse occurred. Furnace fire extinguished.

Temperatures of the Trusses - The finish rating is defined as the time necessary to raise the average temperature measured on the face of the bottom chords nearest the fire 250°F or the time required to raise the temperature on the bottom chords 325°F at any point. The average temperature measured on the bottom chords of the trusses was 80°F before the test. Therefore, the average limiting temperature was 330°F and the individual limiting temperature was 405°F.

The maximum individual limiting temperature for the finish rating was reached at 15 seconds as recorded by thermocouple number 36. A plot of the finish rating temperatures can be seen on Figure 23.

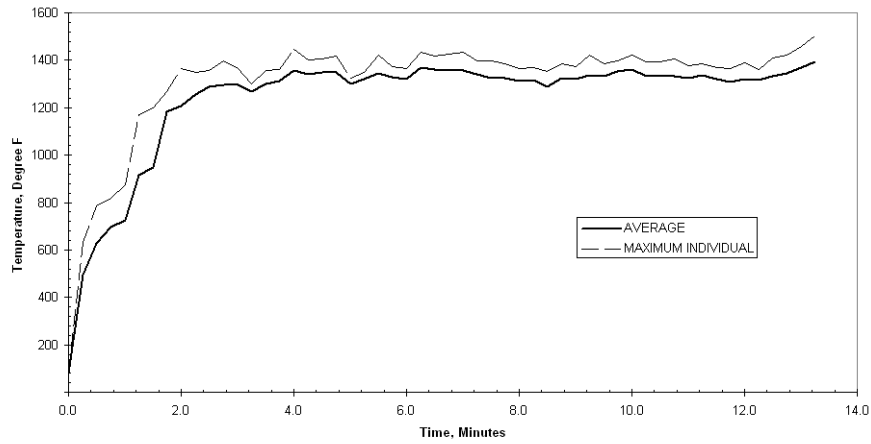

Figure 23 - Plot of Temperatures of Bottom of Wood Trusses vs. Time for Assembly No. 2

Temperatures at Mid Depth on the Side the Wood Trusses – The average and maximum temperatures of the sides of the wood trusses just before the moment of collapse (13 min 6 sec) were 1378°F and 1484°F respectively. The individual temperature was recorded by thermocouple number 43. A plot of these temperatures can be seen on Figure 24.

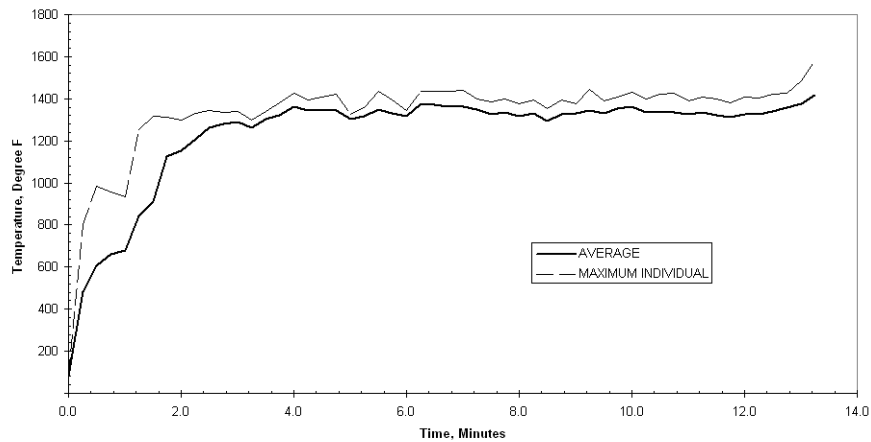

Figure 24 - Plot of Temperatures of Mid Depth on Side of Wood Trusses vs. Time for Assembly No. 2

Temperatures of the Mid Depth Between Wood Trusses – The average and maximum temperatures of the mid depth between the wood trusses just before the moment of collapse (13 min 6 sec) were 1381°F and 1521°F respectively. The individual temperature was recorded by thermocouple number 55. A plot of these temperatures can be seen on Figure 25.

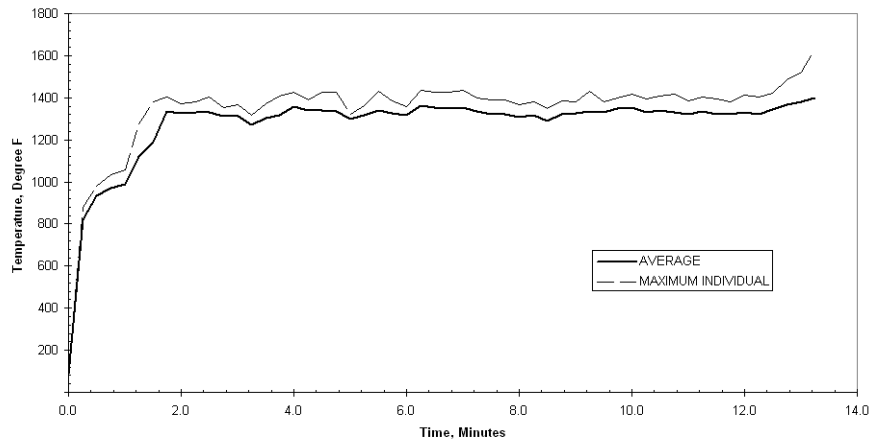

Figure 25 - Plot of Temperatures of Mid Depth Between Wood Trusses vs. Time for Assembly No. 2

Temperatures of the Sub Floor Between Wood Trusses – The average and maximum temperatures of the sub floor between the wood joists just before the moment of collapse (13 min 6 sec) were 1377°F and 1476°F respectively. The individual temperature was recorded by thermocouple number 66. A plot of these temperatures can be seen on Figure 26

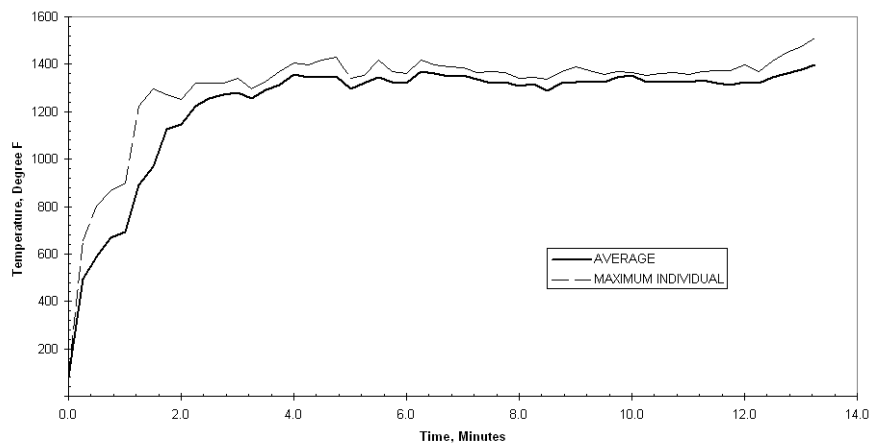

Figure 26 - Plot of Temperatures of Below Subfloor vs. Time for Assembly No. 2

Temperatures of the Glued Finger Joints – The average and maximum temperatures of the top glued finger joints just before the moment of collapse (13 min 6 sec) were 1388°F and 1448°F respectively. The individual temperature was recorded by thermocouple number 74. The average and maximum temperatures of the bottom glued finger joints just before the moment of collapse (13 min 6 sec) were 1378°F and 1439°F respectively. The individual temperature was recorded by thermocouple number 71. A plot of the glued finger joint temperatures can be seen on Figure 27 and Figure 28 respectively.

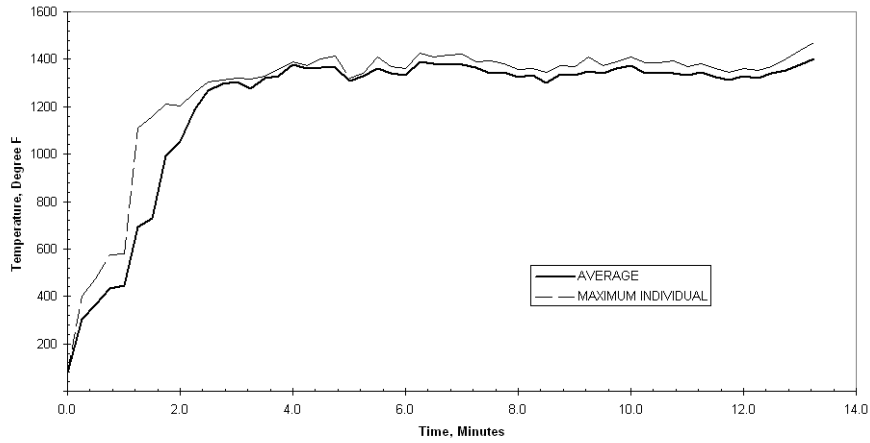

Figure 27 - Plot of Temperatures of Top Glued Finger Joints vs. Time for Assembly No. 2

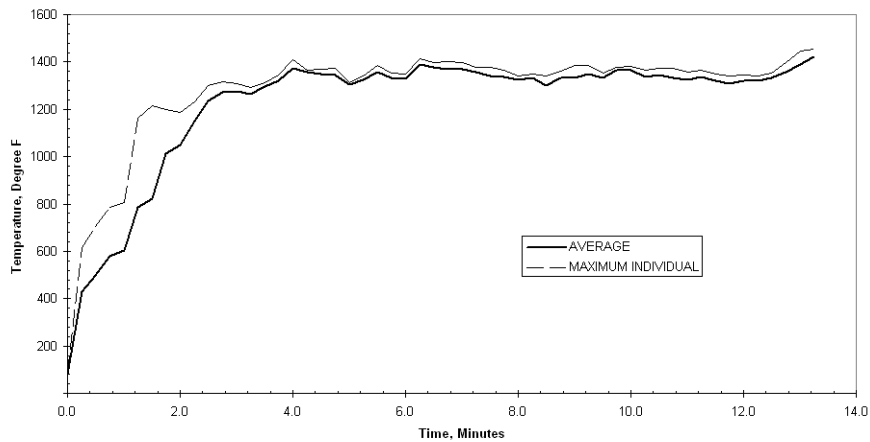

Figure 28 - Plot of Temperatures of Bottom Glued Finger Joints vs. Time for Assembly No. 2

Temperatures Between the Sub Floor and Carpet Padding – The average and maximum temperatures between the sub floor and finish floor just before the moment of collapse (13 min 6 sec) were 701°F and 1353°F respectively. The individual temperature was recorded by thermocouple number 4. A plot of these temperatures can be seen on Figure 29

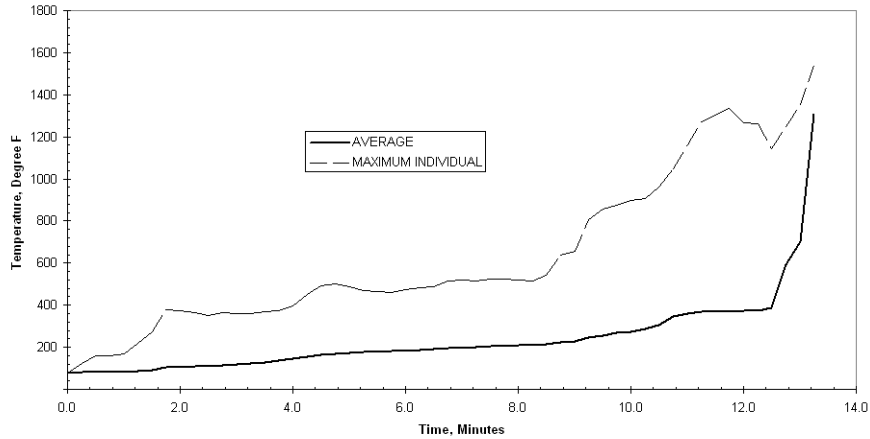

Figure 29 - Plot of Temperatures of Top of Subfloor vs. Time for Assembly No. 2

Temperatures Between the Carpet Padding and Carpet – The average and maximum temperatures between the sub floor and finish floor just before the moment of collapse (13 min 6 sec) were 602°F and 1320°F respectively. The individual temperature was recorded by thermocouple number 24. A plot of these temperatures can be seen on Figure 30.

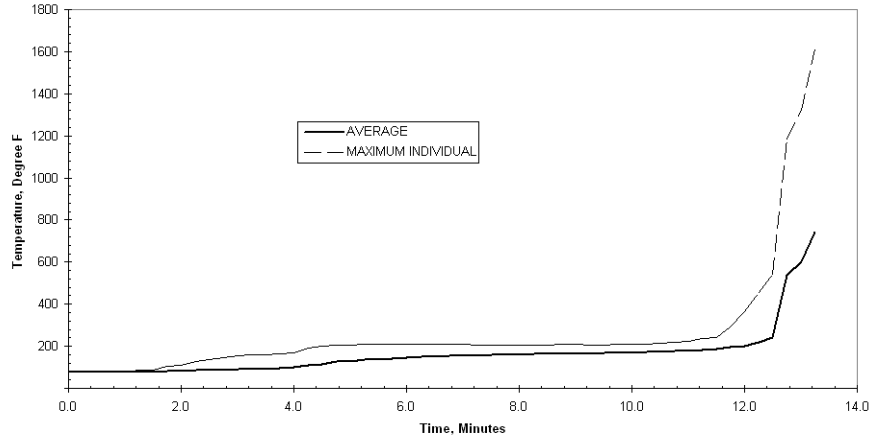

Figure 30 - Plot of Temperatures of Carpet Padding vs. Time for Assembly No. 2

Temperatures of the Unexposed Surface – The average and maximum temperatures of the unexposed surface just before the moment of collapse (13 min 6 sec) were 448°F and 1306°F respectively. The individual temperature was recorded by thermocouple number 82. A plot of these temperatures can be seen on Figure 31.

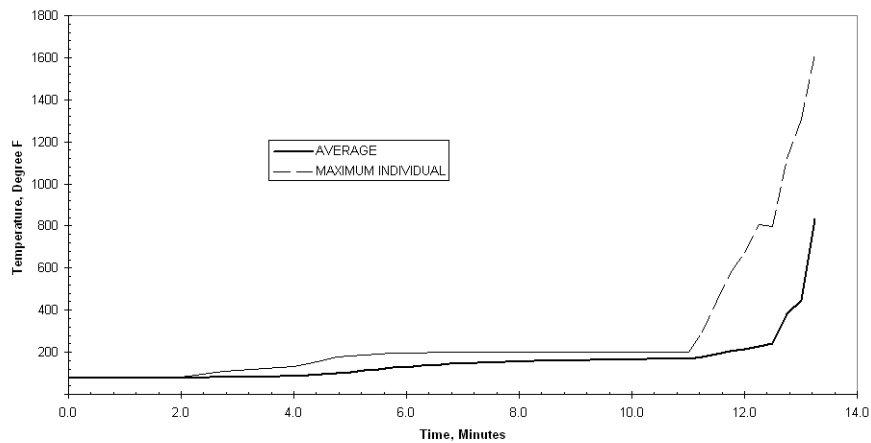

Figure 31 - Plot of Temperatures of Unexposed Surface vs. Time for Assembly No. 2

Deflection of the Assembly - The deflection of the floor-ceiling assembly during the fire test is shown on Figure 32. The location of each deflection transducer can be seen in Appendix A under Test Assembly 2.

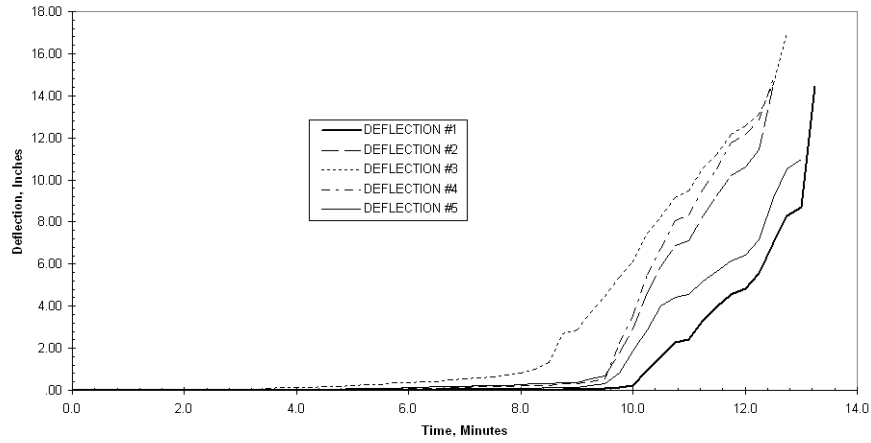

Figure 32 - Plot of Deflections vs. Time for Assembly No. 2

Test Record No. 3:**Materials**

Materials described in Section General and used in Assembly No. 3 include 2 by 6 bearing plates, subfloor (OSB), carpet and padding, and tack strips. Additional materials are described below.

Trusses – There were three different metal gusseted truss configurations used for Assembly 3. The first parallel chord trusses (1F1G Girder Trusses) were 14 in. deep, 13 ft 10 in. long fabricated from nominal 2 in. by 4 in. wood members and had an average weight of 135.05 lbs. The girder trusses were two 1F1G trusses fastened together with steel bands and 6 in. long screws. There was a splice of the bottom chord located 6 ft 5 in. from the east side of the trusses. The second parallel chord trusses (1F1) were 14 in. deep, 13 ft 10 in. long fabricated from nominal 2 in. by 4 in. wood members and had an average weight of 56.58 lbs. There was a splice of the bottom chord located 6 ft 5 in. from the east side of the trusses. The third parallel chord trusses (1F2) were 14 in. deep, 10 ft 10 in. long fabricated from nominal 2 in. by 4 in. wood members and had an average weight of 46.7 lbs. There was a splice of the bottom chord located 3 ft 5 in. from the east side of the trusses. The nominal 4 in. side of the truss members was oriented in the horizontal direction. The truss members were secured together with galvanized steel plates measuring 0.036 in. thick. The plates contained teeth projecting perpendicular to the plane of the plate. The moisture content of the truss members ranged from 12.1 to 20.3 percent and averaged 16.2 percent.

Rim Board – The nominal 2 in. by 4 in. dimensional lumber measured 1-1/2 in. by 3-1/2 in.

Strongback – The nominal 2 in. by 6 in. dimensional lumber measured 1-1/2 in. by 5-1/2 in.

LVL Beam – Each LVL beam measured 12 ft 1/4 in. long by 14 in. tall by 1-3/4 in. thick and weighted 84.5 lbs.

Rim Board – Each rim board measured 12 ft 1/4 in. long by 14 in. tall by 1-1/4 in. thick and weighted 50.8 lbs.

Wood I-Joists – The wood I-joists were provided in 10 ft lengths and were 14 in. deep. The web was composed of particleboard measuring 10-7/8 in. by 3/8 in. and the top and bottom chords were composed of solid lumber measuring 3-1/2 in. by 1-1/2 in. Each joist weighed approximately 41.9 lbs.

MIT Hanger – The connectors measured 3-3/4 in. wide by 14 in. deep and were composed of 0.057 in. thick steel. Each connector weighed approximately 1.4 lbs.

THA Hanger – The connectors measured 3-3/4 in. wide by 14 in. deep and were composed of 0.058 in. thick steel. Each connector weighed approximately 1.3 lbs.

Erection of Test Assembly

See Illustration 1 for detailed layout of Assembly 3.

Nominal 2 in. by 6 in. structural grade wood bearing plates were placed on top of the steel angles. Two 1F1 trusses were located at each North and South edges of the assembly. The outermost North and South trusses were not in the field of the fire test and were placed over the vermiculite concrete in order stabilize the plywood subfloor. The trusses were fastened to each bearing plate with two No. 16d nails.

The 1F1G girder trusses were located 6 ft North and South of the centerline of the assembly. The girder trusses were secured to the 2 in. by 6 in bearing plates with two 16d nails at each end.

Two THA hangers were fastened to the 1F1G Girder trusses 36-1/4 in. from the East edge of the assembly. Both hangers were positioned towards the assembly centerline.

Two LVL beams were secured together with two 3 in. long connector screws spaced 4 in. from the end and 12 in. on center thereafter. The LVL beam was secured to each THA hanger.

Five MIT hangers were secured to the east side of the LVL beam and five THA hangers were secured to the west side of the LVL beam. The hangers were spaced 24 in. OC.

On the West side of the LVL assembly one end of each 1F2 truss was secured to the 2 in. by 6 in. bearing plate with two 16d nails and the other end was secured the THA hangers. The trusses were spaced 24 in. OC.

On the East side of the LVL assembly the wood I joists were secured the 2 in. by 6 in wood bearing plate and the other end was secured to the MIT hangers. The wood I joists were spaced 24 in. OC.

At the North and South ends of the assembly, two 1F1 trusses were installed. One truss was located 24 in. from the girder and the second truss was installed at the edge the test frame. Each end of the trusses were secured to the 2 in. by 6 in bearing plates with two 16d nails at each end.

Nominal 2 in. by 6 in. structural grade strongbacks were run perpendicular to the vertical member of the trusses located 5 ft 7-1/2 in. from the West side of the assembly. The strongback was secured to the vertical wood members of the trusses with two No. 16d nails at each strongback / truss interface.

Along the East and West edges of the test assembly, nominal 2 in. by 4 in. wood headers (rim band) were placed perpendicular to the trusses and fastened to the top chord of each truss with two No. 16d nails.

Along the East edge of the assembly, the rim board was placed perpendicular to the wood I-joists and fastened to the top chord of each wood I joist with two 16d nails.

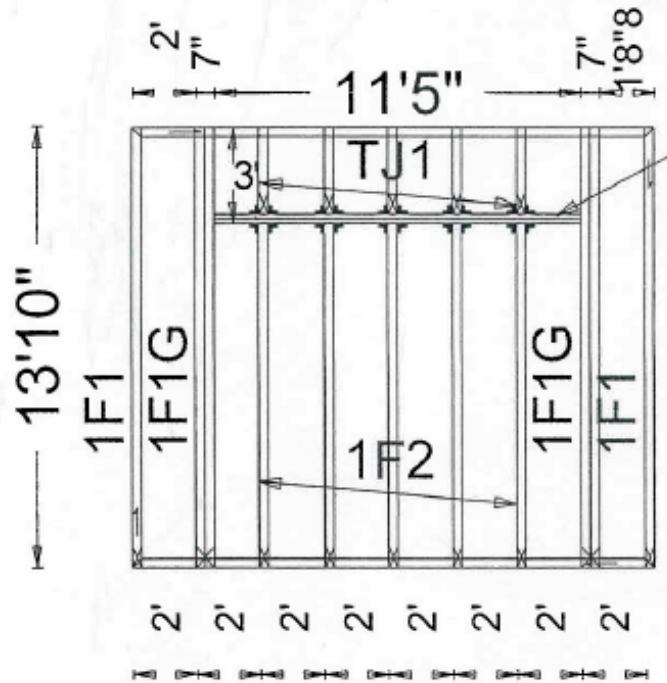

ILL 1 - Layout of Assembly No. 3

A 1/4 in. wide bead of adhesive was placed on the top chord of the trusses. The plywood sub-floor was placed on the trusses with the 8 ft long edges positioned perpendicular to the trusses and the ends butted and centered over trusses, with adjacent end joints staggered 4 ft. A 1/8 in. wide bead of adhesive was placed on the tip of the tongue and groove ends of the subfloor before sliding the panels together. The plywood was secured to the trusses with 1-7/8 in. ringshank underlayment nails spaced 6 in. OC at the perimeter and 12 in. OC in the field with nails 1 in. from the edge of each panel.

The plywood sub-floor was placed and secured on the wood I-joists in the same manner as the trusses. Joints in the OSB subfloor were placed at the center of the truss girders and LVL beam to simulate the discontinuity at a stairwell opening.

The pre-nailed tack strips were secured to the subfloor around the perimeter of the assembly approximately 2 in. from the inside edge of the test frame. No tack strips were placed over the wood I joists.

The 6 ft wide carpet padding had joints spaced 6 ft, 12 ft and 17 ft 2 in. starting at the West edge of the assembly. The carpet padding was secured to the subfloor with 1/4 in. long staples spaced 18 in. OC around the perimeter of each laid piece of padding. No padding was placed over the wood I joists.

The 14 ft 2 in. wide by 17 ft 10 in. long roll of carpet was laid on top of the carpet padding. The carpet was stretched tight and secured to the carpet gripper nailing strips located at the perimeter of the entire assembly. A section measuring 11 ft 5 in by 36-1/4 in. was cut from the carpet as to not cover the wood I-joists.

Sample

The fire endurance test was conducted on the assembly described previously in this Report under "Erection Of Test Assembly". Test results relate only to items tested.

Method

The location of instrumentation within the furnace and on the test sample are shown in Appendix A.

The temperatures of the wood trusses were measured with 20 thermocouples numbered 31-40 were located on the bottom of the trusses and thermocouple numbers 41-50 were located on the side of trusses mid depth facing North and stapled to the trusses.

The temperatures of the wood I joists were measured with 2 thermocouples numbered 92 and 93 and were located on the bottom of the joists.

The temperatures of the LVL assembly were measured with 2 thermocouples numbered 90 and 91 and were located on the bottom of the LVLs.

The temperatures of the metal Connectors were measured with 4 thermocouples numbered 94-97 and were located on the bottom of the metal connectors.

The temperatures within the interstitial space were measured with 26 thermocouples. These thermocouples were numbered 51-60 and located at mid depth. Thermocouple numbers 61-70 were located on the bottom of the subfloor. Thermocouples numbered 74-76 were located on the bottom metal gusset plates nearest center of assembly facing North. Thermocouples numbered 71-73 were located on the top metal gusset plates nearest center of assembly facing North.

The temperatures between the subfloor and carpet padding were measured with 15 thermocouples and numbered 1-15.

The temperatures on top of the carpet padding (between the carpet padding and carpet) were measured with 15 thermocouples and numbered 16-30.

The unexposed surface temperatures were measured with 13 thermocouples and numbered 77-89. Each thermocouple was covered with a 6 by 6 in. dry ceramic fiber pad.

The deflection of the assembly was measured with five electronic transducers.

There were a total of six camera views taken during the fire exposure period. One camera was positioned in the furnace recording the exposed surface of the assembly. Four other cameras recorded separate angles of the unexposed surface of the assembly and one infrared camera recorded the unexposed surface temperatures.

Results

Throughout the test, observations were made of the character of the fire, of the conditions of the exposed and unexposed surfaces, and of other events relative to the fire resistance performance of the assembly.

Character and Distribution of the Furnace Fire - The furnace fire was luminous and well distributed throughout the test. A plot of the furnace temperature can be seen on Figure 33.

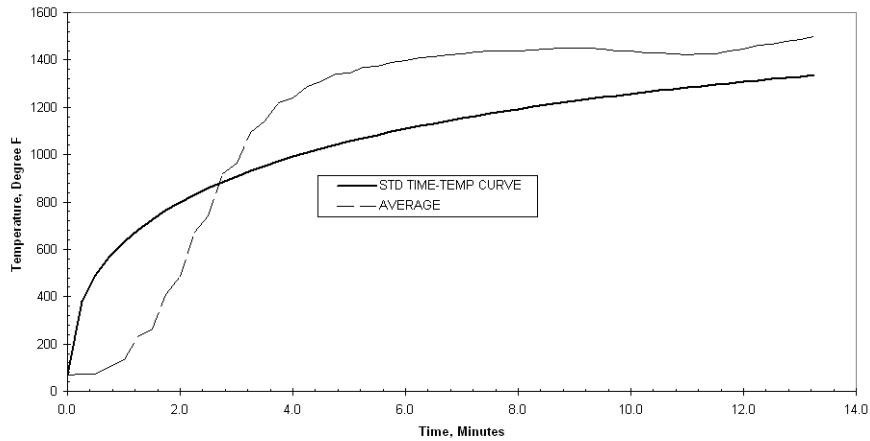

Figure 33 – UL263 (ASTM E119) Standard Time Temperature Curve and Average Furnace Temperature vs. Time for Assembly No. 3

The furnace pressure and oxygen concentration are presented in Figure 34 and Figure 35.

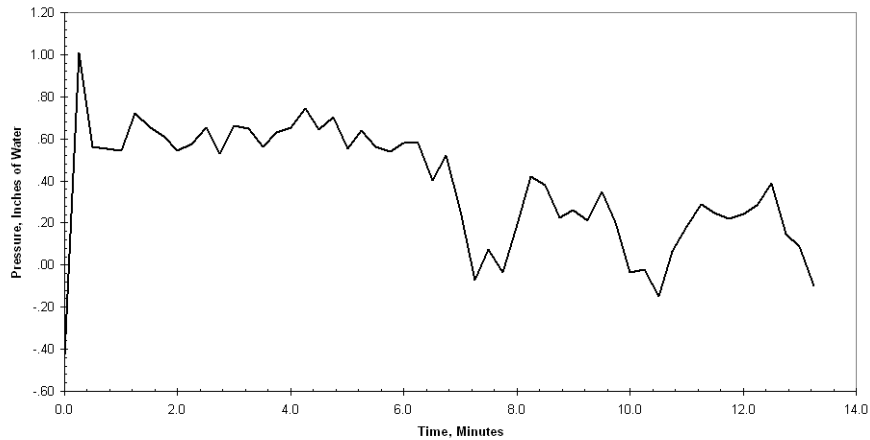

Figure 34 – Furnace Pressure vs. Time for Assembly No. 3

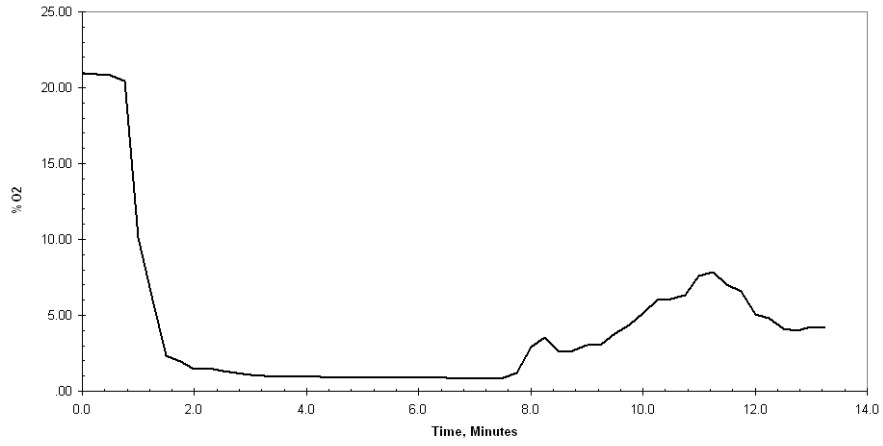

Figure 35 – Oxygen Content vs. Time for Assembly No. 3

Observations of the Exposed and Unexposed Surfaces - The following observations were made during the fire test are show in Table 6. All references to dimensions are approximate.

Table 5 - Observations for Assembly No. 3

<u>Test Time, Min:Sec</u>	<u>Exposed (E) or Unexposed (U) Surface</u>	<u>Observations</u>
00:15	E	Oil and dust on thermocouple wires flashed.
00:30	U	Smoke issued from under the carpet at the interface of the exposed subflooring.
00:30	E	Structural members ignited.
01:00	E	Cracking noises heard.
01:30	U	Smoke issued form the drain holes of the exposed subflooring.
01:30	E	Subflooring ignited.
02:00	U	The carpet was darkening near at the drain holes near the kneeling firefighters hands.
02:00	E	Furnace Chamber filled with heavy smoke.
03:30	U	The intensity of the smoke increased. Cracking noises were heard.
04:00	E	Heavy smoke continued in the furnace chamber.
04:30	U	Burn holes at the subflooring drain holes were increasing in size.
05:15	E	Bottom chords of the trusses were breaking apart and falling into the furnace chamber.
06:00	U	Noticeable deflection was noted at the center of the assembly.
06:00	E	Additional bottom chords falling into the furnace chamber.
07:30	U	The intensity of the smoke increased.
09:00	E	All structural members seem to be disconnected from the LVL.
10:00	U	Burn holes at the subflooring drain holes were increasing in size. The intensity of the smoke increased.
11:00	U	A gap began to develop at the side joint of the subflooring at the interface with the carpet
11:30	E	The LVL seems to have disconnected from the south girder. The south girder seems to be intact.
11:30	U	Flame through at the east subflooring joint.
12:30	U	Flame through at the west subflooring joint.
13:00	E	The north girder was falling apart.
13:20	E/U	Structural collapse occurred. Furnace fire extinguished.

Temperatures of the Trusses - The finish rating is defined as the time necessary to raise the average temperature measured on the face of the bottom chords nearest the fire 250°F or the time required to raise the temperature on the bottom chords 325°F at any point. The average temperature measured on the bottom chords of the trusses was 81°F before the test. Therefore, the average limiting temperature was 331°F and the individual limiting temperature was 406°F.

The maximum individual limiting temperature for the finish rating was reached at 30 seconds as recorded by thermocouple number 37. A plot of the finish rating temperatures can be seen on Figure 36.

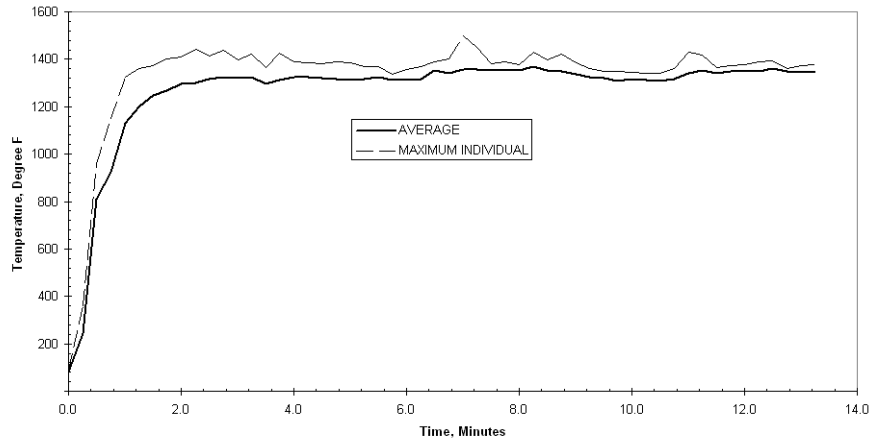

Figure 36 – Plot of Temperatures of Bottom of Wood Trusses vs. Time for Assembly No. 3

Temperatures at Mid Depth on the Side the Wood Trusses – The average and maximum temperatures of the sides of the wood trusses just before the moment of collapse (13 min 20 sec) were 1346°F and 1373°F respectively. The individual temperature was recorded by thermocouple number 46. A plot of these temperatures can be seen on Figure 37.

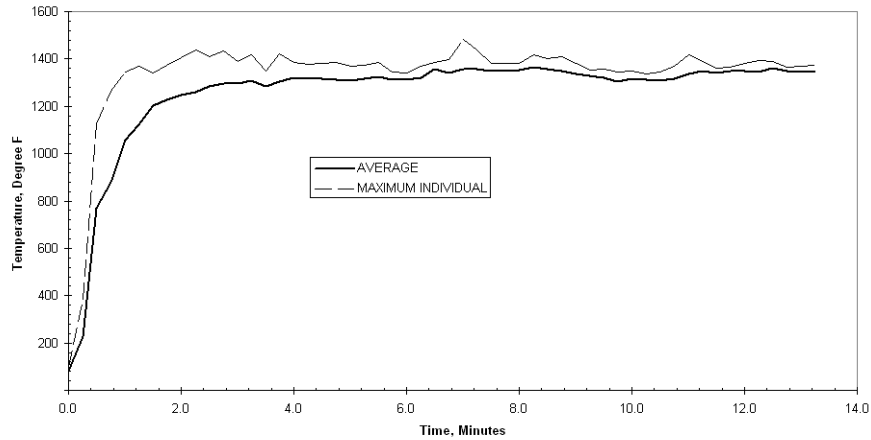

Figure 37 – Plot of Temperatures of Side of Wood Trusses vs. Time for Assembly No. 3

Temperatures of the Mid Depth Between Wood Trusses – The average and maximum temperatures of the mid depth between the wood trusses just before the moment of collapse (13 min 20 sec) were 1346°F and 1375°F respectively. The individual temperature was recorded by thermocouple number 59. A plot of these temperatures can be seen on Figure 38.

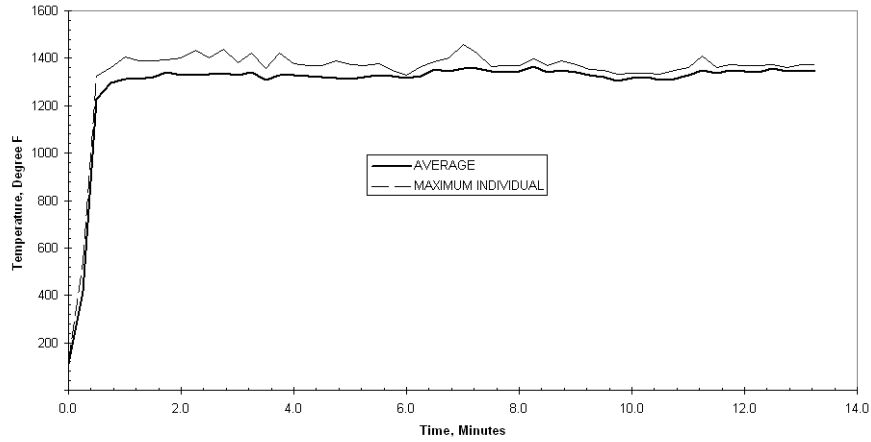

Figure 38 – Plot of Temperatures of Side of Wood Trusses vs. Time for Assembly No. 3

Temperatures of the Bottom of the Sub Floor Between Wood Trusses – The average and maximum temperatures of the sub floor between the wood trusses just before the moment of collapse (13 min 20 sec) were 1350°F and 1372°F respectively. The individual temperature was recorded by thermocouple number 70. A plot of these temperatures can be seen on Figure 39.

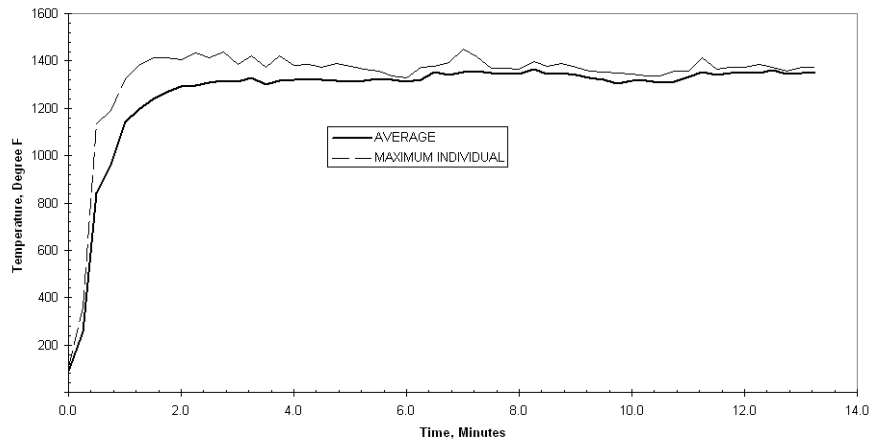

Figure 39 – Plot of Temperatures of the Bottom of the Subfloor between Wood Trusses vs. Time for Assembly No. 3

Temperatures of the Metal Gusset Plates – The average and maximum temperatures of the top metal gusset plates just before the moment of collapse (13 min 20 sec) were 1333°F and 1354°F respectively. The individual temperature was recorded by thermocouple number 73. The average and maximum temperatures of the bottom metal gusset plate just before the moment of collapse (13 min 20sec) were 1338°F and 1347°F respectively. The individual temperature was recorded by thermocouple number 74. A plot of the metal gusset temperatures can be seen on Figure 40 and Figure 41.

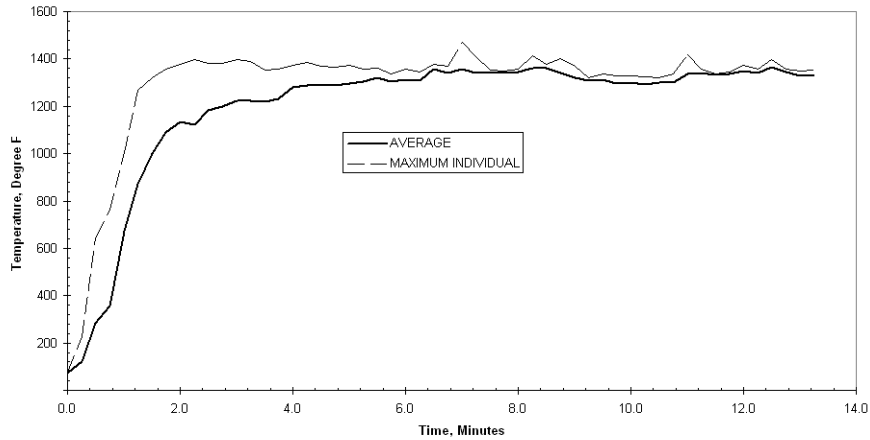

Figure 40 – Plot of Temperatures of the Top Metal Gusset Plates vs. Time for Assembly No. 3

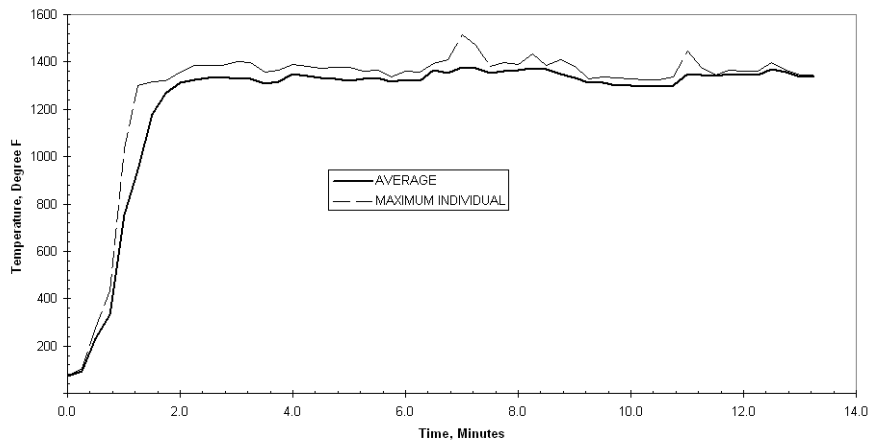

Figure 41 – Plot of Temperatures of the Bottom Metal Gusset Plates vs. Time for Assembly No. 3

Temperatures Between the Sub Floor and Carpet Padding – The average and maximum temperatures between the sub floor and finish floor just before the moment of collapse (13 min 20 sec) were 597°F and 1424°F respectively. The individual temperature was recorded by thermocouple number 4. A plot of these temperatures can be seen on Figure 42.

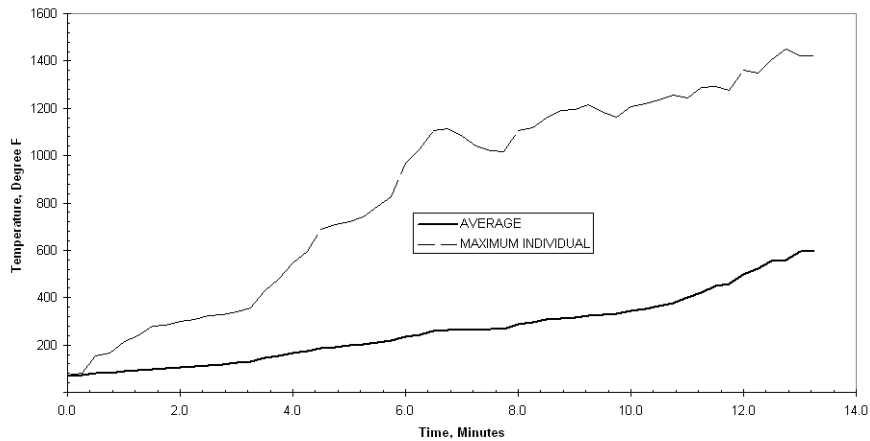

Figure 42 – Plot of Temperatures of the Top of the Subfloor vs. Time for Assembly No. 3

Temperatures Between the Carpet Padding and Carpet – The average and maximum temperatures between the sub floor and finish floor just before the moment of collapse (13 min 20 sec) were 489°F and 1397°F respectively. The individual temperature was recorded by thermocouple number 24. A plot of these temperatures can be seen on Figure 43.

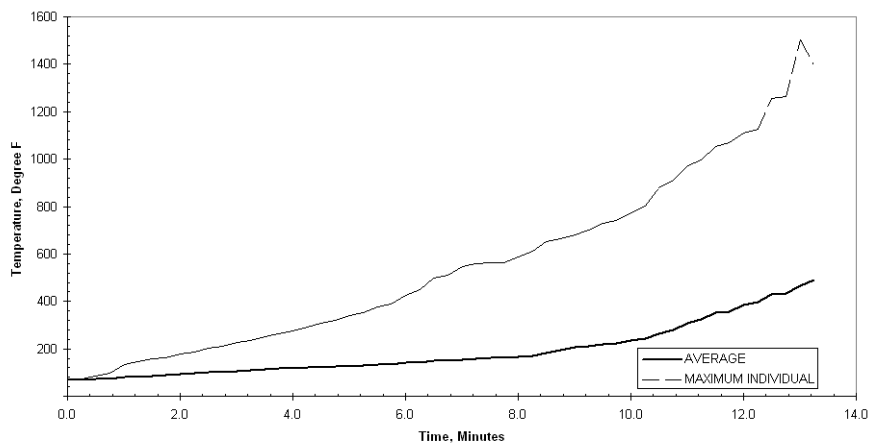

Figure 43 – Plot of Temperature of the Carpet Padding vs. Time

Temperatures of the Unexposed Surface – The average and maximum temperatures of the unexposed surface just before the moment of collapse (13 min 20 sec) were 480°F and 1273°F respectively. The individual temperature was recorded by thermocouple number 80. A plot of these temperatures can be seen on Figure 44.

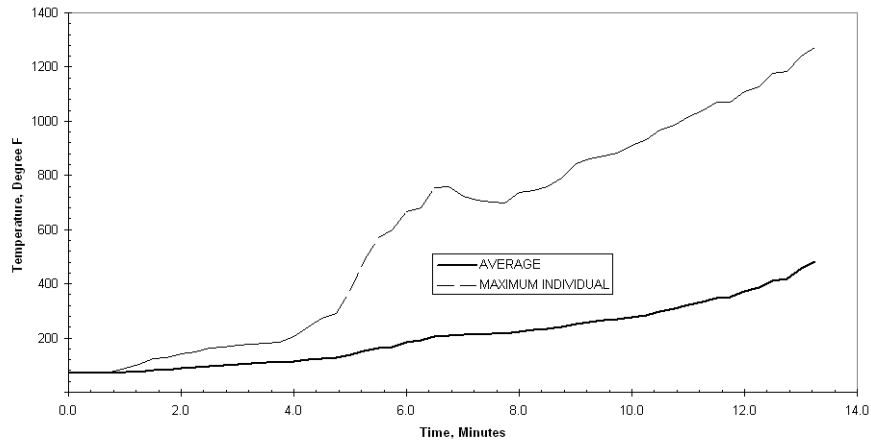

Figure 44 – Plot of Temperatures of the Unexposed Surface vs. Time

Temperatures of the LVL Assembly and Metal Connectors – The average and maximum temperatures of the LVL assembly and metal connectors just before the moment of collapse (13 min 15 sec) were 1347°F and 1367°F respectively. The individual temperature was recorded by thermocouple number 91. A plot of these temperatures can be seen on Figure 45. All temperatures on the LVL and metal connectors were observed to be similar.

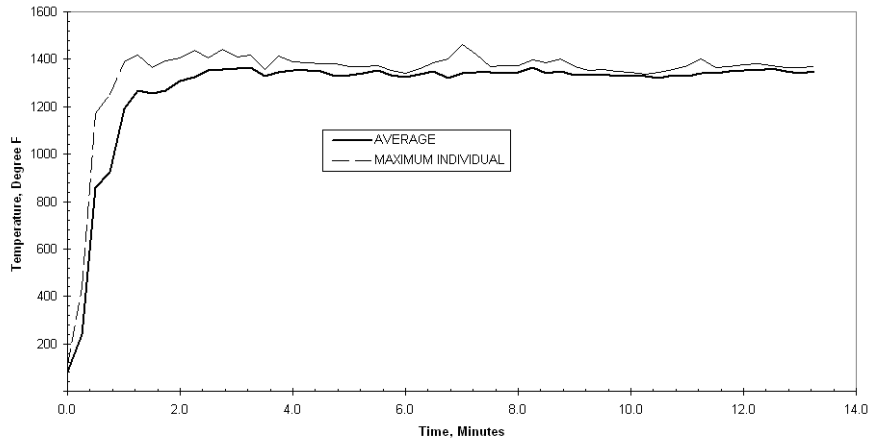

Figure 45 – Plot of Temperatures of the LVL Assembly and Metal Connectors vs. Time

Deflection of the Assembly - The deflection of the floor-ceiling assembly during the fire test is shown on Figure 46. The location of each deflection transducer can be seen in Appendix A under Test Assembly 3.

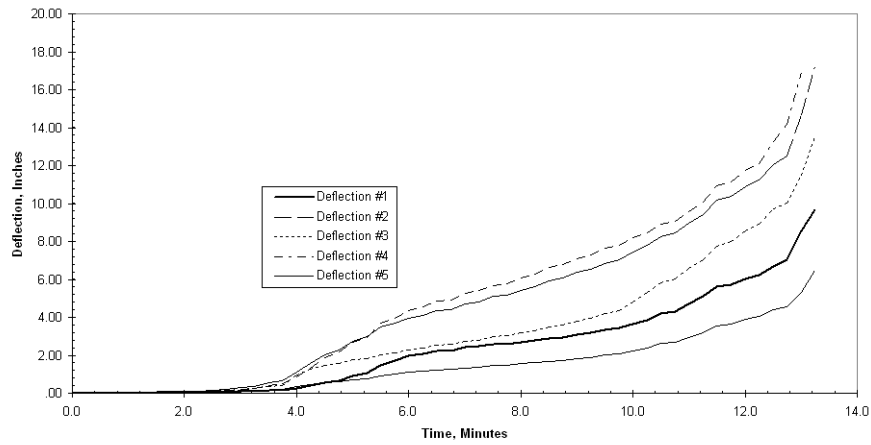

Figure 46 – Plot of Deflections vs. Time

Discussion

Furnace Conditions

The average temperatures within the furnace for the three tests were plotted for comparison in Figure 46

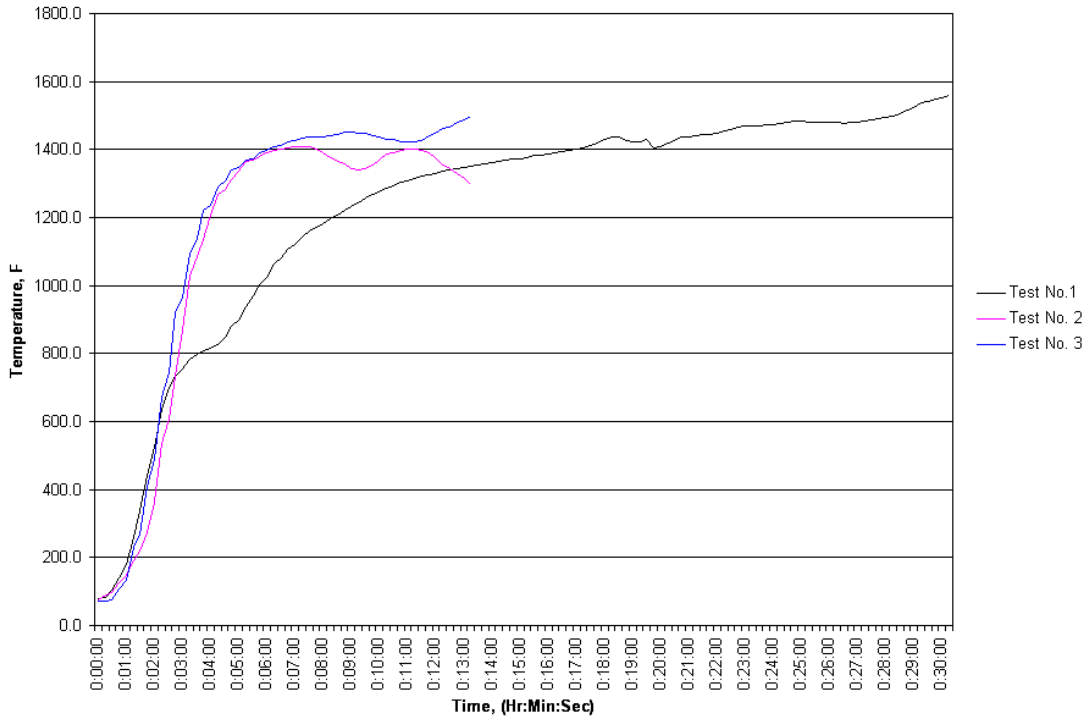

Figure 47 - Furnace Temperature vs. Time

The furnace temperature during the initial portion of Test Nos. 2 and 3 were significantly higher than recorded during Test No. 1 because the combustible supports and sub-floors for both of these assemblies were exposed to the furnace fire at the start of the test.

The oxygen content within furnace for the three tests were plotted for comparison in Figure 46

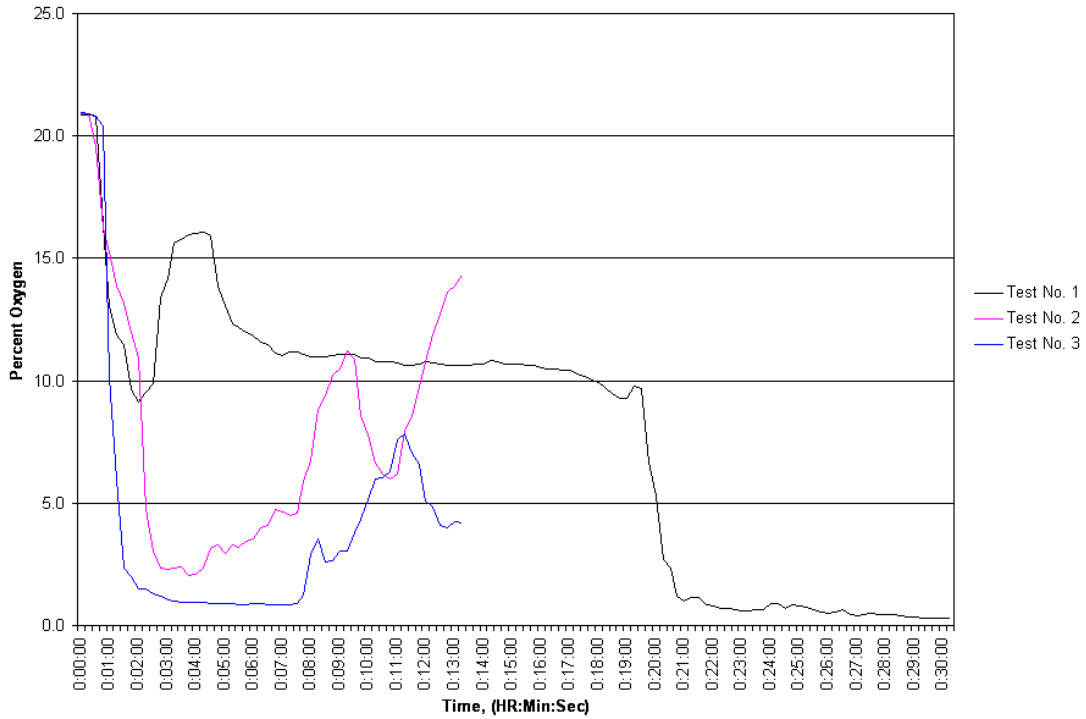

Figure 48 - Percent Oxygen vs. Time

The percent oxygen content at the beginning of the tests was approximately 20 to 23 percent and was reduced to approximately 9 percent during the tests when the ceiling was in place. The percent oxygen content dropped to near zero after the ceilings fell and the combustible supports and sub-floor were exposed to the furnace flames.

Overall, the conditions within the furnace during each of the three fire tests were sufficiently similar to enable a comparison of the structural performance of the samples when considering the state of the test samples.

Table 6 provides a summary of the temperature data for assemblies 1 through 3

Table 6 - Average temperature on exposed surface of sub-floor and average temperature on unexposed surface of floor.

Assembly No.	Average temperature of exposed (lower) surface of sub-floor 30 second before collapse (°F)	Average temperature of unexposed (upper) surface of floor 30 second before collapse (°F)
1	1444	171
2	1344	242
3	1346	419

It should be noted the relatively low temperatures on the surface viewed by the thermal imaging camera shortly before collapse as compared to the surface temperature of the sub-floor exposed to the fire.

Structural Serviceability

Firefighters have expressed concern about the rate of structure's deflection prior to collapse when reporting on experiences upon entering a fire scene and performing life safety and fire extinguishment activities. The firefighters' reports indicate the lightweight wood construction collapses at a quicker rate as compare to floors supported by 2 x 10 in. dimensional lumber.

In addition to the fire resistance rating determined by the Conditions of Acceptance in ASTM E119, a finish rating is typically published for fire resistive assemblies with combustible supports such as the tested samples. The finished rating is defined as the time when the first occurrence of either:

3. Temperature measured on the face of the combustible supports nearest to the fire increases more than 325 °F; or
4. Average temperature measured on the face of the combustible supports nearest the fire increases more than 250 °F.

Several fire test standards similar to ASTM E119 such as ISO 834:1 (Fire-resistance tests – Elements of building construction – Part 1: General requirements) define load bearing capacity as the elapsed time that a test sample is able to maintain its ability to support the applied load during the fire test. The ability to support the applied load is determined when both:

3. Deflection exceeds: $\frac{L^2}{400d}$; and
4. When the deflection exceeds $\frac{L}{30}$, the Rate of Deflection exceeds: $\frac{L^2}{9000d}$
 where L is the clear span measured in millimeters and d is the distance from the extreme fiber of the design compression zone to the extreme fiber of the design tensile zone of the structural element as measured in millimeters.

Other significant data obtained during the fire tests included observation of the conditions of the ceiling and floor surfaces, temperatures in the concealed space above the ceiling membrane and deflections of the floor and roof surfaces.

The finish rating and the load bearing capacity of Benchmark assemblies from the AFG sponsored project and the three tested assemblies are summarized in Table 7.

Table 7 - Summary of Significant Events in Addition to ASTM E119 Conditions of Acceptance

Test Assembly No.	Initial falling of ceiling material (More than 1 ft²) (min:sec)	Average temperature on unexposed surface of ceiling at initial falling (°F)	Finish rating (min:sec)	Load bearing Capacity (min)
--------------------------	---	--	--------------------------------	------------------------------------

Test Assembly No.	Initial falling of ceiling material (More than 1 ft²) (min:sec)	Average temperature on unexposed surface of ceiling at initial falling (°F)	Finish rating (min:sec)	Load bearing Capacity (min)
Benchmark1 ¹	No ceiling	No Ceiling	00:45	18
Benchmark2 ²	16:00	559	12:15	25
Benchmark3 ³	16:30	519	10:45	24
Benchmark4 ⁴	23:30	605	15:30	45
Benchmark5 ⁵	74:00**	1109	74:00**	80
1	17:15	646	13:00	24
2	No ceiling	No ceiling	00:15	10
3	No ceiling	No ceiling	00:30	5

** - plaster ceiling in contact with furnace thermocouples at 51 minutes

Notes:

- 1 – Benchmark 1 data represents a combustible floor-ceiling assembly of typical unprotected legacy construction (2 x 10) without a ceiling
- 2 – Benchmark 2 data represents a combustible floor-ceiling assembly of typical modern construction of parallel chord truss with glued connections with a ½ thick regular gypsum board ceiling
- 3 – Benchmark 3 data represents a combustible floor-ceiling assembly of typical modern construction of parallel chord truss with steel gusset connections with a ½ thick regular gypsum board ceiling
- 4 – Benchmark 4 data represents a combustible floor-ceiling assembly of typical protected legacy construction (2 x 10) with a ½ inch regular gypsum board ceiling
- 5 – Benchmark 5 data represents a combustible floor-ceiling assembly of typical protected legacy construction (2 x 10) with a ¾ inch metal lath and plaster ceiling

Summary of Findings

The following summarizes the key findings documented in this report:

From the previous AFG sponsored project, it was determined that the fire containment performance (load bearing capacity) of a combustibile floor-ceiling assembly representing typical unprotected legacy construction (2 x 10) without a ceiling was 18 minutes. The time duration was based upon the performance of the assembly when exposed to the time-temperature curve defined in Standard ASTM E119. This was defined as the benchmark (Benchmark 1) fire resistance performance of traditional exposed lumber construction typically found in lowest floor above basement or crawl spaces.

- The fire containment performance of Test Assembly 1 representing modern steel gusset truss construction with a ceiling with penetrations was 6 minutes more than the benchmark performance.
- The fire containment performance of Assembly 2 representing unprotected modern glued truss construction was 8 minutes less than the benchmark performance.
- The fire containment performance of Assembly 3 representing unprotected modern steel gusset construction with stairwell framing was 13 minutes less than the benchmark performance.

From the previous AFG sponsored project, it was determined that the fire containment performance (load bearing capacity) of a combustibile floor-ceiling assembly representing typical modern construction of parallel chord truss with glued connections with a ½ thick regular gypsum board ceiling was 25 minutes. The time duration was based upon the performance of the assembly when exposed to the time-temperature curve defined in Standard ASTM E119. This was defined as the benchmark (Benchmark 2) performance of modern glued joint truss construction with a regular gypsum board ceiling typically found in floors above living spaces.

- The fire containment performance of Assembly 2 without the ceiling was 15 minutes less than the benchmark performance.

From the previous AFG sponsored project, it was determined that the fire containment performance (load bearing capacity) of a combustibile floor-ceiling assembly representing typical modern construction of parallel chord truss with steel gusset connections with a ½ thick regular gypsum board ceiling was 24 minutes. The time duration was based upon the performance of the assembly when exposed to the time-temperature curve defined in Standard ASTM E119. This was defined as the benchmark (Benchmark 3) performance of modern metal gusset truss construction with a regular gypsum board ceiling typically found in floors above living spaces.

- The fire containment performance of Assembly 3 without the ceiling and framed with a stairwell opening was 19 minutes less than the benchmark performance.

From the previous AFG sponsored project, it was determined that the fire containment performance (load bearing capacity) of a combustible floor-ceiling assembly representing typical protected legacy construction (2 x 10) with a ½ inch regular gypsum board ceiling was 45 minutes. The time duration was based upon the performance of the assembly when exposed to the time-temperature curve defined in Standard ASTM E119. This was defined as the benchmark (Benchmark 4) performance of traditional lumber construction with a regular gypsum board ceiling typically found in floors above living spaces.

- The fire containment performance of Assembly 1 was 21 minutes less than the benchmark performance.
- The fire containment performance of Assembly 2 was 35 minutes less than the benchmark performance.
- The fire containment performance of Assembly 3 was 40 minutes less than the benchmark performance.

From the previous AFG sponsored project, it was determined that the fire containment performance (load bearing capacity) of a combustible floor-ceiling assembly representing typical protected legacy construction (2 x 10) with a ¾ inch metal lath and plaster ceiling was 80 minutes. The time duration was based upon the performance of the assembly when exposed to the time-temperature curve defined in Standard ASTM E119. This was defined as the benchmark (Benchmark 5) performance of traditional lumber construction with a metal lath and plaster ceiling typically found in floors above living spaces.

- The fire containment performance of Assembly 1 was 56 minutes less than the benchmark performance.
- The fire containment performance of Assembly 2 was 70 minutes less than the benchmark performance.
- The fire containment performance of Assembly 3 was 75 minutes less than the benchmark performance.

Appendix A – Location of Instrumentation

The location of instrumentation and materials such as thermocouples, deflection transducers, accelerometers, camera locations, joist and truss members, subflooring and finish flooring, and loading conditions are described in this Appendix.

General

Furnace Thermocouples – There were a total of 16 furnace thermocouples space symmetrically throughout the furnace in rows of four.

Assembly No. 1:

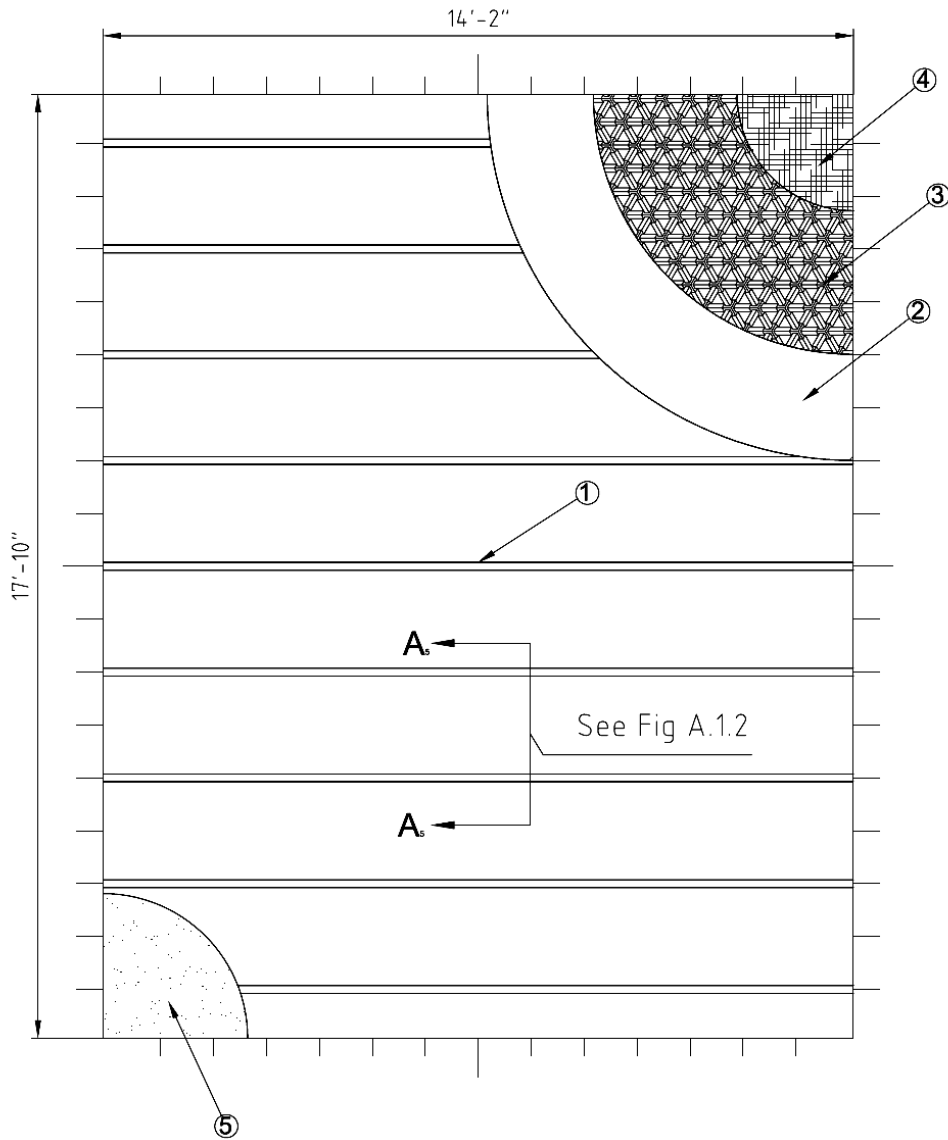

- 1) 14 in. wood truss with metal gussets spaced 24 in. O.C. supplied with bottom chord splices with strongback.
- 2) OSB $\frac{23}{32}$ in. APA rated sheathing, T&G $\frac{48}{24}$ span rating.
- 3) Standard carpet padding.
- 4) Standard carpeting.
- 5) $\frac{1}{2}$ in. thick regular gypsum wallboard.

Figure A.1.1 – Construction Layout.

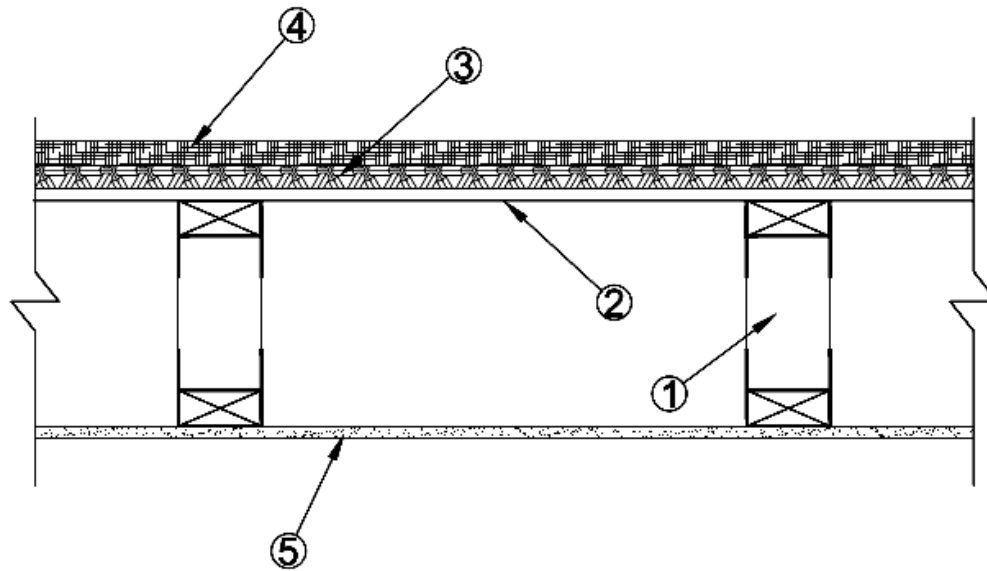
Assembly No. 1

- 1) 14 in. wood truss with metal gussets spaced 24 in. O.C. supplied with bottom chord splices with strongback.
- 2) OSB $\frac{23}{32}$ in. APA rated sheathing, T&G $\frac{48}{24}$ span rating.
- 3) Standard carpet padding.
- 4) Standard carpeting.
- 5) $\frac{1}{2}$ in. thick regular gypsum wallboard.

Figure A.1.2 – Construction Layout Section A₁-A₁.

Assembly No. 1

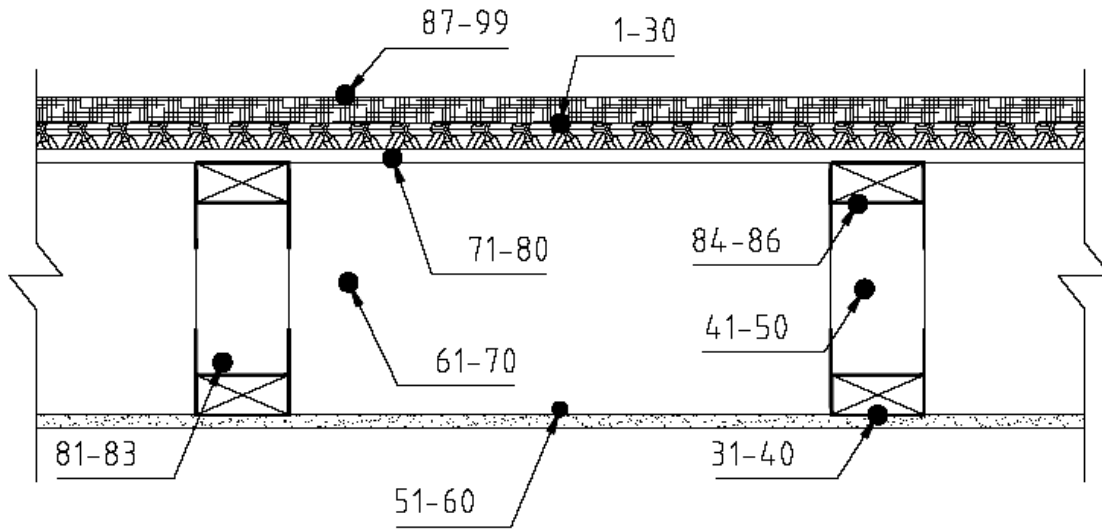

TC # LOCATION

- 1-30 On Carpet padding and subfloor
- 31-40 On bottom of wood truss (finish rating)
- 41-50 On side of wood truss at mid depth, facing North
- 51-60 On back of gypsum panels
- 61-70 Mid depth
- 71-80 On bottom of subfloor
- 81-83 On bottom metal gusset plate, nearest center of assembly , facing north
- 84-86 On top metal gusset plate, nearest center of assembly, facing north.
- 87-99 On unexposed surface.

Figure A.1.3 – Thermocouple Locations - Elevation.

Assembly No. 1

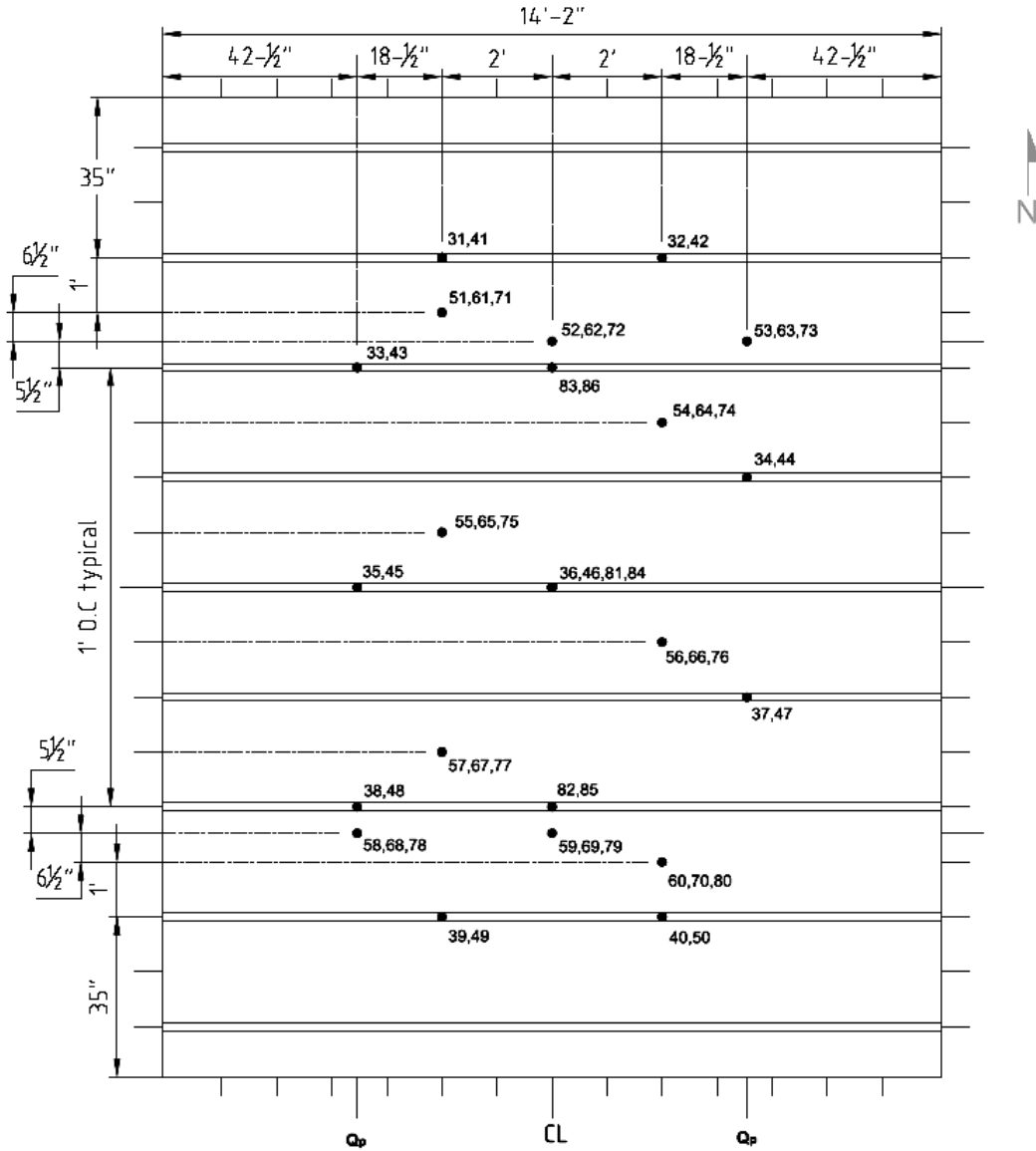

Figure A.1.4 – Thermocouple Locations on Wood Members and Bottom of Subfloor.

Assembly No. 1

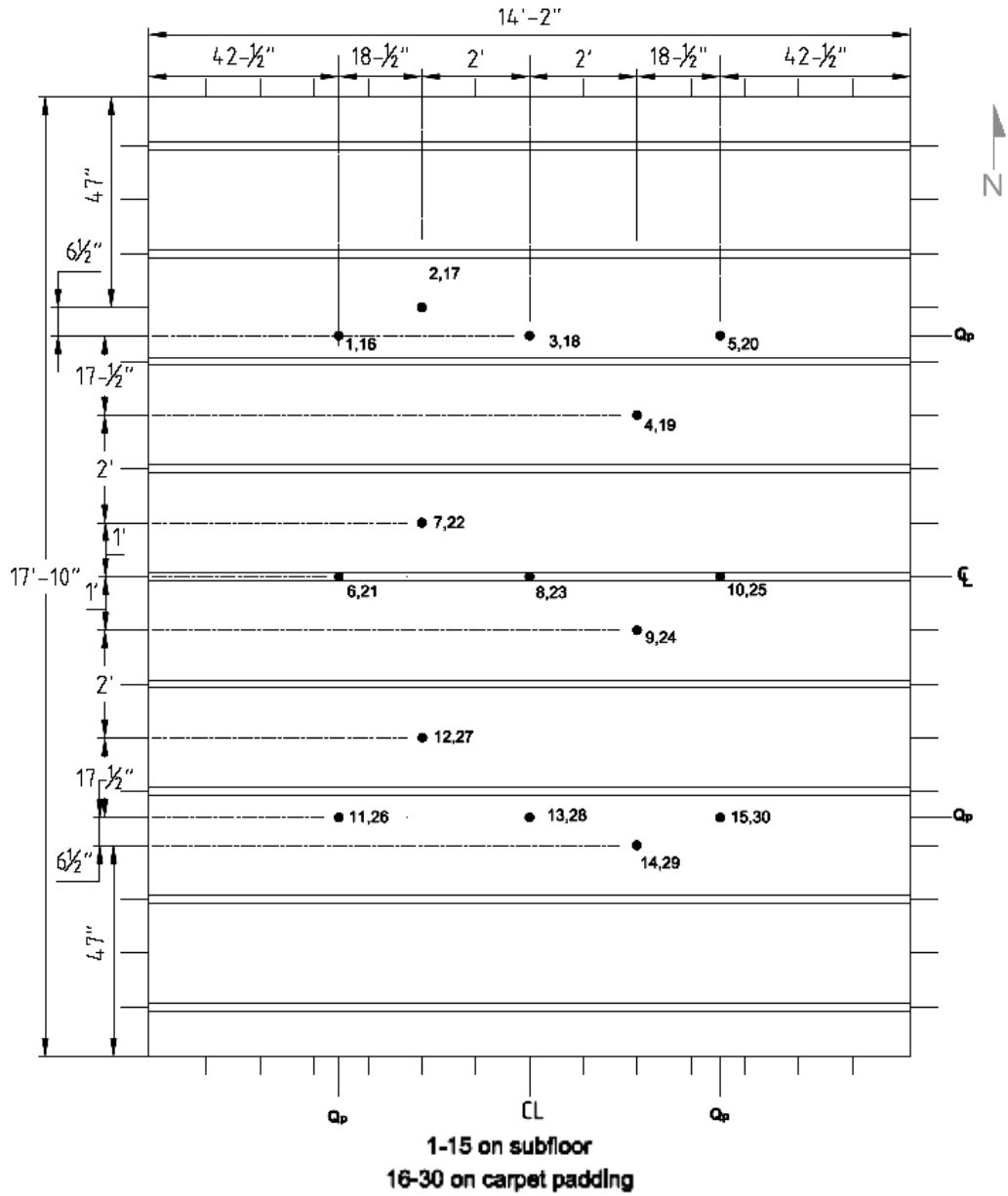

Figure A.1.5 – Thermocouple Locations on Top of Subfloor and Carpet Padding.

Assembly No. 1

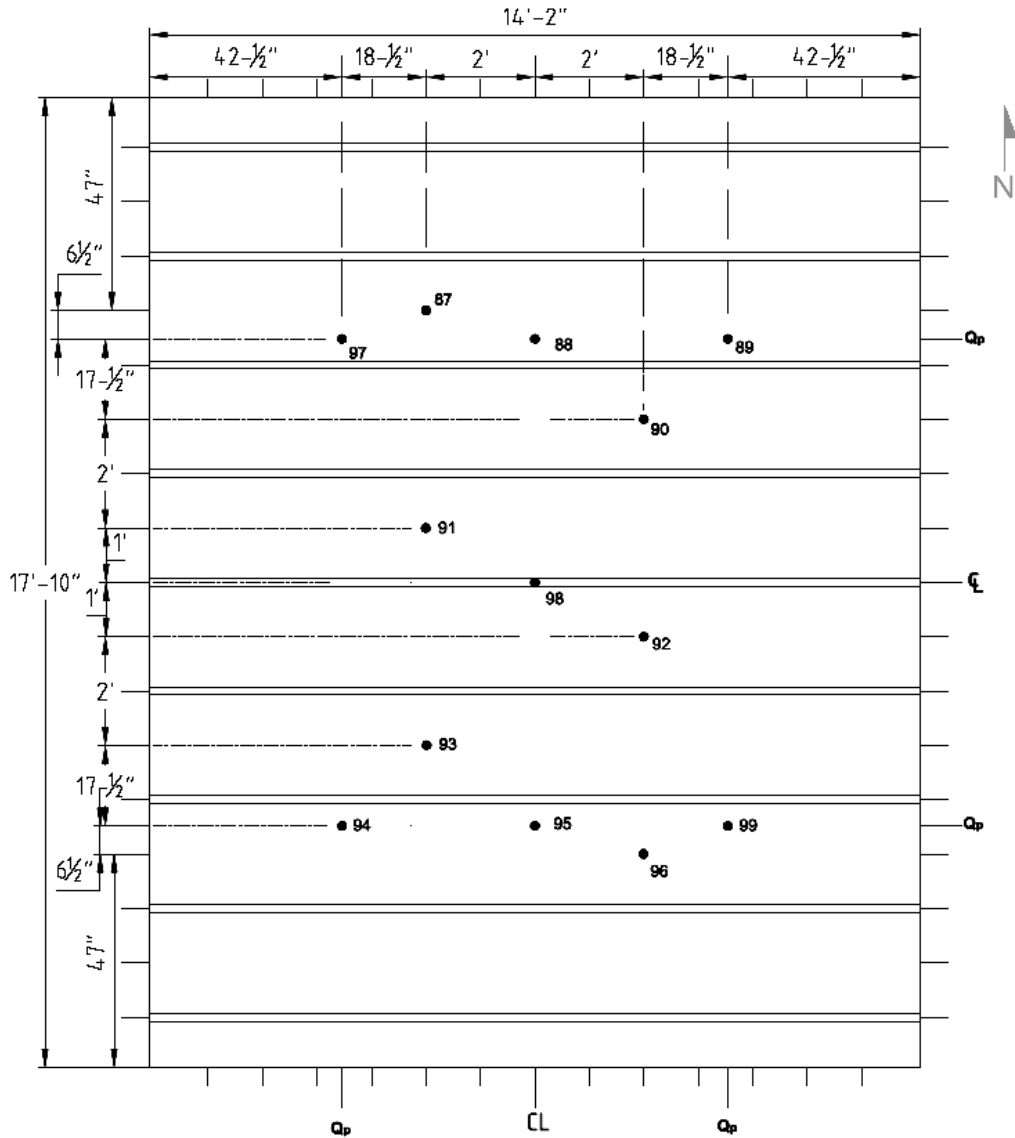
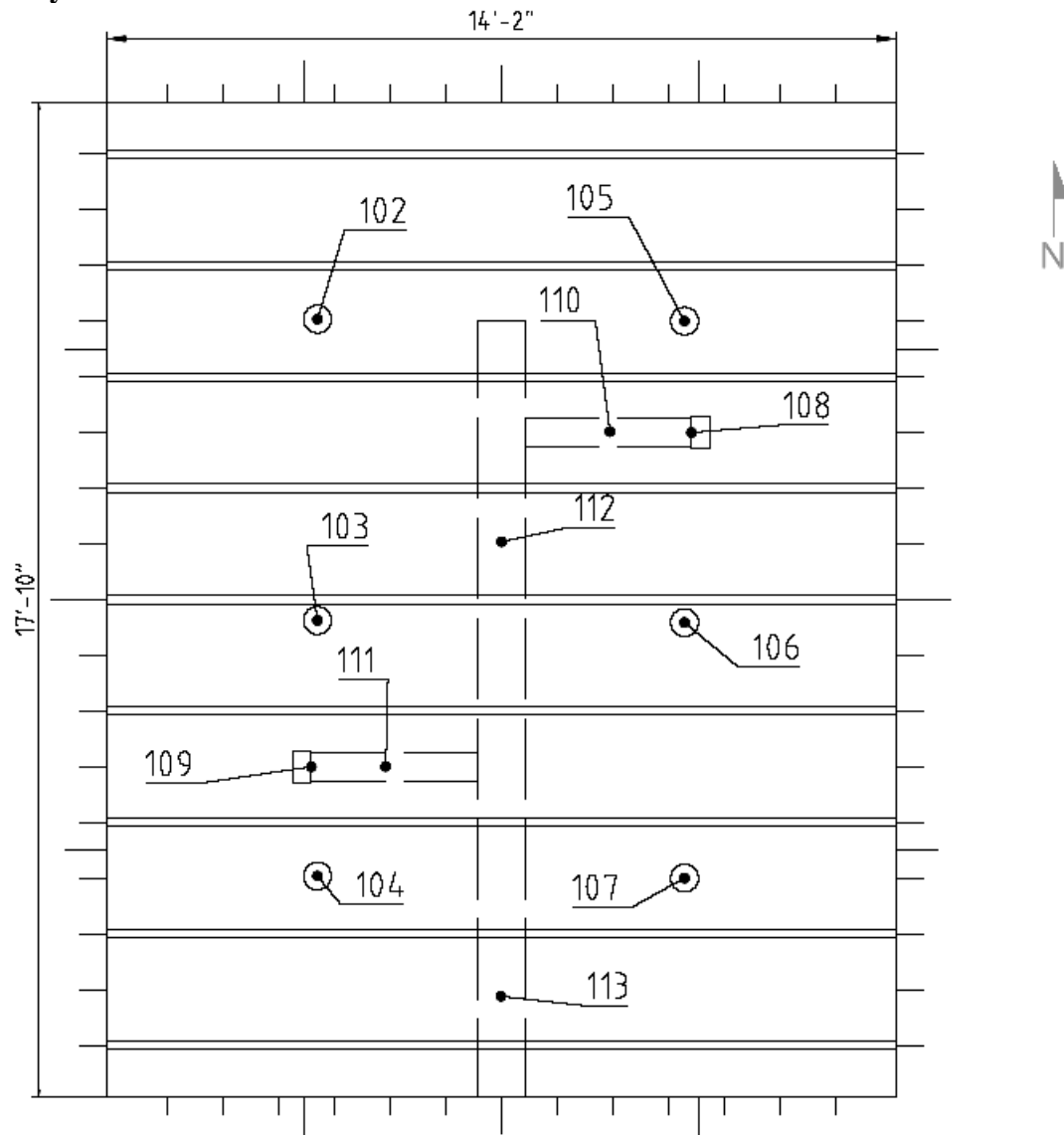

Figure A.1.6 – Thermocouple Locations on Unexposed Surface.

Assembly No. 1



- 102 - 107 - On top of can lights over can light venting
- 108 - 109 - On top fo flexible duct right before junction of supply register inlet.
- 110 - 111 - On top of flexible duct at mid span
- 112 - 113 - On top of ridged supply duct.

Figure A.1.7 – Thermocouple Locations on Ducts and Can Lights

Assembly No. 1

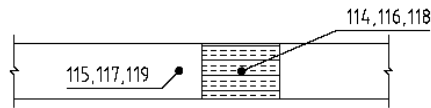
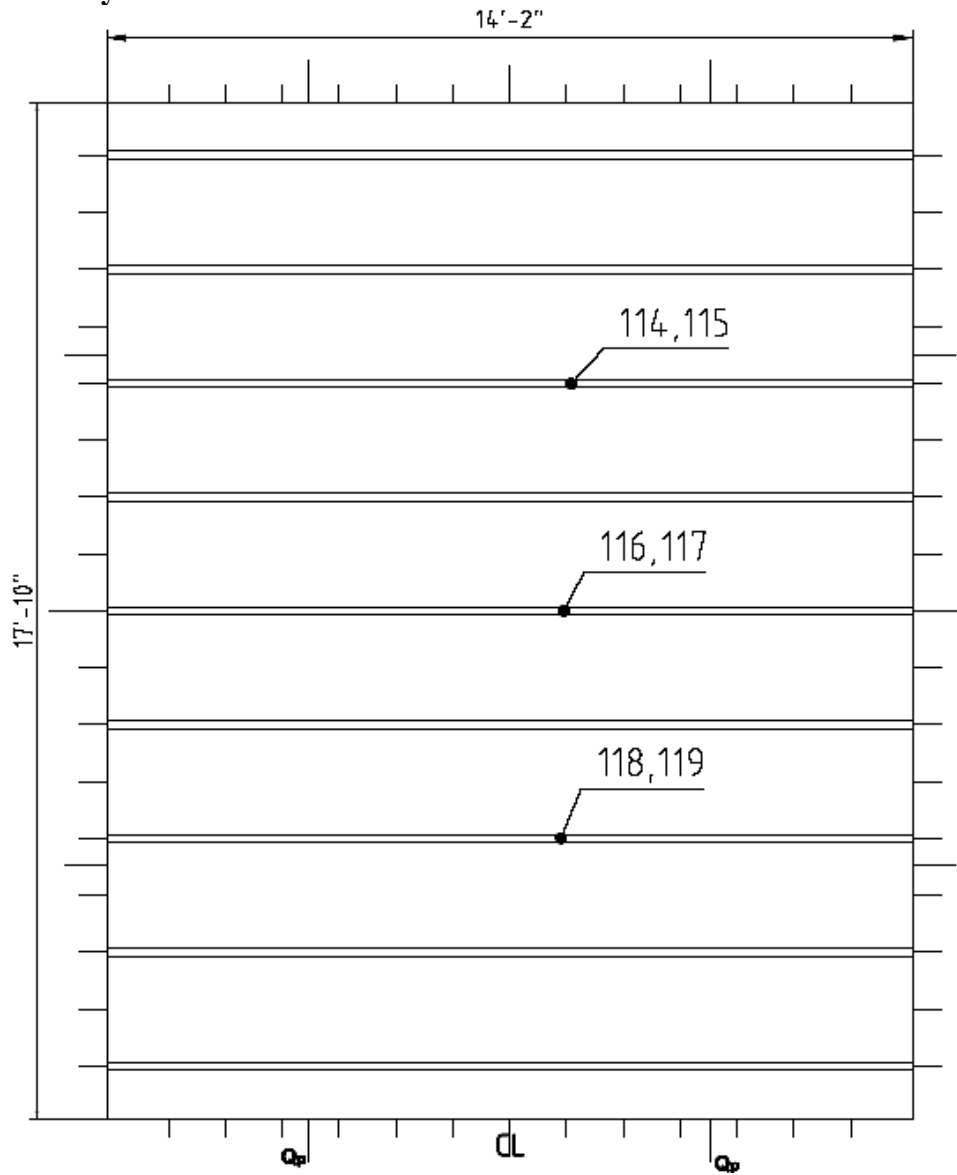

TC. No.	Location
114, 116, 118	Behind metal gusset splice plate on bottom of truss.
115, 117, 119	On 2x4 member, 2 in. west of edge of bottom metal gusset splice plate.

Note: All thermocouples facing north.

Figure A.1.8 – Thermocouple Locations on Metal Gusset Plates

Assembly No. 1

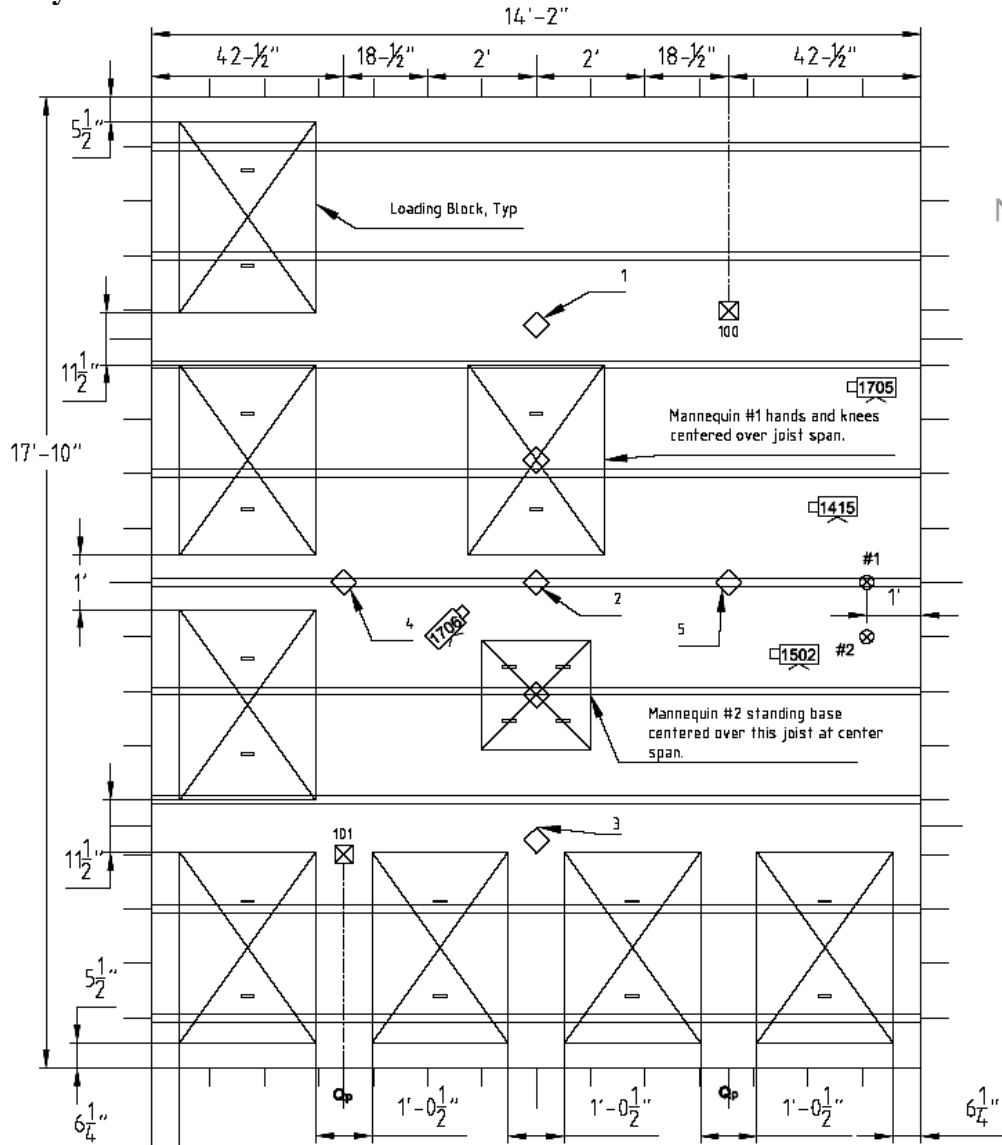

Figure A.1.9 – Loading and Instrumentation Layout (See Figure A.1.10).

Assembly No. 1

Deflection Transducers:

- 1 - Along E-W Centerline, North Quarter-point.
- 2 - Along E-W Centerline, Center-point.
- 3 - Along E-W Centerline, South Quarter-point.
- 4 - Along N-S Centerline, West Quarter-point.
- 5 - Along N-S Centerline, East Quarter-point.

Accelerometers:

- 1- Over Joist, 12 in. from East edge of assembly.
- 2- Over Center of Span, 12 in. from East edge of assembly.

Audio Recordings: (Not Shown)

- 1 - Mannequin No. 1 (Hands & Knees)
- 2 - Mannequin No. 2 (Standing)

Video Camera Recordings: (Not Shown)

- Ch 1409 - Floor level view from Northeast corner
- Ch 1411 - IR camera from curing cell roof east center
- Ch 1412 - Furnace camera From Northwest corner
- Ch 1416 - Overhead from East center of assembly
- Ch 1413 - Overhead From South center of assembly
- Ch 1503 - Overhead from West center of assembly

Video Camera Recordings:

- Ch 1415 - Internal camera East (installed in joist cavity facing West - under kneeling mannequin #1 Includes canlight view.
- Ch 1502 - Internal camera East (installed in joist cavity facing west - under standing mannequin #2
- Ch 1705 - Internal camera installed in joist cavity facing West to obtain supply register view.
- Ch 1706 - Internal camera install in joist cavity facing East to obtain splice detail.

Plate thermocouples:

- 100 - In N.E. quadrant 100 mm below ceiling membrane.
- 101 - In S.W. quadrant 100 mm below ceiling membrane.

Furnace Pressure Probes: (Not shown)

- 1 - located near plate thermocouple No. 100
- 2 - located near plate thermocouple No. 101

Oxygen Content: (Not Shown)

located in E exhaust duct.

Figure A.1.10 – Loading and Instrumentation Key

Assembly No. 2

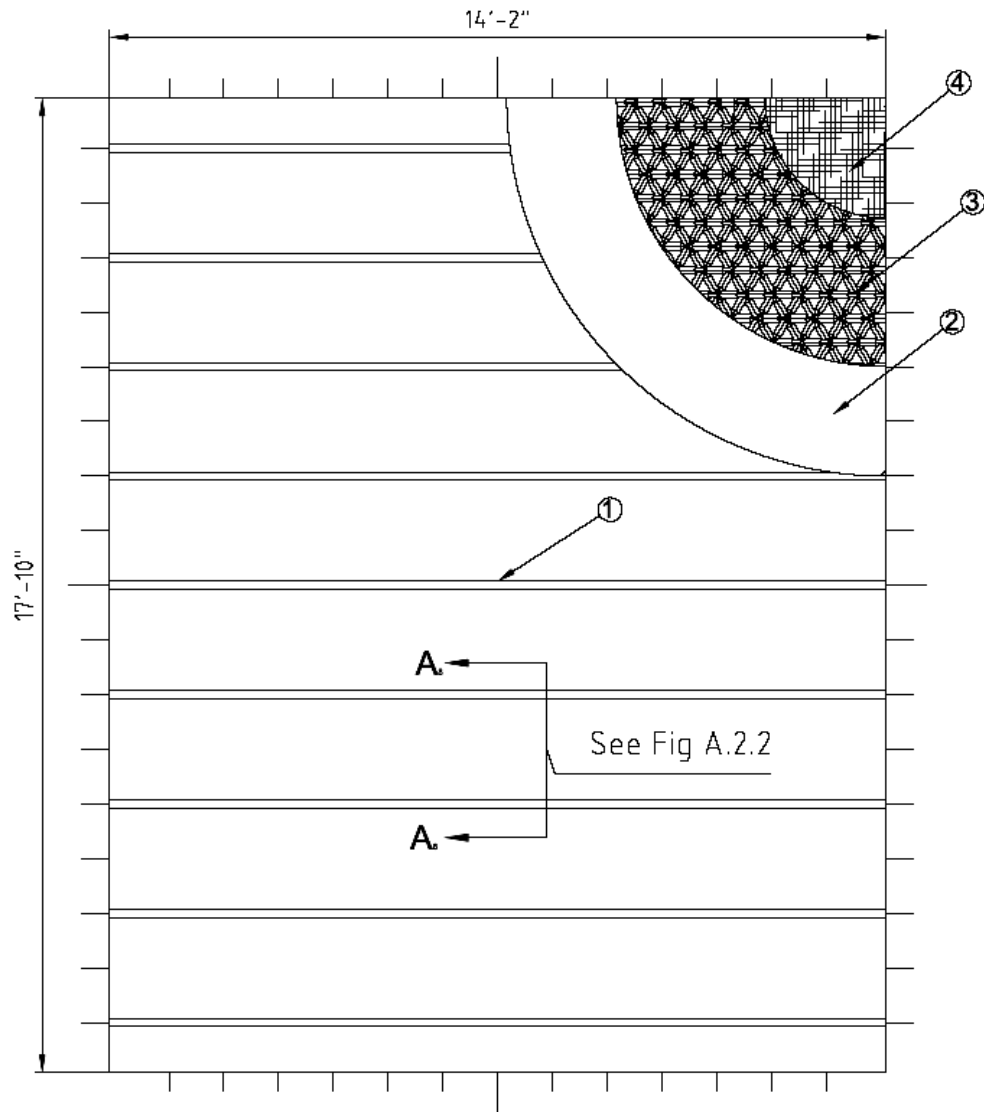
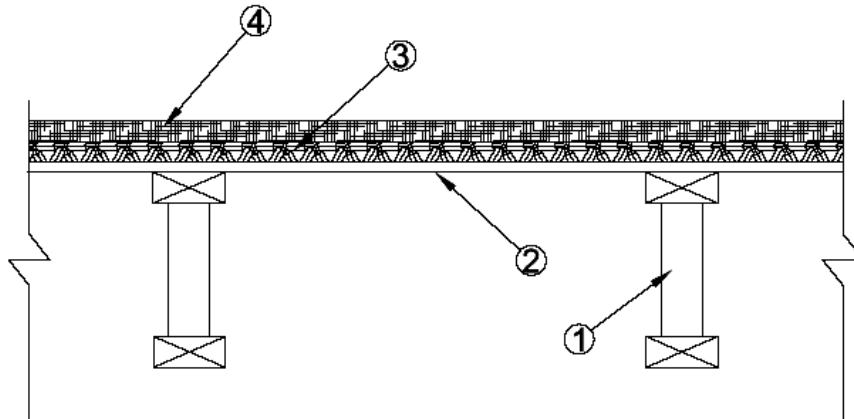

Figure A.2.1 – Construction Layout

Assembly No. 2



- 1) 14 in. Deep wood truss with glued finger joints spaced 24 in. O.C.
- 2) OSB $2\frac{3}{32}$ in. APA rated sheathing, T&G $\frac{48}{24}$ span rating.
- 3) Standard carpet padding.
- 4) Standard carpeting.

Figure A.2.2 – Construction Layout Section A₂-A₂.

Assembly No. 2

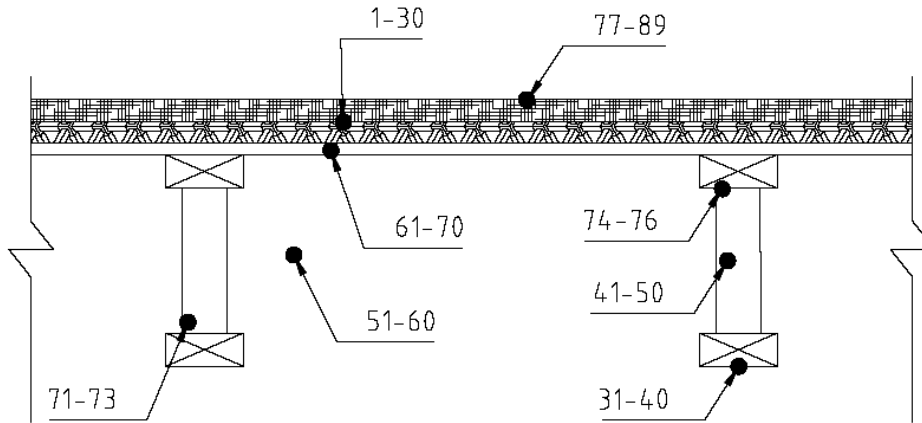

TC #	LOCATION
1-30	On subfloor and carpet padding
31-40	On bottom of wood truss (finish rating)
41-50	On side of wood truss at mid depth, facing North
51-60	Mid depth
61-70	On bottom of subfloor
71-73	On glued finger joint, nearest center of assembly, facing north
74-76	On glued finger joint, nearest center of assembly, facing north
77-89	On unexposed surface

Figure A.2.3 – Thermocouple Locations - Elevation.

Assembly No. 2

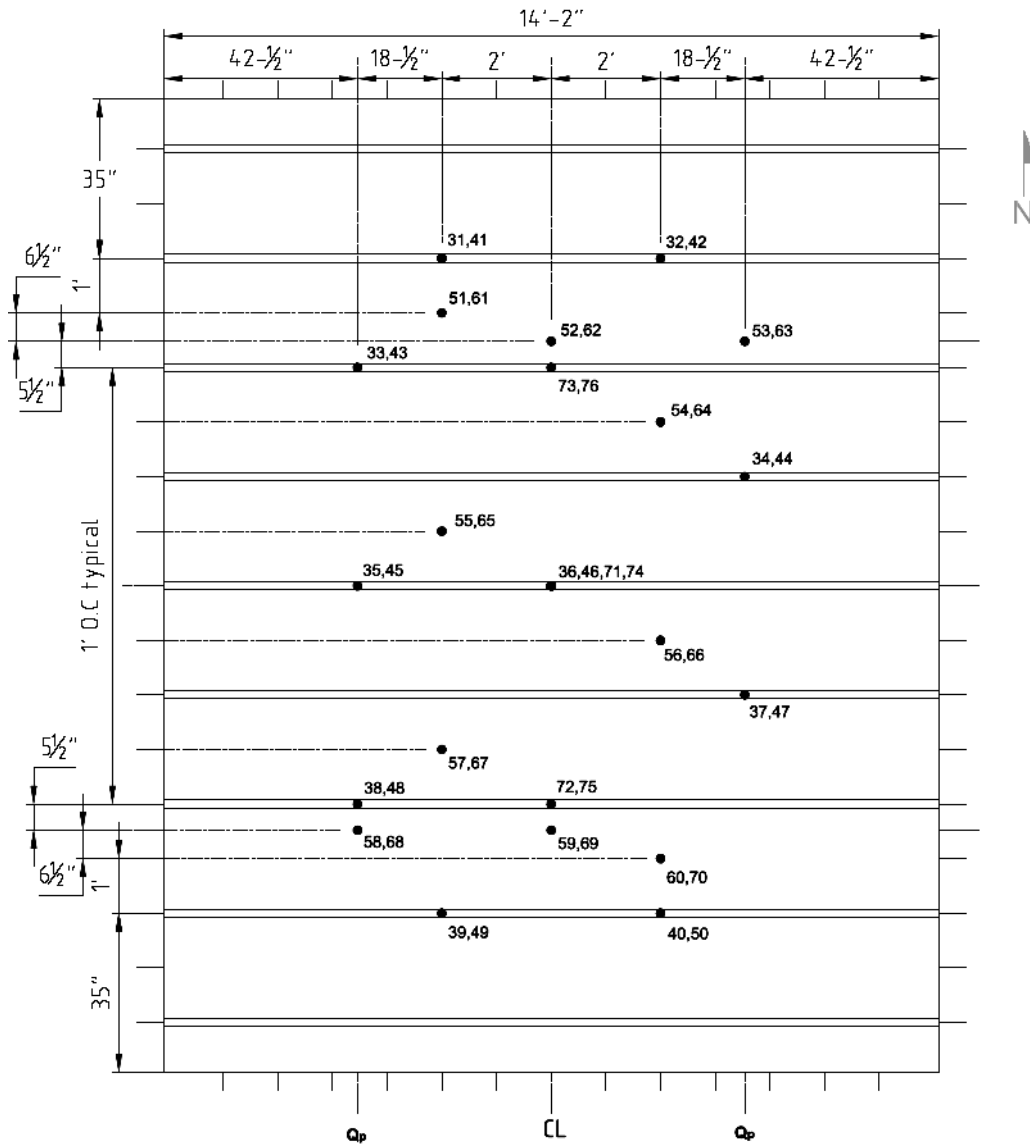

Figure A.2.4 – Thermocouple Locations on Wood Members and Bottom of Subfloor.

Assembly No. 2

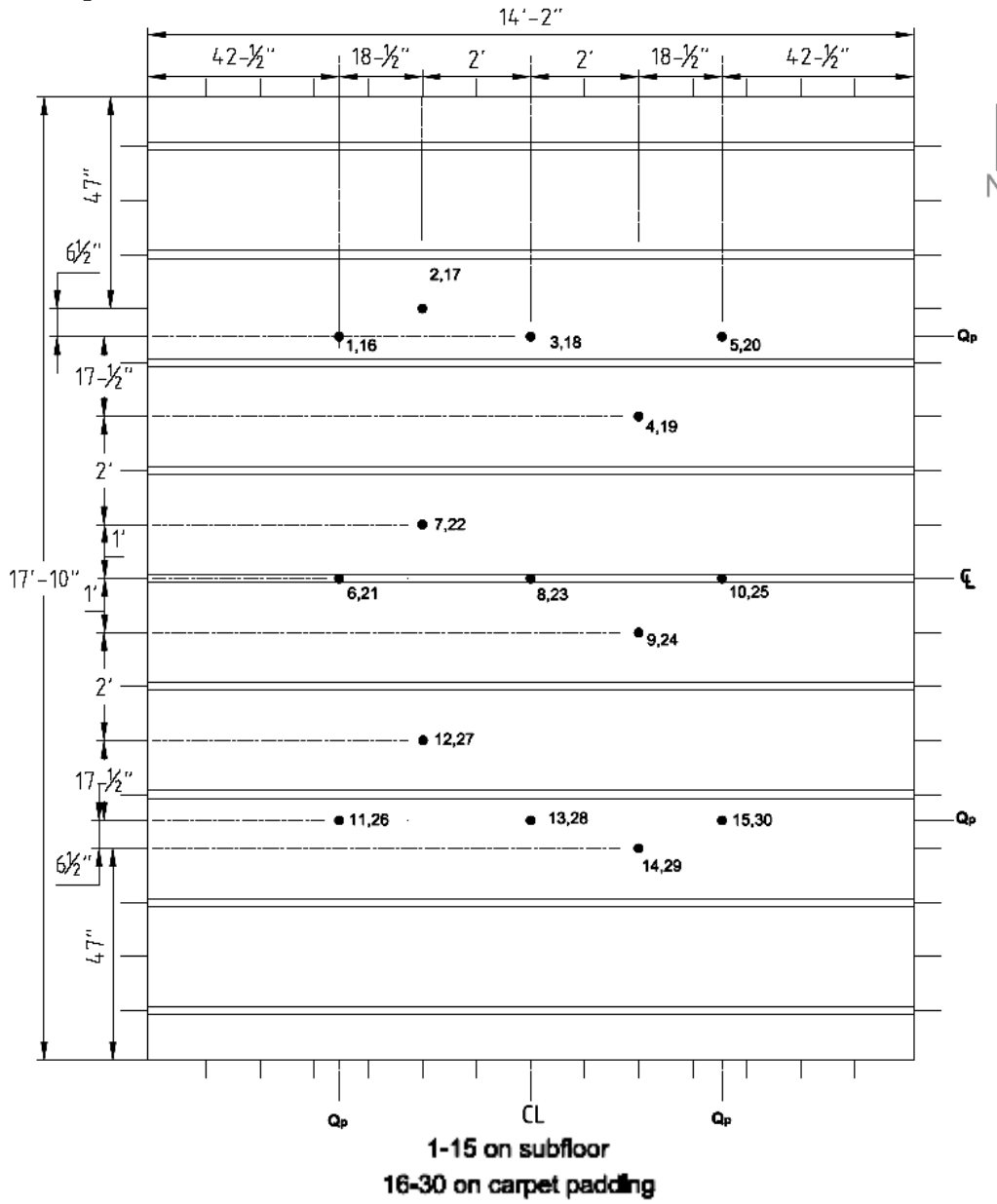

Figure A.2.5 – Thermocouple Locations on Subfloor and Carpet Padding.

Assembly No. 2

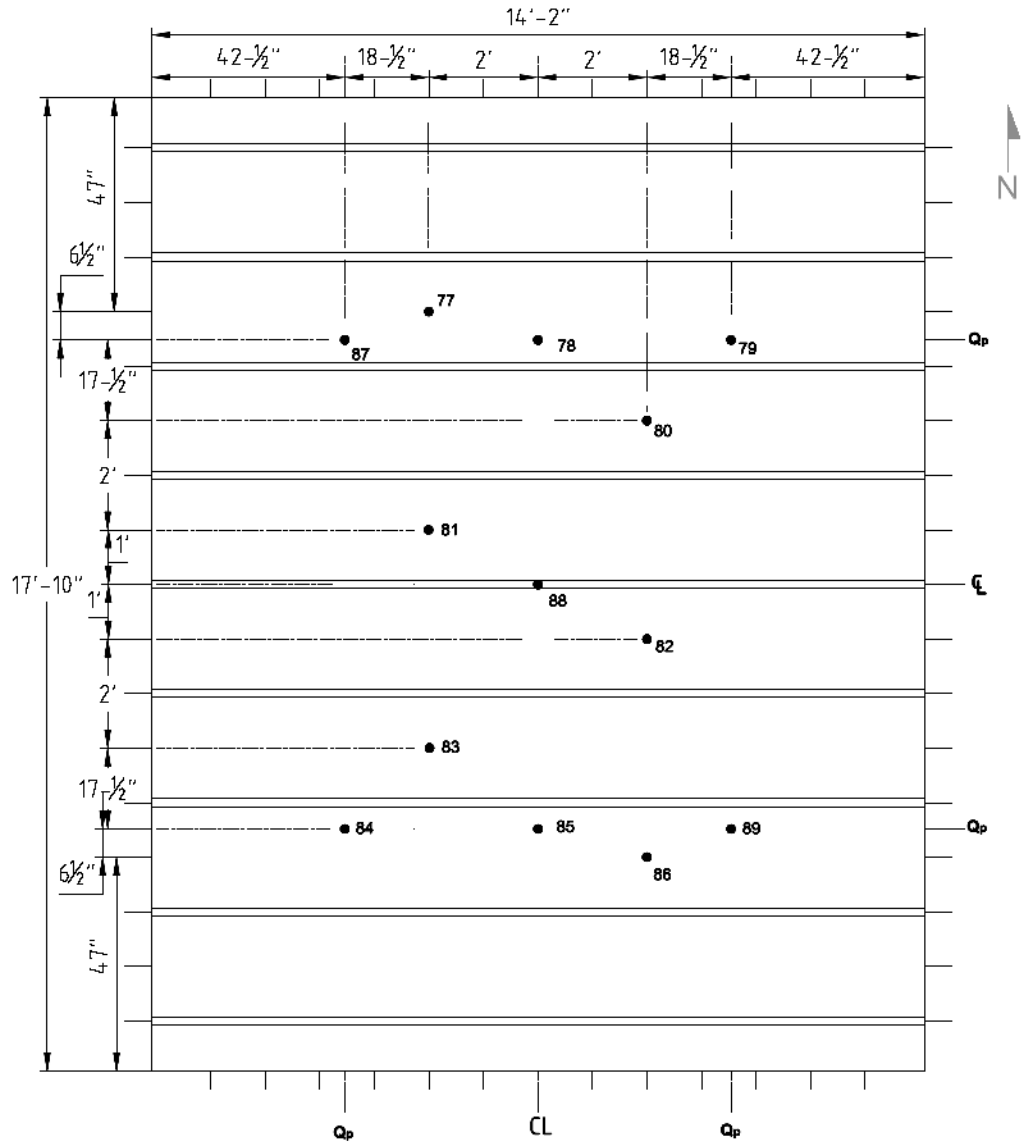

Figure A.2.6 – Thermocouple Locations on Unexposed Surface.

Assembly No. 2

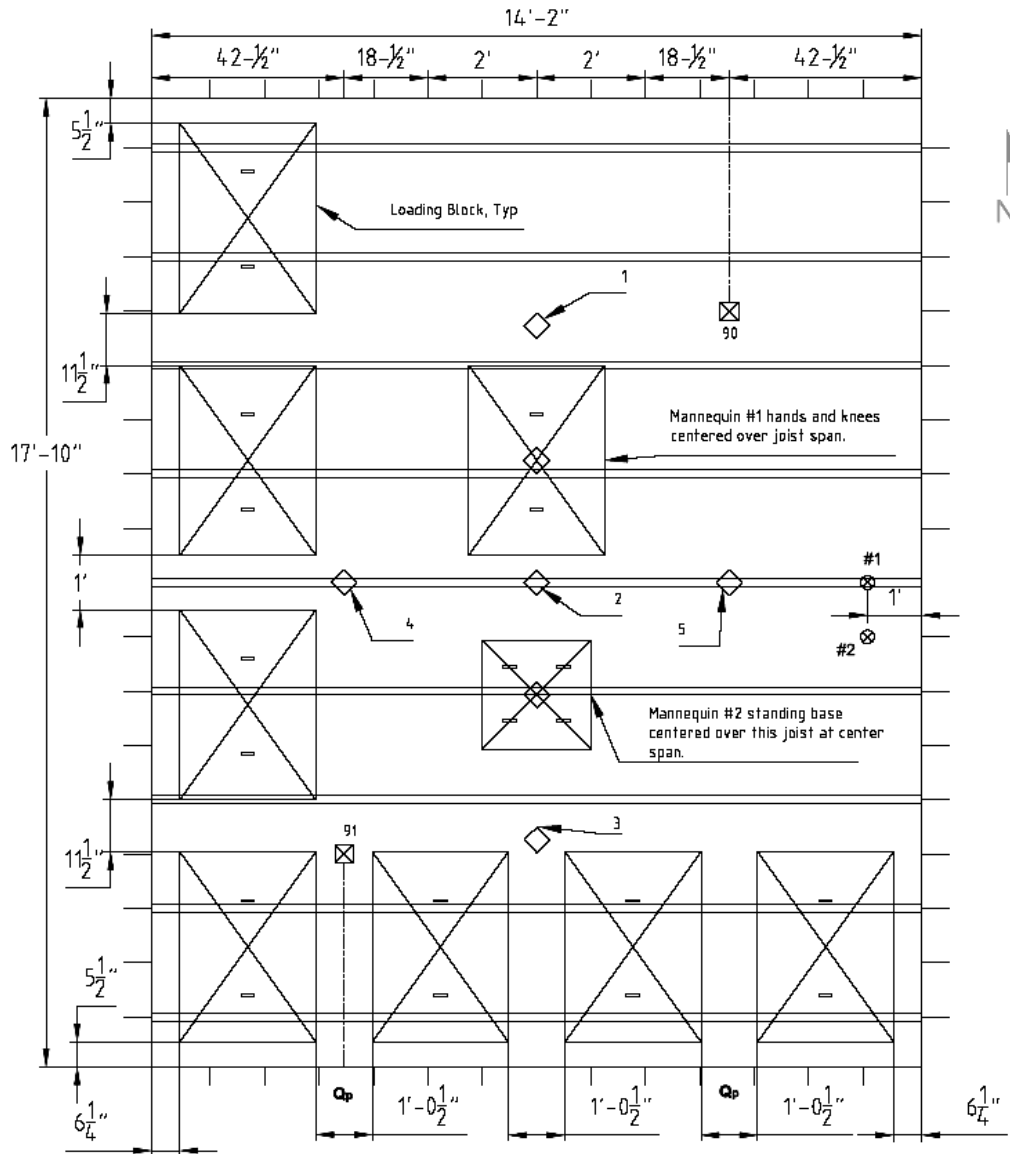



Figure A.2.7 – Loading and Instrumentation Layout (See Figure A.2.8).

Assembly No. 2**Deflection Transducers:** 

- 1 - Along E-W Centerline, North Quarter-point.
- 2 - Along E-W Centerline, Center-point.
- 3 - Along E-W Centerline, South Quarter-point.
- 4 - Along N-S Centerline, West Quarter-point.
- 5 - Along N-S Centerline, East Quarter-point.

Accelerometers: 

- 1- Over Joist, 12 in. from East edge of assembly.
- 2- Over Center of Span, 12 in. from East edge of assembly.

Audio Recordings: (Not Shown)

- 1 - Mannequin No. 1 (Hands & Knees)
- 2 - Mannequin No. 2 (Standing)

Video Camera Recordings: (Not Shown)

- Channel 1409 - floor level view from northeast corner
- Channel 1411 - IR camera from curing cell roof east center
- Channel 1412 - furnace camera from northwest corner
- Channel 1416 - overhead from east center of assembly
- Channel 1413 - overhead from south center of assembly
- Channel 1503 - overhead from west center of assembly

Plate Thermocouples: 

- 90 - in northeast quadrant 100mm below subfloor surface
- 91 - in southwest quadrant 100mm below subfloor surface

Furnace Pressure Probes: (Not Shown)

- 1 - located near plate thermocouple No. 100
- 2 - located near plate thermocouple No. 101

Oxygen Content : (Not Shown)

located in E exhaust duct.

Figure A.2.8 – Loading and Instrumentation Key

Assembly No. 3

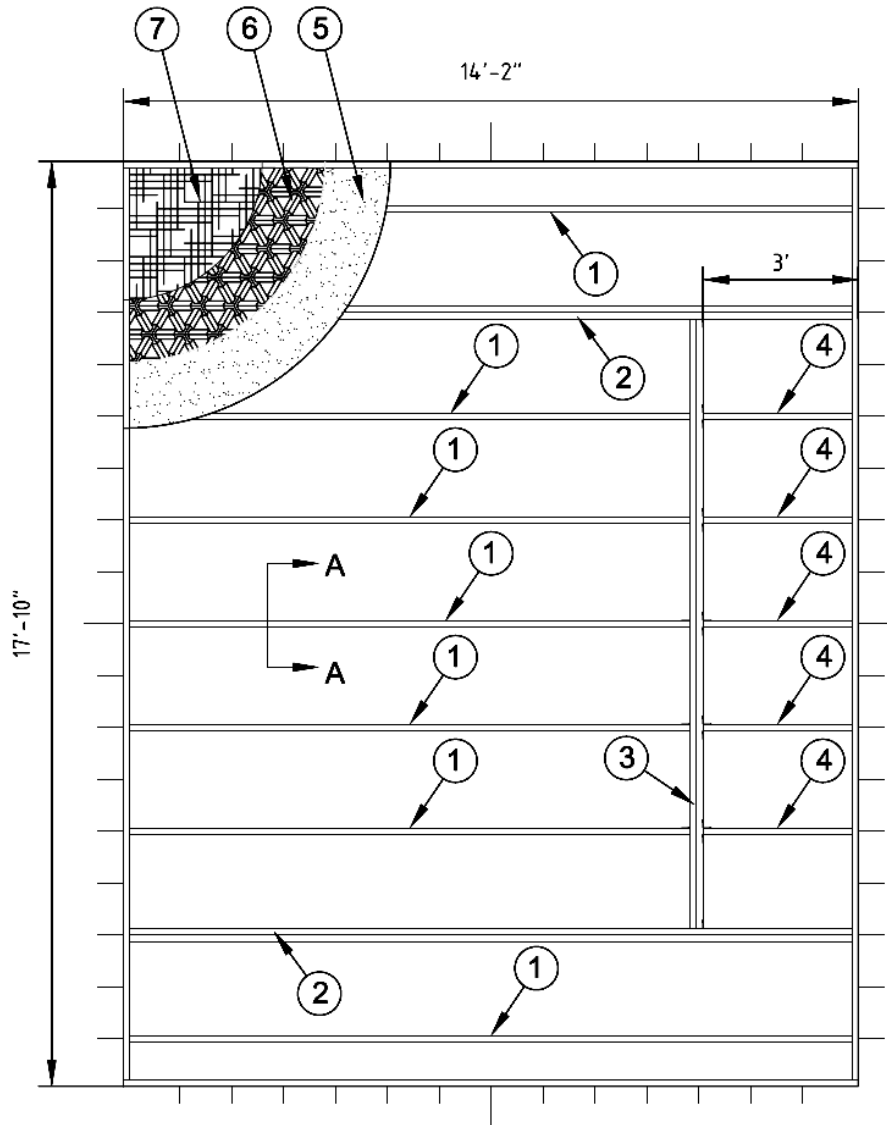

- 1) 14 in. deep wood truss with metal gusets spaced 24 in. O.C.
- 2) 14 in. deep wood truss girders
- 3) 14 in. deep LVL header.
- 4) 14 in. deep engineered I-Joist spaced 24 in. O.C.
- 5) OSB $\frac{23}{32}$ in. APA rated sheathing, T& G $\frac{48}{24}$ span rating.
- 6) Standard carpet padding
- 7) Standard carpeting.

Figure A.3.1 – Construction Layout.

Assembly No. 3

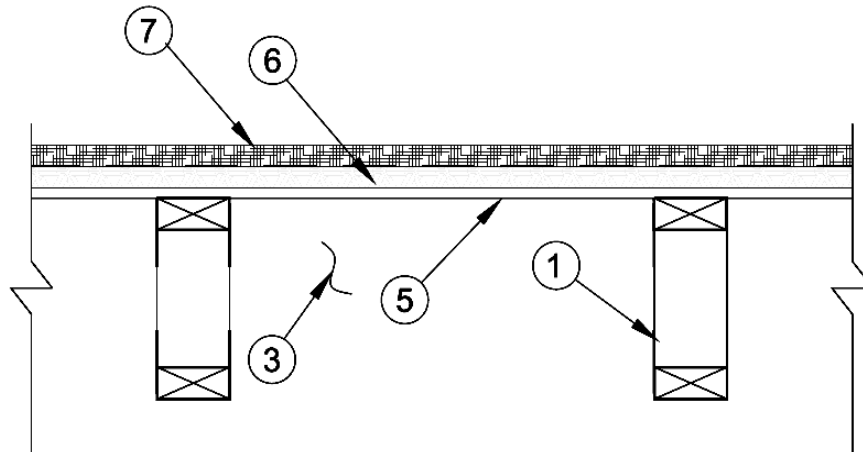

- 1) 14 in. deep wood truss with metal gusets spaced 24 in. O.C.
- 2) 14 in. deep wood truss girders
- 3) 14 in. deep LVL header.
- 4) 14 in. deep engineered I-Joist spaced 24 in. O.C.
- 5) OSB $\frac{23}{32}$ in. APA rated sheathing, T & G $\frac{48}{24}$ span rating.
- 6) Standard carpet padding
- 7) Standard carpeting.

Figure A.3.2 – Construction Layout Section A₃-A₃.

Assembly No. 3

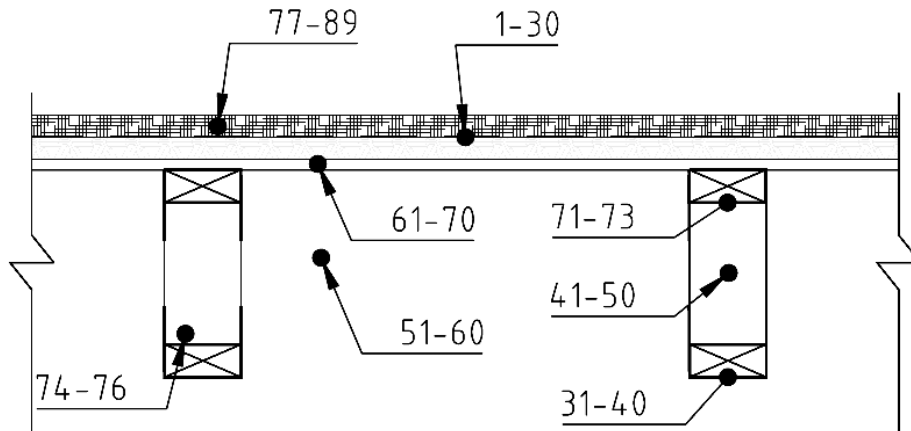

TC # Location

- 1-30 On carpet padding and subfloor
- 31-40 On bottom of wood members (finish rating)
- 41-50 On side of wood truss at mid depth, facing North
- 51-60 Mid depth
- 61-70 On bottom of subfloor
- 71-73 On top metal gusset plate, nearest center of assembly, facing North
- 74-76 On bottom of metal gusset plate, nearest center of assembly facing North
- 77-89 On unexposed surface.
- 90-97 Not show on this drawing

Figure A.3.3 – Thermocouple Locations - Elevation.

Assembly No. 3

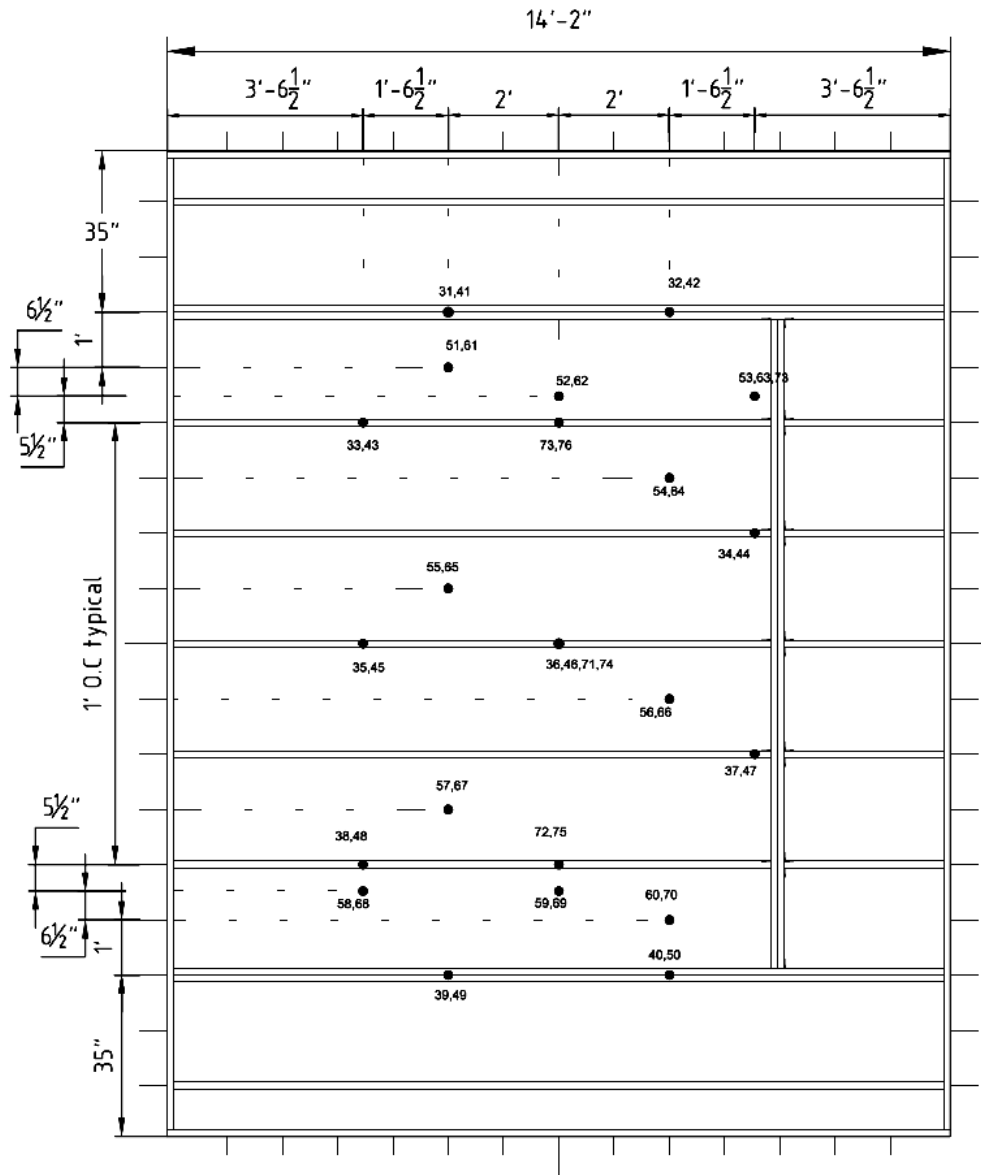
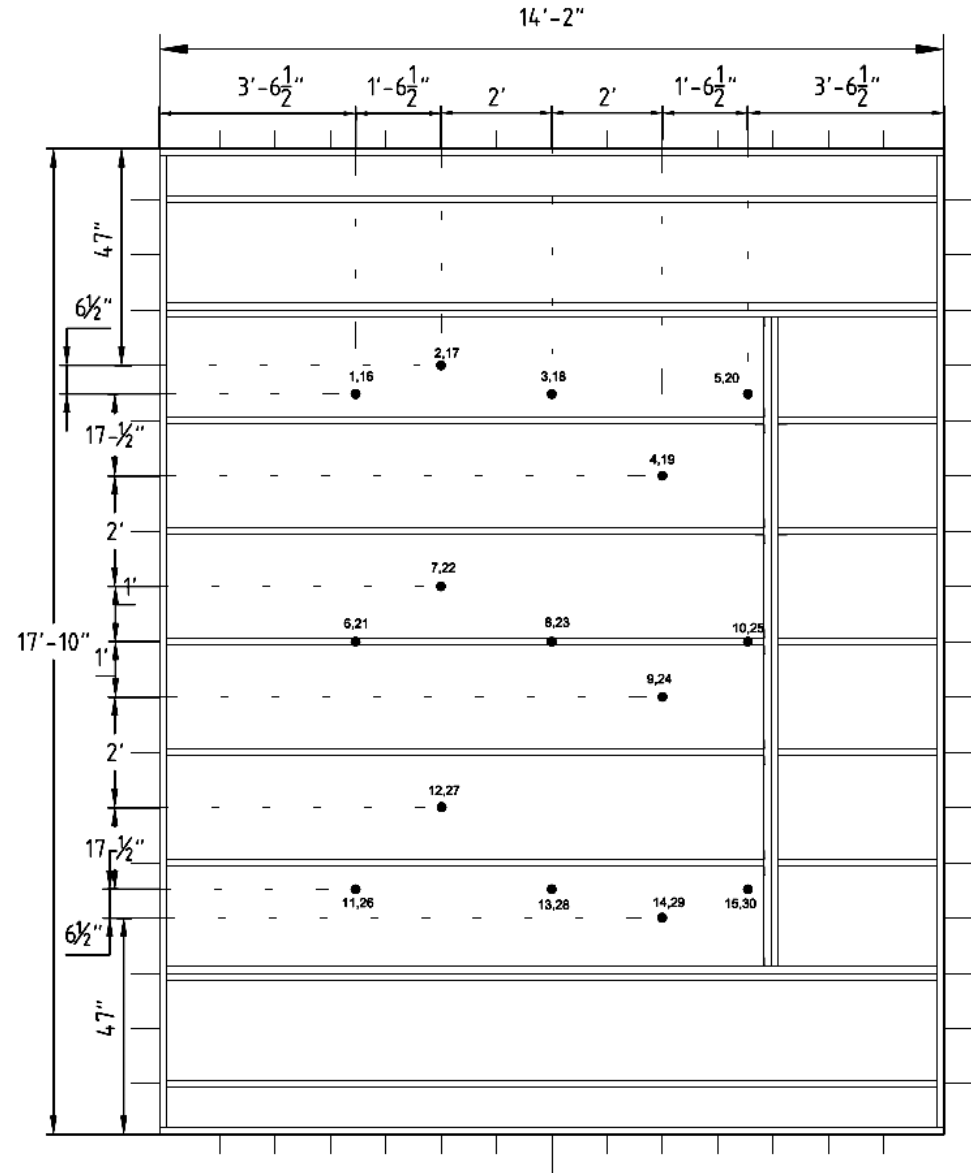

Figure A.3.4 – Thermocouple Locations on Wood Member and Bottom of Subfloor.

Assembly No. 3



T.C. Nos. 1-15 on subfloor
T.C. Nos. 16-30 on carpet padding

Figure A.3.5 – Thermocouple Locations on Subfloor and on Carpet Padding.

Assembly No. 3

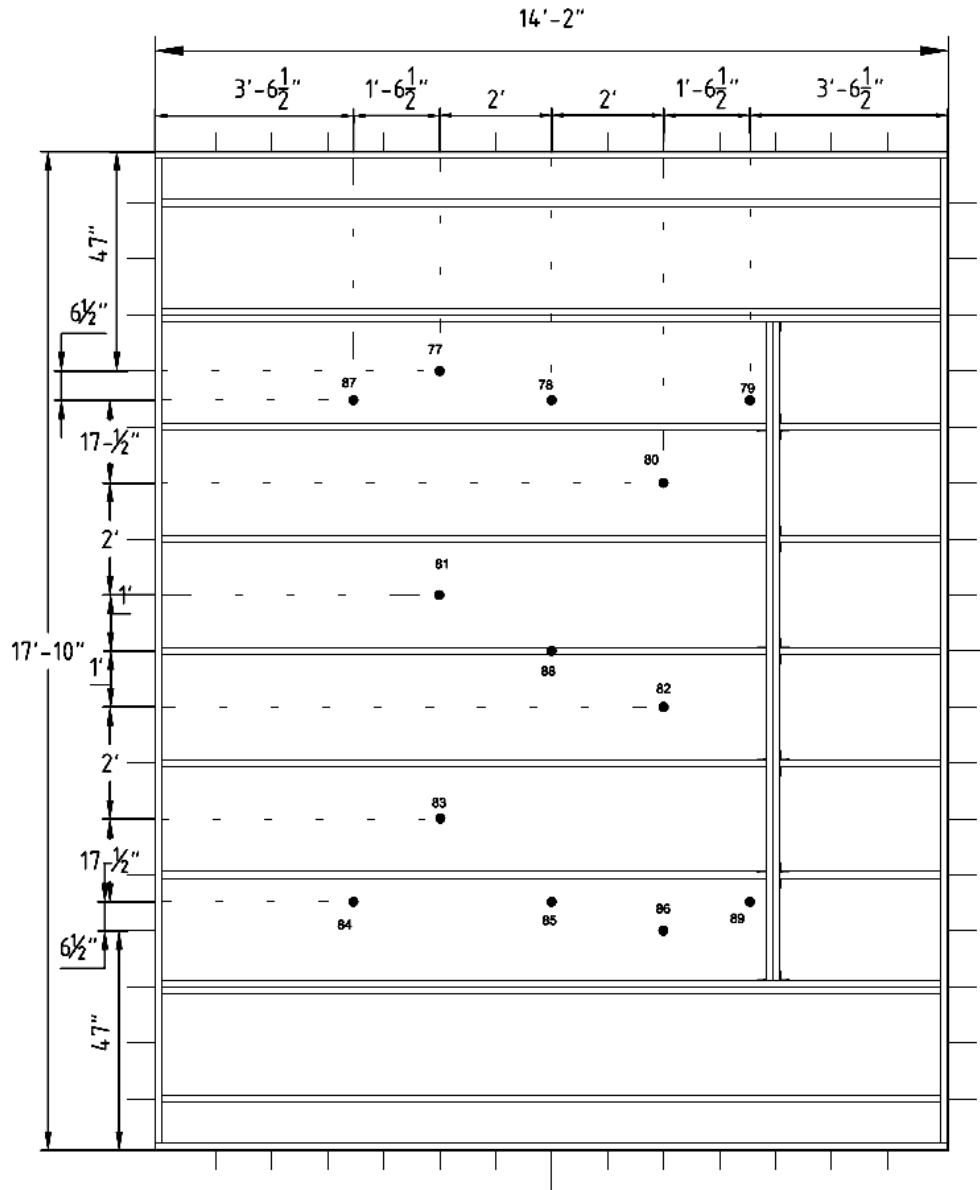
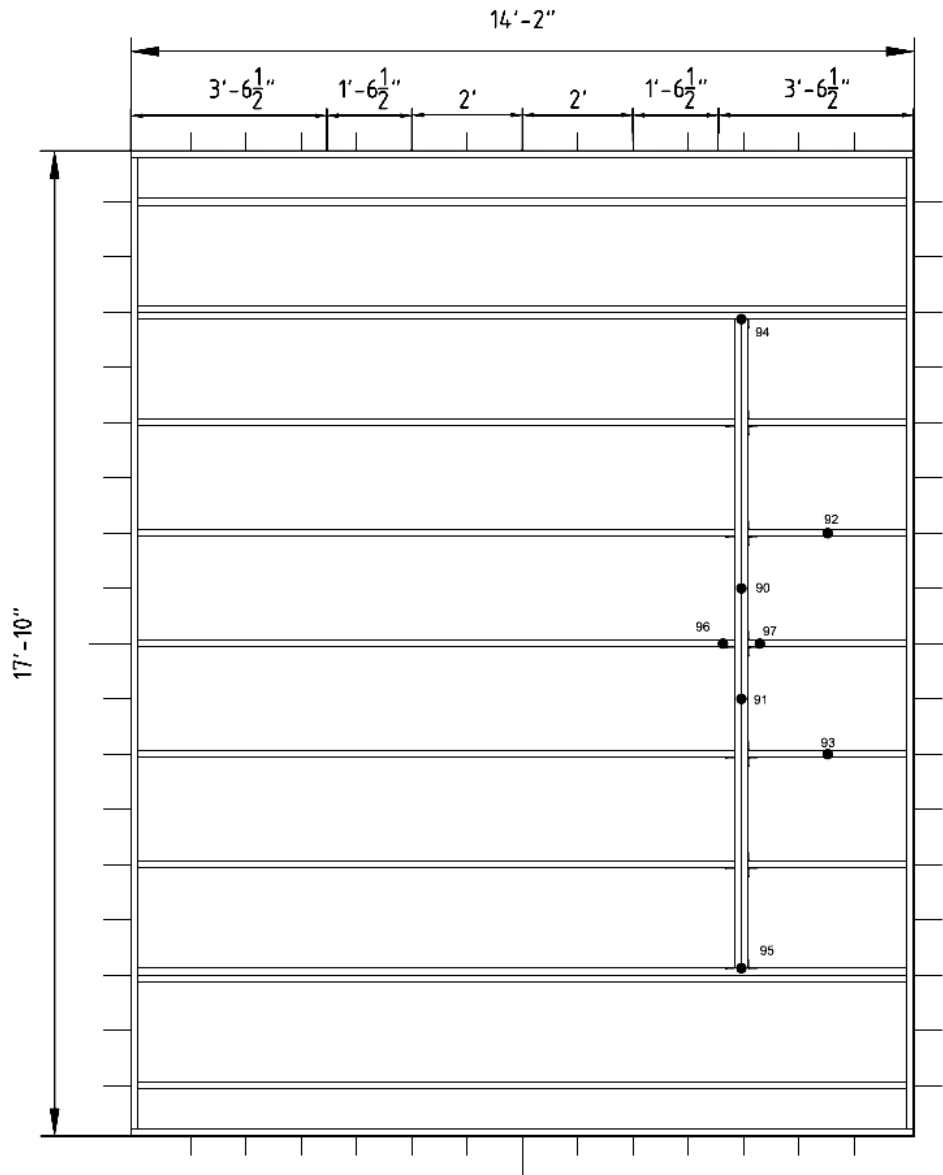

Figure A.3.6 – Thermocouple Locations on Unexposed Surface.

Assembly No. 3



Mis Structural Thermocouple Locations

90-91 On bottom of LVL Header 92-93 On bottom of Engineered I-Joist
94-97 On bottom of metal hangers.

Figure A.3.7 –Thermocouple Locations on LVL Assembly and Metal Connectors.

Assembly No. 3

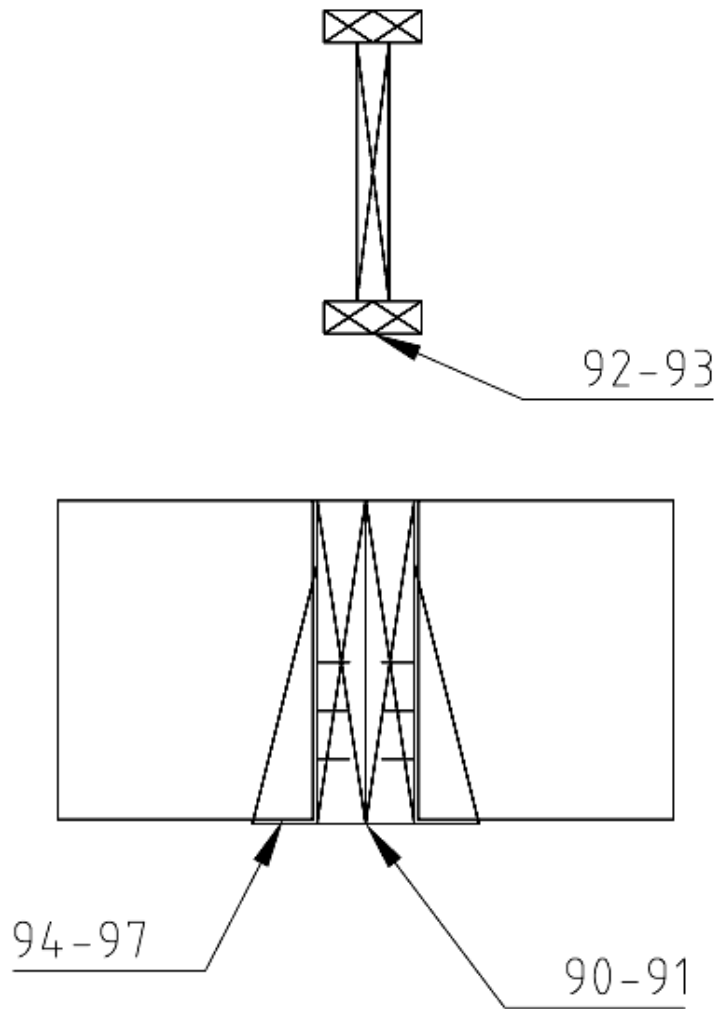

Figure A.3.8 – Elevation of Thermocouple Locations on LVL Assembly and Metal Connectors.

Assembly No. 3

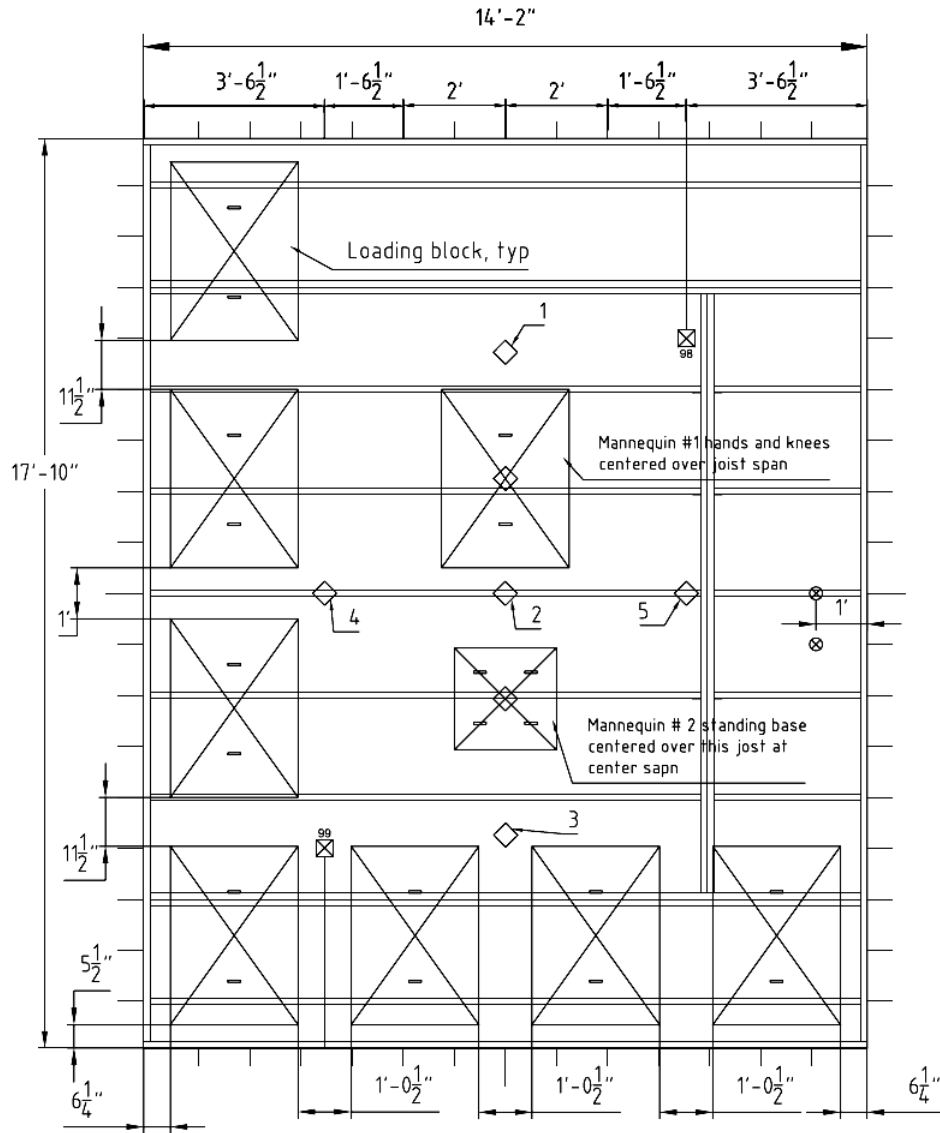

Figure A.3.9 – Loading and Instrumentation Layout (See Figure A.3.10).

Assembly No. 3**Thermocouples:**

Thermocouple No. 98 - Plate Thermocouple Centered Between Joist Along Quarter-point, Bottom Surface of Plate Thmermocouple 100 mm From Bottom Surface of Flooring.

Thermocouple No. 99 - Plate Thermocouple Centered Between Joist Along Quarter-point, Bottom Surface of Plate Thmermocouple 100 mm From Bottom Surface of Flooring.

Deflection Transducers:

- 1 - Along E-W Centerline, North Quarter-point.
- 2 - Along E-W Centerline, Center-point.
- 3 - Along E-W Centerline, South Quarter-point.
- 4 - Along N-S Centerline, West Quarter-point.
- 5 - Along N-S Centerline, East Quarter-point.

Accelerometers:

- 1- Over Joist, 12 in. from East edge of assembly.
- 2- Over Center of Span, 12 in. from East edge of assembly.

Audio Recordings: (Not Shown)

- 1 - Mannequin No. 1 (Hands & Knees)
- 2 - Mannequin No. 2 (Standing)

Video Camera Recordings: (Not Shown)

- Channel 1409 - floor level view from northeast corner
- Channel 1411 - IR camera from curing cell roof east center
- Channel 1412 - furnace camera from northwest corner
- Channel 1416 - overhead from east center of assembly
- Channel 1413 - overhead from south center of assembly
- Channel 1503 - overhead from west center of assembly

Furnace Pressure Probes: (Not Shown)

- 1 - located near plate thermocouple No. 98
- 2 - located near plate thermocouple No. 99

Oxygen Content : (Not Shown)

located in E exhaust duct.

Figure A.3.10 – Loading and Instrumentation Key