



**Report
on
Structural Stability of Engineered Lumber in Fire Conditions**

**Project Number: 07CA42520
File Number: NC9140**

**Underwriters Laboratories Inc.
333 Pfingsten Road, Northbrook, IL 60062**

September 30, 2008

Prepared by:

Mark S. Izydorek
Lead Engineering Associate
Fire Protection Division

Patrick A. Zeeveld, P.E.
Senior Project Engineer
Fire Protection Division

Matthew D. Samuels
Associate Project Engineer
Fire Protection Division

James P. Smyser
Associate Project Engineer
Fire Protection Division

Reviewed by:

Robert M. Berhinig, P.E.
Primary Designated Engineer
Fire Resistive Construction

Underwriters Laboratories Inc. (UL) its trustees, employees, sponsors, and contractors, make no warranties, express or implied, nor assume and expressly disclaim any legal liability or responsibility to any person for any loss or damage arising out of or in connection with the interpretation, application, or use of or inability to use, any information, data, apparatus, product, or process disclosed in this Report. This Report cannot be modified or reproduced, in part, without the prior written permission of Underwriters Laboratories Inc.

Acknowledgements

Underwriters Laboratories Inc. is grateful to Department of Homeland Security for funding this research under the Fire Prevention and Safety Grants.

Underwriters Laboratories Inc. also acknowledges the guidance and assistance provided by Chicago Fire Department, International Association of Fire Chiefs, and Michigan State University to develop the technical plan, design experiments, and analyze the results. In addition, these organizations also contributed significantly to the dissemination of the results to fire service and other safety organizations in the USA.

Executive Summary

This report describes the fire resistive performance of nine assemblies tested as part of a fire research and education grant sponsored by the Fire Prevention and Safety Grants under the direction of the Department of Home Security/Federal Emergency Management Agency/Assistance to Firefighters Grants.

Introduction

For over 35 years repeated concern has been expressed within the fire service community regarding the structural performance of wood "I" beams and 2 by 4 wood trusses commonly known as lightweight wood construction during a fire as compared to the former traditional construction of 2 by 10s supporting floors and 2 by 6s supporting roofs. In October 1992, the National Fire Protection Research Foundation published a report by Mr. Kirk Grundahl titled, "National Engineered Lightweight Construction Fire Research Project – Technical Report: Literature Search & Technical Analysis". The report cited 60 articles related to the fire performance of lightweight wood construction between 1970 and 1990. Conclusions of the research project included recognition of the need for fire performance data and the need for training focusing upon the fire performance of lightweight wood construction. These identified needs remain today.

The goals of this project include both the development of fire test data and the development of training methods. This report focuses only upon the development of the fire test data. The activities related to the educational material are reported separately.

Test Plan

Nine fire tests were conducted. Seven of the samples represented floor-ceiling constructions and two samples represented roof-ceiling constructions. A goal of the project was to develop comparable fire performance data among assemblies. All assemblies were intended to represent typical residential construction. Some assemblies included construction features such as 2 by 10 floor joists and 2 by 6 roof rafters that the fire service expressed satisfactory knowledge of their structural performance based upon their experience. Other assemblies included lighter weight wood structural members such as "I" joists and trusses. Two of the assemblies did not include a ceiling, six of the assemblies included a ceiling consisting of 1/2-inch thick regular gypsum board and one assembly included a 3/4-inch thick plaster ceiling.

The nine fire tests complied with the requirements of ASTM E119 but the applied structural load was non-traditional. Typically, a uniform load is applied on the floor or roof to fully stress the supporting structural members. This load is generally higher than the minimum design load of 40 psf specified by the building code for residential construction. For the tests described in this report, the load placed on the samples was intended to represent typical conditions during a fire. A load of 40 psf was placed along two of the four edges of the floor – ceiling assemblies to represent loads around a perimeter of a room. On each sample, two 300 pound concentrated loads were placed

near the center of the sample. A mannequin, intended to simulate fire service personnel, represented each concentrated load. For the two samples that represented roof-ceiling assemblies, the two mannequins were the only live load applied on the test sample.

Standard ASTM E119, Fire Tests of Building and Construction Materials, describes a fire test method that establishes benchmark fire resistance performance between different types of building assemblies. For floor-ceiling and roof-ceiling assemblies, the standard requires a minimum 180 square foot sample prohibit the passage of flame through the sample and limit the temperature rise at specific locations as the sample while the sample supports a load and is exposed to a standardized fire. The standardized fire represents a fully developed fire within a residential or commercial structure with temperatures reaching 1000 °F at 5 minutes and 1700 °F at 60 minutes.

The construction details of the nine samples are summarized in Table E-1

Table E-1 - Summary of Test Samples

Test Assembly No.	Supports	Ceiling	Floor or Roof
1	2 by 10s @ 16 inch centers	None	1 by 6 subfloor & 1 by 4 finish floor
2	12 inch deep "I" joist @ 24 inch centers	None	23/32 inch OSB subfloor, carpet padding & carpet
3	2 by 10s @ 16 inch centers	1/2 inch regular gypsum wallboard	1 by 6 subfloor & 1 by 4 finish floor
4	12 inch deep "I" joist @ 24 inch centers	1/2 inch regular gypsum wallboard	23/32 inch OSB subfloor, carpet padding & carpet
5	Parallel chord truss with steel gusset plate connections, 14 inch deep @ 24 inch centers	1/2 inch regular gypsum wallboard	23/32 inch OSB subfloor, carpet padding & carpet
6	Parallel chord truss with glued connections, 14 inch deep @ 24 inch centers	1/2 inch regular gypsum wallboard	23/32 inch OSB subfloor, carpet padding & carpet
7	2 by 6s @ 16 inch centers with 2/12 pitch	1/2 inch regular gypsum wallboard	1 by 6 roof deck covered with asphalt shingles
8	2 by 10s @ 16 inch centers	3/4 inch plaster	1 by 6 subfloor & 1 by 4 finish floor
9	Roof truss with steel gusset plate	1/2 inch regular gypsum wallboard	7/16 inch OSB covered with asphalt shingles

Test Assembly No.	Supports	Ceiling	Floor or Roof
	connections @ 24 inch centers with 2/12 pitch		

Test Results

The results of the ASTM E119 fire tests are expressed in terms of hours such as 1/2 hour, 1 hour or 2 hour rated assemblies. These time ratings are not intended to convey the actual time a specific structure will withstand a fire. All fires are different. Variations result from room size, combustible content and ventilation conditions. The ASTM E119 test method does provide a benchmark that enables a comparison of fire performance between test samples.

For unrestrained floor-ceiling assemblies and unrestrained roof-ceiling assemblies such as the tested samples, ASTM E119 includes the following Conditions of Acceptance:

The sample shall support the applied load without developing conditions that would result in flaming of cotton waste place on the floor or roof surface.

Any temperature measured on the surface of the floor or roof shall not increase more than 325 °F and the average temperature measured on the surface of the floor or roof shall not increase more than 250 °F.

The results of the nine fire tests in terms of the ASTM E119 Conditions of Acceptance are summarized in Table E-2.

Table E-2 - Summary of Test Results ASTM E119

Test Assembly No.	Time of 250°F avg. temperature rise on surface of floor / roof (min:sec)	Time of 325°F max. temperature rise on surface of floor / roof (min:sec)	Flame passage through floor / roof (min:sec)	Collapse (min:sec)	Fire resistance rating (min)
1	*	*	18:30	18:45	19
2	*	*	06:00	06:03	6
3	*	*	44:15	44:45	44
4	*	*	*	26:45	27
5	*	29:15	28:40	29:15	29
6	*	24:15	26:00	26:45	24
7	39:45	38:30	26:00	40:00	26

Test Assembly No.	Time of 250°F avg. temperature rise on surface of floor / roof (min:sec)	Time of 325°F max. temperature rise on surface of floor / roof (min:sec)	Flame passage through floor / roof (min:sec)	Collapse (min:sec)	Fire resistance rating (min)
8	*	*	*	79:45	51**
9	*	*	*	23:15	23

Notes:

* - This condition was not achieved during the fire test.

** - Plaster ceiling in contact with furnace thermocouples at 51 minutes. The test method requires that the junction of the thermocouples in the furnace be placed 12 inches away from the ceiling surface at the beginning of the test and shall not touch the sample as a result of deflection.

In addition to the fire resistance rating determined by the Conditions of Acceptance in ASTM E119, a finish rating is typically published for fire resistive assemblies with combustible supports such as the tested as samples. The finished rating is defined as the time when the first occurrence of either: (1) a temperature measured on the face of the combustible supports nearest to the fire increases more than 325 °F or (2) the average temperature measured on the face of the combustible supports nearest the fire increases more than 250 °F.

Several fire test standards similar to ASTM E119 such as ISO 834:1 Fire-resistance tests – Elements of building construction – Part 1: General requirements define load bearing capacity as the elapsed time that a test sample is able to maintain its ability to support the applied load during the fire test. The ability to support the applied load is determined when both:

(1) Deflection exceeds: $\frac{L^2}{400d}$; and

(2) When the deflection exceeds $\frac{L}{30}$, the Rate of Deflection exceeds: $\frac{L^2}{9000d}$

where L is the clear span measured in millimeters and d is the distance from the extreme fiber of the design compression zone to the extreme fiber of the design tensile zone of the structural element as measured in millimeters.

Other significant data obtained during the fire tests included observation of the conditions of the ceiling and floor or roof surfaces, temperatures in the concealed space above the ceiling membrane and deflections of the floor and roof surfaces.

Other significant events that occurred during the nine fire tests are summarized in Table E-3

Table E-3 - Summary of Significant Events in Addition to ASTM E119 Conditions of Acceptance

Test Assembly No.	Initial falling of ceiling material (More than 1 ft ²) (min:sec)	Average temperature on unexposed surface of ceiling at initial falling (°F)	Finish rating (min:sec)	Load bearing capacity (min)
1	No ceiling	No ceiling	00:45	18
2	No ceiling	No ceiling	00:30	4
3	23:30	605	15:30	45
4	17:15	531	7:45	25
5	16:30	519	10:45	24
6	16:00	559	12:15	25
7	15:45	253	15:15	40
8	74:00**	1109	74:00**	80
9	13:45	730	14:45	24

Notes:

** - plaster ceiling in contact with furnace thermocouples at 51 minutes

Research Findings

- The following summarizes the key findings documented in this report:
- The fire containment performance of a combustibile floor-ceiling assembly representing typical legacy construction without a ceiling was 18 minutes. The time duration was based upon the performance of the assembly when exposed to the time-temperature curve defined in Standard ASTM E119. This performance was defined as the bench mark performance for comparison purposes.
- The fire containment performance of a combustibile floor-ceiling assembly supported by engineered I joists was 14 minutes less than the bench mark performance.
- The fire containment performance of the combustibile floor-ceiling assembly supported by engineered I joists with a ½ inch thick regular gypsum board ceiling exceeded the benchmark performance by 7 minutes.

- The fire containment performance of a combustible floor-ceiling assembly supported by either: (1) engineered I joists, (2) parallel chord trusses with steel gusset plate connections or (3) parallel chord trusses with glued connections were approximately equal when a ceiling consisting of ½ inch thick regular gypsum wallboard was provided.

TABLE OF CONTENTS

ACKNOWLEDGEMENTS 2

EXECUTIVE SUMMARY 3

 INTRODUCTION 3

 TEST PLAN 3

 TEST RESULTS 5

 RESEARCH FINDINGS 7

LIST OF FIGURES 11

LIST OF TABLES 14

GENERAL 15

 TEST ASSEMBLY MATERIALS 15

Material 15

Assembly Number 15

 FIRE ENDURANCE TEST 16

Test Method 16

 TEST RECORD NO. 1 19

Materials 19

Erection of Test Assembly No. 1 19

Test Sample 19

Test Method 20

Results 20

Surface 21

Observations 21

 TEST RECORD NO. 2 25

Materials 25

Erection of Test Assembly 25

Test Sample 25

Method 26

Results 26

 TEST RECORD NO. 3 32

Materials 32

Erection of Test Assembly 32

Sample 33

Method 33

Results 33

 TEST RECORD NO. 4 41

Materials 41

Erection of Test Assembly 41

Sample 42

Method 42

Results 43

 TEST RECORD NO. 5 50

Materials 50

Erection of Test Assembly..... 50
Sample..... 51
Method 51
Results..... 52
TEST RECORD NO. 6 59
Materials..... 59
Erection of Test Assembly..... 59
Sample..... 60
Method 60
Results..... 61
TEST RECORD NO. 7 68
Materials..... 68
Erection of Test Assembly..... 68
Sample..... 69
Method 69
Results..... 70
TEST RECORD NO. 8 78
Materials..... 78
Erection of Test Assembly..... 78
Sample..... 79
Method 79
Results..... 80
TEST RECORD NO. 9 87
Materials..... 87
Erection of Test Assembly..... 87
Sample..... 88
Method 88
Results..... 89
DISCUSSION 96
Furnace Conditions 96
Floor and Roof Surface Temperature Conditions 98
Structural Serviceability 103
SUMMARY OF FINDINGS 104
Appendix A – Location of Instrumentation 106
General 106

List of Figures

Figure 1 - UL263 Standard Time Temperature Curve and Average Furnace Temperature vs. Time for Assembly No. 1 21

Figure 2 - Plot of Temperatures Below Subfloor vs. Time for Assembly No. 1 22

Figure 3 - Plot of the Subfloor Temperatures vs. Time for Assembly No. 1..... 23

Figure 4 - Plot of the Unexposed Surface Temperatures vs. Time for Assembly No. 1 .. 24

Figure 5 - Plot of Deflections vs. Time for Assembly No. 1 24

Figure 6 – UL263 Standard Time Temperature Curve and Average Furnace Temperature vs. Time for Assembly No. 2..... 27

Figure 7 - Furnace Pressure vs. Time for Assembly No. 2..... 27

Figure 8 - Oxygen Content vs. Time Oxygen Content vs. Time for Assembly No. 2..... 28

Figure 9 - Plot of Temperatures Below Subfloor vs. Time for Assembly No. 2 29

Figure 10 - Plot of the Subfloor Temperatures vs. Time for Assembly No. 2..... 30

Figure 11 - Plot of Temperature of the Carpet Padding vs. Time for Assembly No. 2.... 30

Figure 12 - Plot of Unexposed Surface Temperatures vs. Time for Assembly No. 2 31

Figure 13 - Plot of Deflections vs. Time for Assembly No. 2..... 31

Figure 14 - UL263 Standard Time Temperature Curve and Average Furnace Temperature vs. Time for Test Assembly No. 3 34

Figure 15 - Furnace Pressure vs. Time for Test Assembly No. 3..... 34

Figure 16 - Oxygen Content vs. Time for Test Assembly No. 3..... 35

Figure 17 - Plot of Temperature Below Subfloor vs. Time for Assembly No. 3..... 38

Figure 18 - Plot of Temperature of the Unexposed Surface of Gypsum Board vs. Time for Assembly No. 3..... 39

Figure 19 - Plot of Temperature of the Subfloor Temperatures vs. Time for Assembly No. 3..... 39

Figure 20 - Plot of Temperatures of the Unexposed Surface vs. Time for Assembly No. 3 40

Figure 21 - Plot of Deflections vs. Time for Assembly No. 3..... 40

Figure 22 - UL263 Standard Time Temperature Curve and Average Furnace Temperature vs. Time for Assembly No. 4..... 43

Figure 23 – Furnace Pressure vs. Time for Assembly No. 4..... 44

Figure 24 - Oxygen Content vs. Time for Assembly No. 4..... 44

Figure 25 - Plot of Temperatures Below Subfloor vs. Time for Assembly No. 4..... 46

Figure 26 - Plot of Temperature of the Unexposed Surface of Gypsum Board vs. Time for Assembly No. 4..... 47

Figure 27 - Plot of Temperature of the Subfloor Temperatures vs. Time 47

Figure 28 - Plot of Temperature of the Carpet Padding vs. Time for Assembly No. 4.... 48

Figure 29 - Plot of Temperature of the Unexposed Surface vs. Time for Assembly No. 4 48

Figure 30 - Plot of Deflections vs. Time for Assembly No. 4..... 49

Figure 31 - UL263 Standard Time Temperature Curve and Average Furnace Temperature vs. Time for Assembly No. 5 52

Figure 32 - Furnace Pressure vs. Time for Assembly No. 5..... 53

Figure 33 - Oxygen Content vs. Time for Assembly No. 5..... 53

Figure 34 - Plot of Temperature of the Average Interstitial Space vs. Time for Assembly No. 5.....	55
Figure 35 - Plot of Temperature of the Top and Bottom Metal Gusset Plates vs. Time for Assembly No. 5.....	56
Figure 36 - Plot of Temperature of the Unexposed Surface of Gypsum Board vs. Time for Assembly No. 5.....	56
Figure 37 - Plot of Temperature of the Subfloor Temperatures vs. Time for Assembly No. 5.....	57
Figure 38 - Plot of Temperature of the Carpet Padding vs. Time for Assembly No. 5....	57
Figure 39 - Plot of Temperatures of the Unexposed Surface vs. Time for Assembly No. 5.....	58
Figure 40 - Plot of Deflections vs. Time for Assembly No. 5.....	58
Figure 41 - UL263 Standard Time Temperature Curve and Average Furnace Temperature vs. Time for Assembly No. 6.....	61
Figure 42 - Furnace Pressure vs. Time for Assembly No. 6.....	62
Figure 43 - Oxygen Content vs. Time for Assembly No. 6.....	62
Figure 44 - Plot of Temperatures of Below Subfloor vs. Time	64
Figure 45 - Plot of Temperature of the Top and Bottom Glued Finger Joints vs. Time for Assembly No. 6.....	65
Figure 46 - Plot of Temperature of the Unexposed Surface of Gypsum Board vs. Time for Test Assembly No. 6.....	65
Figure 47 - Plot of Temperature of the Subfloor Temperatures vs. Time for Test Assembly No. 6.....	66
Figure 48 - Plot of Temperature of the Carpet Padding vs. Time for Test Assembly No. 6.....	66
Figure 49 - Plot of Temperatures of the Unexposed Surface vs. Time for Test Assembly No. 6.....	67
Figure 50 - Plot of Deflections vs. Time for Test Assembly No. 6.....	67
Figure 51 - UL263 Standard Time Temperature Curve and Average Furnace Temperature vs. Time for Assembly No. 7.....	71
Figure 52 - Furnace Pressure vs. Time for Assembly No. 7	71
Figure 53 - Oxygen Content vs. Time for Test Assembly No. 7	72
Figure 54 - Plot of Temperatures Below Subfloor vs. Time for Test Assembly No. 7 ...	74
Figure 55 - Plot of Temperature of the Unexposed Surface of Gypsum Board vs. Time for Test Assembly No. 7	75
Figure 56 - Plot of the Roof Deck Temperatures vs. Time for Test Assembly No. 7.....	75
Figure 57 - Plot of Temperature of the Roofing Felt vs. Time for Test Assembly No. 7	76
Figure 58 - Plot of Temperatures of the Unexposed Surface vs. Time for Test Assembly No. 7.....	76
Figure 59 - Plot of Temperatures of the Unexposed Surface of the Mushroom Vent vs. Time for Test Assembly No. 7.....	77
Figure 60 - Plot of Deflections vs. Time for Test Assembly No. 7	77
Figure 61 - UL263 Standard Time Temperature Curve and Average Furnace Temperature vs. Time for Test Assembly No. 8.....	80
Figure 62 - Furnace Pressure vs. Time for Test Assembly No. 8	81
Figure 63 - Oxygen Content vs. Time for Test Assembly No. 8	81

Figure 64 – Plot of Temperatures Below Subfloor vs. Time for Test Assembly No. 8 ... 84

Figure 65 – Plot of Temperature of the Back of the Metal Lath vs. Time for Test
Assembly No. 8..... 84

Figure 66 – Plot of Temperature of the Subfloor Temperatures vs. Time for Test
Assembly No. 8..... 85

Figure 67 – Plot of Temperatures of the Unexposed Surface vs. Time for Test Assembly
No. 8..... 85

Figure 68 – Plot of Deflections vs. Time for Test Assembly No. 8 86

Figure 69 – UL263 Standard Time Temperature Curve and Average Furnace
Temperature vs. Time for Test Assembly No. 9..... 90

Figure 70 – Furnace Pressure vs. Time for Test Assembly No. 9 90

Figure 71 – Oxygen Content vs. Time for Test Assembly No. 9 91

Figure 72 – Plot of Temperature Below Subfloor vs. Time 93

Figure 73 – Plot of Temperature of the Unexposed Surface of Gypsum Board vs. Time 93

Figure 74 – Plot of Temperature of the Roofing Felt vs. Time 94

Figure 75 – Plot of Temperatures of the Unexposed Surface vs. Time 95

Figure 76 – Plot of Deflections vs. Time 95

Figure 77 - Furnace Temperature 96

Figure 78 - Furnace Pressure 97

Figure 79 - Percent Oxygen in Furnace 97

Figure 80 -Test Assembly No. 1 98

Figure 81- Test Assembly No. 2..... 99

Figure 82 - Test Assembly No. 3..... 99

Figure 83 - Test Assembly No. 4..... 100

Figure 84 - Test Assembly No. 5..... 100

Figure 85 - Test Assembly No. 6..... 101

Figure 86 - Test Assembly No. 7..... 101

Figure 87 - Test Assembly No. 8..... 102

Figure 88 - Test Assembly No. 9..... 102

List of Tables

Table 1 - Identification of Materials used in Multiple Assemblies	15
Table 2 - Set Depth of Steel Angles.....	17
Table 3 - Deflection of Assembly After Application of Load.....	18
Table 4 – Observations for Test Assembly No. 1	21
Table 5 – Observations for Assembly No. 2.....	28
Table 6 - Observations for Test Assembly No. 3.....	35
Table 7 – Observations for Test Assembly No. 4.....	45
Table 8 – Observations for Assembly No. 5.....	54
Table 9 – Observations for Assembly No. 6.....	63
Table 10 - Observations for Assembly No. 7	72
Table 11 - Observations for Assembly No. 8	82
Table 12 - Observations for Assembly No. 9	91
Table 13 - Average temperature on exposed surface of sub-floor or roof deck and average temperature on unexposed surface of floor or roofing shingles.	103

General

This section describes the construction of the test assemblies, and the test results.

Test Assembly Materials

Several materials were used to construct more than one test assembly. The assemblies in which these materials were used are identified in Table 1.

Table 1 - Identification of Materials used in Multiple Assemblies

Material	Assembly Number								
	1	2	3	4	5	6	7	8	9
Joists - 2 by 10	Yes	No	Yes	No	No	No	No	Yes	No
Engineered I Joist	No	Yes	No	Yes	No	No	No	No	No
Bearing Plates – 2 by 4	No	Yes	No	Yes	No	No	Yes	No	No
Bearing Plates - 2 by 6	Yes	No	Yes	No	Yes	Yes	No	Yes	Yes
Subflooring (OSB)	No	Yes	No	Yes	Yes	Yes	No	No	No
Subflooring	Yes	No	Yes	No	No	No	No	Yes	No
Finished Flooring	Yes	No	Yes	No	No	No	No	Yes	No
Red Rosin Paper	Yes	No	Yes	No	No	No	No	Yes	No
Carpet with Padding	No	Yes	No	Yes	Yes	Yes	No	No	No
Tack Strip	No	Yes	No	Yes	Yes	Yes	No	No	No
Felt Paper - 30 lbs.	No	No	No	No	No	No	Yes	No	Yes
Class A Asphalt Shingles	No	No	No	No	No	No	Yes	No	Yes
Faced Batt Insulation	No	No	No	No	No	No	Yes	No	Yes
Gypsum Board - 1/2 in.	No	No	Yes	Yes	Yes	Yes	Yes	No	Yes

The materials used in more than one assembly are described below.

Joists – The nominal 2 in. by 10 in. dimensional lumber measured 9-1/8 in. by 1-1/2 in. cut to a length of 13 ft 10 in. and bore the marking “SPF No. 2 KD-HT.” The moisture content of the joists ranged from 11.7 to 15.4 percent and averaged 13.3 percent moisture.

Engineered I Joists – The nominal 12 in. engineered I Joist measured 11-7/8 in tall and were cut to a length of 13 ft 7-3/4 in. The chords consisted of 2 in. wide by 1-3/16 deep laminated veneer lumber. The web consisted of 3/8 in. thick oriented strand board. The average weight of the I Joists was 34.94 lbs.

Bearing Plate (2 by 4) – The nominal 2 in. by 4 in. dimensional lumber measured 1-1/2 in. by 3-1/2 in. and cut to lengths of 5 ft 8 in. and 12 ft 3/4 in. long.

Bearing Plate (2 by 6) – The nominal 2 in. by 6 in. dimensional lumber measured 1-1/2 in. by 5-1/2 in. and cut to lengths of 9 ft 6 in. and 8 ft 3-1/2 in. long.

Subflooring (OSB) – The nominal 1 in. by 6 in. tongue and groove subflooring measured 3/4 in. by 5-1/8 in. and cut to random lengths.

Finish Flooring – The nominal 1 in. by 4 in. square edged finish floor measured 3/4 in. by 3-1/4 in. and cut to random lengths.

Red Rosin Paper – Measured 36 in. wide by 0.01 in. thick. The regular weight red rosin paper was supplied in a 144 ft. long roll.

Carpet Padding – The carpet padding measured 7/16 in. thick and was supplied in 6 ft wide by 45 ft long rolls. The carpet padding weighed 0.23 lbs/ft².

Carpet – The carpet was supplied in a 14 ft 3 in. wide by 18 ft. long roll. The nominal thickness of the carpet was 1/2 in. The carpet contained no identification markings. The carpet weighed 0.43 lbs/ft².

Tack Strip – Premium carpet gripper measured 1/4 in. thick by 7/8 in. wide and 48 in. long. The pre-nailed tack lengths were 3/4 in. and were spaced approximately 5-3/4 in. apart along the strip.

Gypsum Board – The nominal 1/2 in. thick regular gypsum wallboard had tapered edges and measured an average of 8 ft long by 4 ft wide and had an average thickness of 1/2 in. thick.

Felt Paper – No. 30 asphalt felt paper weighed 0.15 lb/ft² and was supplied in 216 ft² rolls. The rolls were 36 in. wide.

Class A Asphalt Shingles – Each shingle sheet measured 1 ft by 3 ft and weighed 2.66 lbs per sheet.

Faced Batt Insulation – The R-30 paper faced insulation measured 9-1/2 in. thick by 16 in. wide by 48 in. long. Each bundle weighed approximately 23.5 lbs.

Fire Endurance Test

The fire tests were conducted in accordance with the Standard, Fire Tests of Building Construction and Materials, ANSI/UL 263 (ASTM E119), 13th Edition, April 4, 2003.

Test Method

The standard test equipment of (UL) for floor/roof and ceiling assemblies was used for the fire endurance test.

The location of instrumentation within the furnace and on the test samples is shown in Appendix A. The furnace chamber temperatures were measured with 16 thermocouples

located 12 in. below the exposed surface. A plot of the average furnace temperature verses the standard time temperature curve can be seen under the results portion of each test record.

During preparation of the test frames by UL prior to the construction of the test assembly, 4 in. by 6 in. by 3/4 in. thick steel angles were secured to the East and West edges of the test frames and set at depths specified in Table 2. The test frame was protected with vermiculite concrete poured to the top of the angles.

Table 2 - Set Depth of Steel Angles

Test Assembly Number	Angle Depth (Inch)
1	12-1/4
2	15
3	12-1/4
4	15
5	17
6	17
7	8-1/4
8	12-1/4
9	9

Assemblies 1-6 and 8 were loaded with a uniform load of 40 psf applied to the South and West edges of the assembly. The assembly was divided into quarters in the length and width and the loading was positioned over the Western and Southern quarters of the assembly. In addition to the uniform load, two 300 lb mannequins were located 24 inches North and South of the East-West centerline of the assembly, at the center of the span. One mannequin was intended to simulate a standing firefighter and the load was distributed over a four square foot base. The other mannequin was intended to simulate a crawling firefighter and the load was distributed through the hands and knees. Drawings showing the floor assembly loading are located in Appendix A.

Assemblies 7 and 9 were only loaded with the two 300 lb mannequins. The mannequins were located on the East half of the roof pitch at the center of the slope, 24 inches North and South of the East-West Centerline. Drawings showing the roof assembly loading are also located in Appendix A.

The deflection of each assembly after application of the load is shown in Table 3.

Table 3 - Deflection of Assembly After Application of Load

Test Assembly Number	Deflection (Inch)
1	0.13
2	0.25
3	0.10
4	0.09
5	0.07
6	0.08
7	Not Available
8	0.02
9	0.05

The floor ceiling and roof ceiling assemblies were installed in the test frame in accordance with standard practices and methods. The test assemblies were constructed by UL staff at UL's fire test laboratory located in Northbrook, IL.

All nine assemblies were tested in accordance with ASNI/UL263 and ASTM E119. The condition of acceptance for these standards state the transmission of heat through the specimen during the classification period shall not have raised the average temperature on its unexposed surface to more than 250°F above its initial temperature. The specimen shall have sustained the applied load during the classification period without developing unexposed surface conditions that will ignite cotton waste.

Test Record No. 1

Materials

Materials described in section General and used in Assembly No. 1 include 2 in. by 10 in. joists, 2 in. by 6 in. bearing plates, subflooring, red rosin paper and finish flooring. Additional materials are described below.

Cross Bridging – The nominal 1 in. by 3 in. dimensional lumber measured 11/16 in. by 2-7/16 in. and each end was cut at an angle and a length of 16-3/8 in.

Erection of Test Assembly No. 1

Nominal 2 in. by 6 in. structural grade wood bearing plates were placed on top of the steel angles. The 2 in. by 10 in. joists were placed on the wood bearing plates and spaced 16 in. OC starting 8 in. from the East-West centerline of the assembly. The joists were fire stopped with 14-1/2 in. long pieces of nominal 2 by 10 in. lumber. At the North and South ends of the assembly, additional joists, not in the field of the fire for the test, were placed 2-1/2 inches from the North and South edges of the assembly over the vermiculite concrete in order stabilize the nominal 1 by 4 in. tongue and groove subfloor. The average bearing at each end of the joist was 5-1/4 in. The joists were fastened to each bearing plate with two No. 16d coated sinker nails.

The joists were stabilized by nominal 1 by 3 in. bridging cut to lengths of approximately 16-1/2 in. long with their ends cut to an angle of approximately 45 degrees. The pieces of bridging was secured diagonally opposed to each other between each pair of joists with two 8d coated sinker nails at each end of each piece.

The nominal 1 by 6 in. random length tongue and groove subfloor boards were laid diagonally (45 degrees to the joists) and secured in place with No. 8d coated sinker nails four nails per butt joint and two nails in the field at each joist.

The red rosin paper was laid over the subfloor in the East-West direction and secured in place with staples in a random order. There was a 4 in. overlap of each roll of paper.

The nominal 1 by 4 in. tongue and groove finish floor was installed over the building paper and oriented perpendicular to the joists. The finish floor was secured to the joists by 2 in. FLN-200 hardwood flooring nails spaced nominally 8 in. OC nailed through the tongue and groove using an angled flooring nailer.

A bead of fire resistive caulk was placed around the perimeter of the assembly to prevent any flame through between the frame and the test sample.

Test Sample

The fire endurance test was conducted on the assembly described previously in this Report under "Erection Of Test Assembly". Test results relate only to items tested.

Test Method

The location of instrumentation within the furnace and on the test sample is shown on Figures A1.1 - A1.8 in Appendix A.

The temperatures of the nominal 2 by 10 in joists were measured with 20 thermocouples. Thermocouple numbers 16-25 were located on the bottom of joist and thermocouple numbers 26-35 were located on the side of the joist mid depth facing North. The thermocouples were stapled to the joists.

The temperatures within the interstitial space were measured with 18 thermocouples. Thermocouple numbers 36-44 were located at the center of the interstitial space mid depth, and thermocouple numbers 45-53 located at the center of the interstitial space on the bottom of the subfloor.

The temperatures between the subfloor and finish floor were measured with 15 thermocouples and numbered 1-15.

The temperatures on the unexposed surface were measured with 15 thermocouples and numbered 54-68. Each of the unexposed surface thermocouples was covered with a 6 by 6 in. dry ceramic fiber pad.

The deflection of the assembly was measured with five electronic transducers.

There were a total of eight camera views taken during the fire exposure period. One camera was positioned in the furnace recording the exposed surface of the assembly. Five other cameras recorded separate angles of the unexposed surface of the assembly and one infrared camera recorded the unexposed surface temperatures.

Results

Throughout the test, observations were made of the character of the fire, of the conditions of the exposed and unexposed surfaces, and of other events relative to the fire resistance performance of the assembly.

Character and Distribution of the Furnace Fire - The furnace fire was luminous and well distributed throughout the test. A plot of the furnace temperature can be seen on Figure 1.

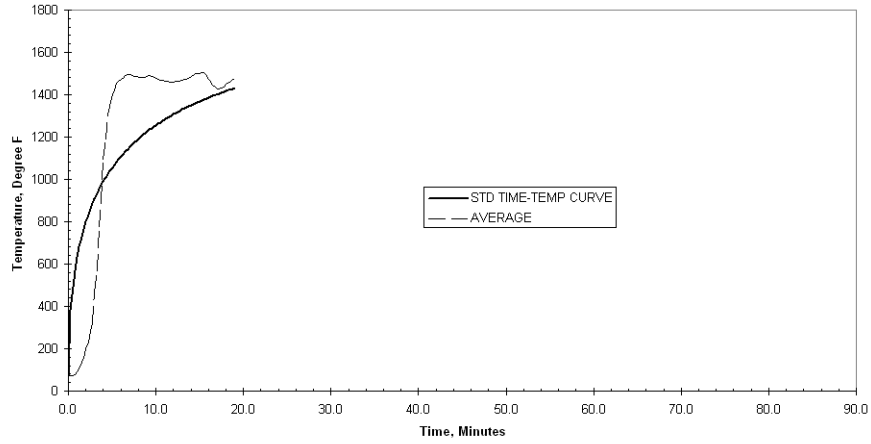

Figure 1 - UL263 Standard Time Temperature Curve and Average Furnace Temperature vs. Time for Assembly No. 1

Observations of the Exposed and Unexposed Surfaces - The observations were made during the fire test are presented in Table 4. All references to dimensions are approximate.

Table 4 – Observations for Test Assembly No. 1

Test Time, Min:Sec	Exposed (E) or Unexposed (U) Surface	Observations
1:00	E	Bottom of 2 by 10 in. joists began to char.
1:41	E	The 2 by 10 in. joists ignited.
2:05	E	The 1 by 6 in. subfloor ignited.
2:30	E	Visible observations were obscured by smoke.
2:30	U	Cracking from burning joists and subfloor could be heard.
3:00	E	Intense flaming and shaking of the assembly for about 10 seconds.
3:00	U	Microphone on standing firefighter was vibrating.
5:00	E	Still no visible observations could be seen due to excessive flames and smoke.
8:00	E	Only the furnace TCs and pylons could be seen.
9:50	E	Thought the heavy smoke and flames, sparks can be seen falling from the assembly.
13:45	U	Smoke began to emit from the joints in the hardwood floor.
18:30	U	Flame through occurred near crawling mannequin.
18:45	E	Mannequins fell through the floor assembly. Gas off.

Temperatures of the Wood Joists - The finish rating is defined as the time necessary to raise the average temperature measured on the face of the bottom surface nearest the fire 250°F or the time required to raise the temperature on the bottom surface 325°F at any point. The average temperature measured on the bottom surface of the joists was 73°F before the test. Therefore, the average limiting temperature was 323°F and the individual limiting temperature was 398°F. The average limiting temperature for the finish rating was reached at 45 seconds as recorded by the average of thermocouple numbers 16-25.

Temperatures of the Side of Mid Depth of Wood Joists – The average and maximum temperatures of the sides of the wood joists just before the moment of collapse (18 min 45 sec) were 1110°F and 1158°F respectively. The maximum individual temperature was recorded by thermocouple number 28. The average temperature was plotted on Figure 1.2.

Temperatures of the Mid Depth Between Wood Joists – The average and maximum temperatures of the mid depth between the wood joists just before the moment of collapse (18 min 45 sec) were 1114°F and 1147°F respectively. The maximum individual temperature was recorded by thermocouple number 38. The average temperature was plotted on Figure 1.2.

Temperatures of the Sub Floor Between Wood Joists – The average and maximum temperatures of the sub floor between the wood joists just before the moment of collapse (18 min 45 sec) were 1122°F and 1161°F respectively. The maximum individual temperature was recorded by thermocouple number 46. The average temperature was plotted on Figure 2.

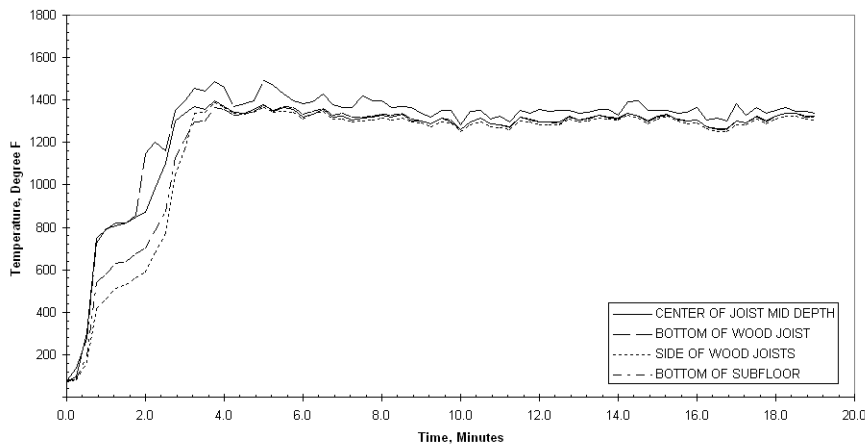

Figure 2 - Plot of Temperatures Below Subfloor vs. Time for Assembly No. 1

Temperatures of Between the Sub Floor and Finish Floor – The average and maximum temperatures between the sub floor and finish floor just before the moment of collapse (18 min 45 sec) were 383°F and 939°F respectively. The maximum individual temperature was recorded by thermocouple number 8. The average temperature was plotted on Figure 3.

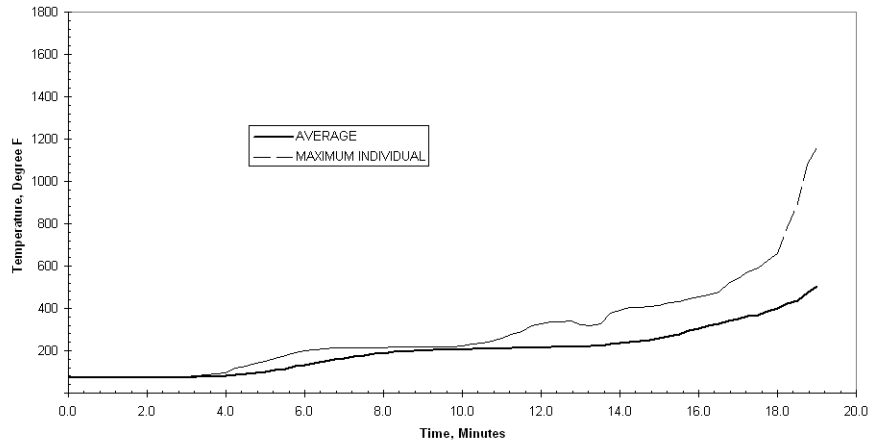

Figure 3 - Plot of the Subfloor Temperatures vs. Time for Assembly No. 1

Temperatures of the Unexposed Surface – The average and maximum temperatures of the unexposed surface just before the moment of collapse (18 min 45 sec) were 122°F and 616°F respectively. The maximum individual temperature was recorded by thermocouple number 61. The average temperature and maximum temperatures were plotted on Figure 4.

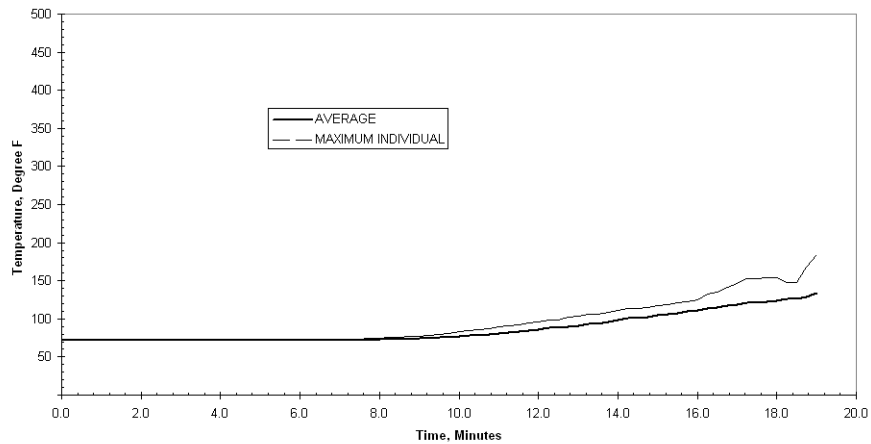

Figure 4 - Plot of the Unexposed Surface Temperatures vs. Time for Assembly No. 1

Deflection of the Assembly - The deflection of the floor-ceiling assembly during the fire test is shown on Figure 5. The location of each deflection transducer can be seen in Appendix A under Test Assembly 1.

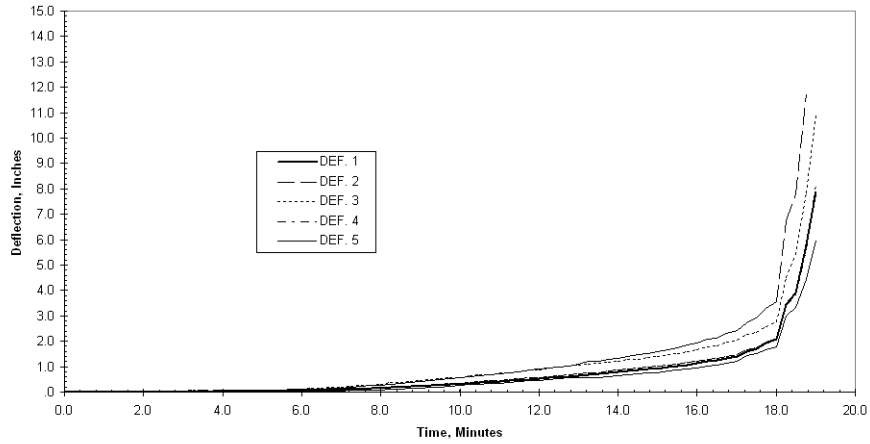

Figure 5 - Plot of Deflections vs. Time for Assembly No. 1

Test Record No. 2

Materials

Materials described in section General and used in Assembly No. 2 include engineered I Joist, 2 by 4 bearing plate, subfloor (OSB), carpet and padding, and tack strips. Additional materials are described below.

Rimboard – The nominal 1-1/8 in. by 12 in. OSB measured 1-1/8 in. thick by 11-15/16 in. wide and 144 in.

Erection of Test Assembly

Nominal 2 in. by 4 in. structural grade wood bearing plates were placed on top of the steel angles. The wood I joists were placed on the wood bearing plates and spaced 24 in. OC starting at the East-West centerline of the assembly. The joists were fire stopped with 12 ft long pieces of rimboard. At the North and South ends of the assembly, two additional wood I joists, not in the field of the fire for the test, were placed on the North and South edges of the assembly over the vermiculite concrete, of the laboratory's test frame, in order stabilize the wood tongue and groove subfloor. The average bearing at each end of the truss was 2-1/4 in. The trusses were fastened to each bearing plate with two No. 8d coated sinker nails spaced 12 in. OC.

The nominal 8 ft by 4 ft tongue and groove subfloor boards were laid perpendicular to the wood I joists. A 1/4 in. bead of adhesive was placed on the top flange of each wood I joist and a 1/8 in. bead of adhesive was placed on the tip of the tongue and groove connection prior to sliding the subfloor panels together and set in place. The subfloor panels were secured in place with 1-7/8 in. long ringshank underlayment nails spaced 6 in. OC at the edges of the panels and 12 in. OC in the field of each panel.

The pre-nailed tack strips were secured to the subfloor around the perimeter of the assembly approximately 2 in. from the inside edge of the test frame.

The 6 ft wide carpet padding had joints spaced 6 ft, 12 ft and 17 ft 6 in starting at the South edge of the assembly. The carpet padding was secured to the subfloor with 1/4 in. long staples spaced 18 in. OC around the perimeter of each laid piece of padding.

The 14 ft 3 in. wide by 18 ft long roll of carpet was laid on top of the carpet padding. The carpet was stretched tight and secured to the carpet gripper nailing strips located at the perimeter of the entire assembly.

Test Sample

The fire endurance test was conducted on the assembly described previously in this Report under "Erection Of Test Assembly". Test results relate only to items tested.

Method

The location of instrumentation within the furnace and on the test sample is shown on Figures A1.1 - A1.8 in Appendix A.

The temperatures of the wood I joists were measured with 20 thermocouples. Thermocouple numbers 31-40 were located on the bottom of I joist and thermocouple numbers 41-50 were located on the side of joist at mid depth facing North and stapled to the trusses.

The temperatures within the interstitial space were measured with 20 thermocouples. Thermocouple numbers 51-60 were located at the center of the interstitial space mid depth and thermocouple numbers 61-70 were located at the center of the interstitial space on the bottom of the subfloor.

The temperatures between the subfloor and carpet padding were measured with 15 thermocouples and numbered 1-15.

The temperatures on top of the carpet padding (between the carpet padding and carpet) were measured with 15 thermocouples and numbered 16-30.

The unexposed temperature were measured with 13 thermocouples and numbered 71-83. Each of the unexposed surface thermocouples was covered with a 6 by 6 in. dry ceramic fiber pad.

The deflection of the assembly was measured with five electronic transducers.

There were a total of eight camera views taken during the fire exposure period. One camera was positioned in the furnace recording the exposed surface of the assembly. Six other cameras recorded separate angles of the unexposed surface of the assembly and one infrared camera recorded the unexposed surface temperatures.

Results

Throughout the test, observations were made of the character of the fire, of the conditions of the exposed and unexposed surfaces, and of other events relative to the fire resistance performance of the assembly.

Character and Distribution of the Furnace Fire - The furnace fire was luminous and well distributed throughout the test. A plot of the furnace temperature can be seen on Figure 6.

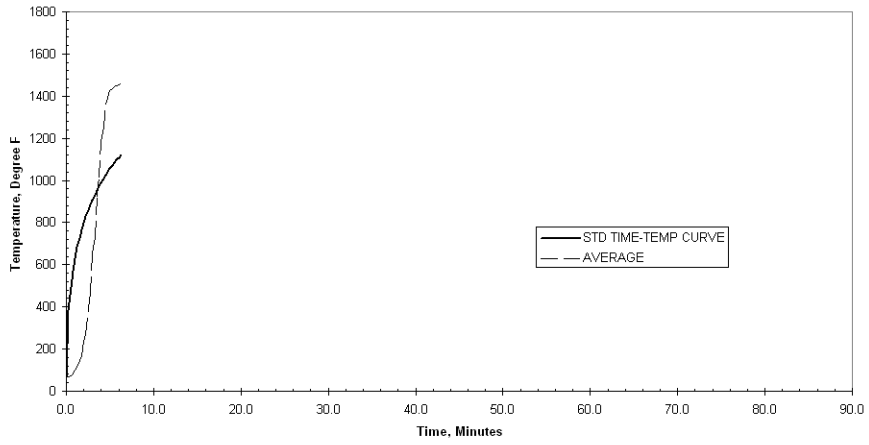

Figure 6 – UL263 Standard Time Temperature Curve and Average Furnace Temperature vs. Time for Assembly No. 2

The furnace pressure and oxygen concentration measured in the furnace are presented in Figure 7 and Figure 8.

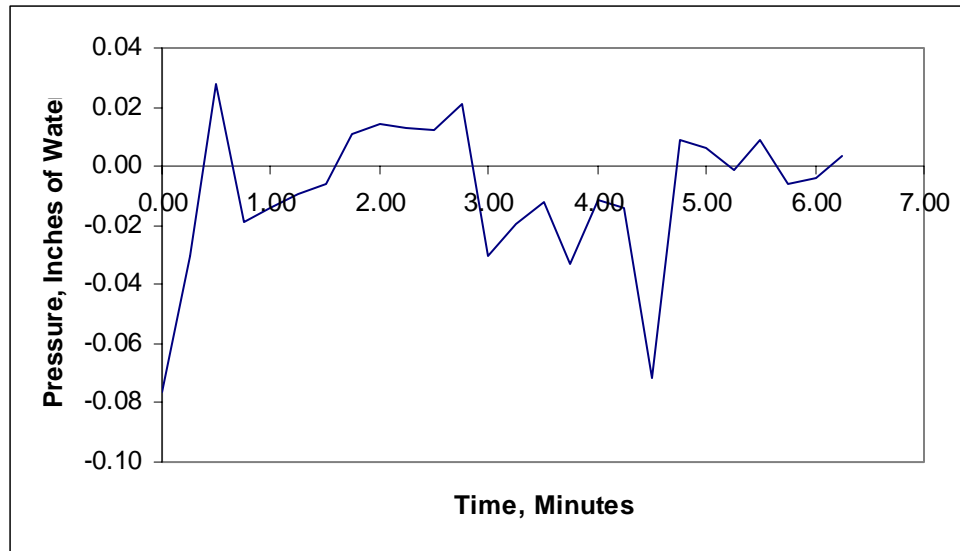

Figure 7 - Furnace Pressure vs. Time for Assembly No. 2

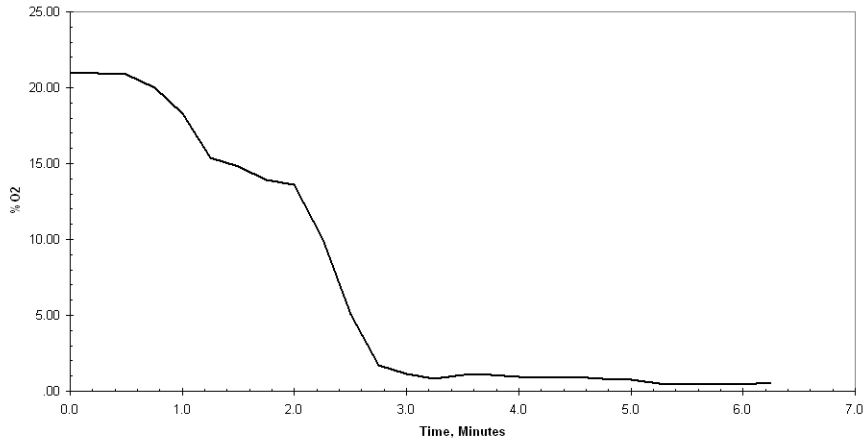

Figure 8 - Oxygen Content vs. Time Oxygen Content vs. Time for Assembly No. 2

Observations of the Exposed and Unexposed Surfaces - The following observations were made during the fire test. All references to dimensions are approximate.

Table 5 – Observations for Assembly No. 2

Test Time, Min:Sec	Exposed (E) or Unexposed (U) Surface	Observations
0:55	E	Wood members began to char.
1:00	U	No change.
1:25	E	All wood ignited.
2:00	E	All member completely engulfed in flames.
2:00	U	Smoke emitting from perimeter and smoke emitted from long plywood joints.
2:30	E	Vibrations could be felt and the furnace was sucking air from below.
2:35	U	Floor vibrating up and down.
3:15	U	Vibration continued.
3:30	E	Sucking of air continued.
4:00	U	Vibration continued and noticeable deflection about 6 inches.
4:30	U	Vibration stopped.
5:00	U	Crackling could be heard and deflection about 1-1.5 ft.
6:00	U	Flame through at South West corner of assembly.
6:03	U	Gas Off
6:03	E	Floor collapsed. Gas Off

Temperatures of the Wood I Joists - The finish rating is defined as the time necessary to raise the average temperature measured on the face of the bottom chords nearest the fire 250°F or the time required to raise the temperature on the bottom chords 325°F at any point. The average temperature measured on the bottom chords of the trusses was 73°F before the test. Therefore, the average limiting temperature was 323°F and the individual limiting temperature was 398°F.

The individual limiting temperature for the finish rating was reach at 30 seconds as recorded by thermocouple number 39.

Temperatures on the Side of Mid Depth of the Wood I Joists – The average and maximum temperatures of the sides of the wood joists just before the moment of collapse (6 min 3 sec) were 1362°F and 1486°F respectively. The individual temperature was recorded by thermocouple number 45. A plot of these temperatures can be seen on Figure 9.

Temperatures of the Mid Depth Between Wood Joists – The average and maximum temperatures of the mid depth between the wood joists just before the moment of collapse (6 min 3 sec) were 1377°F and 1430°F respectively. The individual temperature was recorded by thermocouple number 58. A plot of these temperatures can be seen on Figure 9.

Temperatures of the Sub Floor Between Wood Joists – The average and maximum temperatures of the sub floor between the wood joists just before the moment of collapse (6 min 3 sec) were 1361°F and 1417°F respectively. The individual temperature was recorded by thermocouple number 70. A plot of these temperatures can be seen on Figure 9.

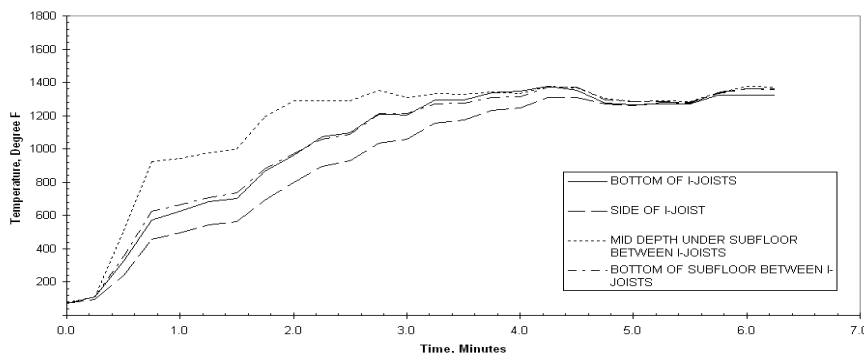

Figure 9 - Plot of Temperatures Below Subfloor vs. Time for Assembly No. 2

Temperatures of Between the Sub Floor and Carpet Padding – The average and maximum temperatures between the sub floor and finish floor just before the moment of collapse (6 min 3 sec) were 228°F and 1371°F respectively. The individual temperature

was recorded by thermocouple number 3. A plot of these temperatures can be seen on Figure 10.

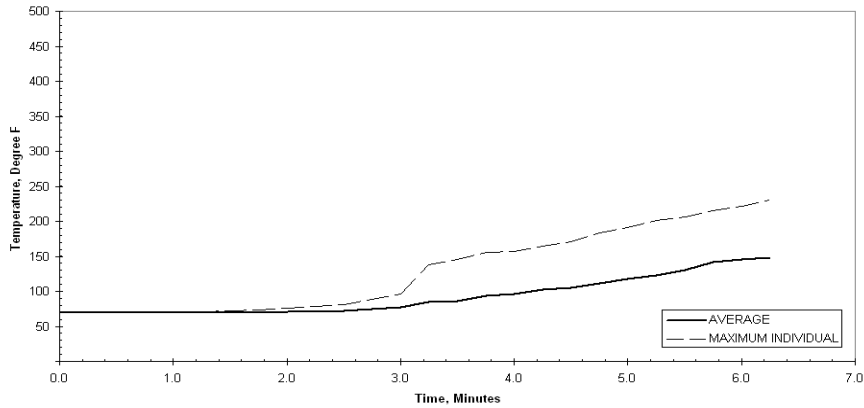

Figure 10 - Plot of the Subfloor Temperatures vs. Time for Assembly No. 2

Temperatures of Between the Carpet Padding and Carpet – The average and maximum temperatures between the carpet padding and carpet just before the moment of collapse (6 min 3 sec) were 109°F and 187°F respectively. The individual temperature was recorded by thermocouple number 29. A plot of these temperatures can be seen on Figure 11.

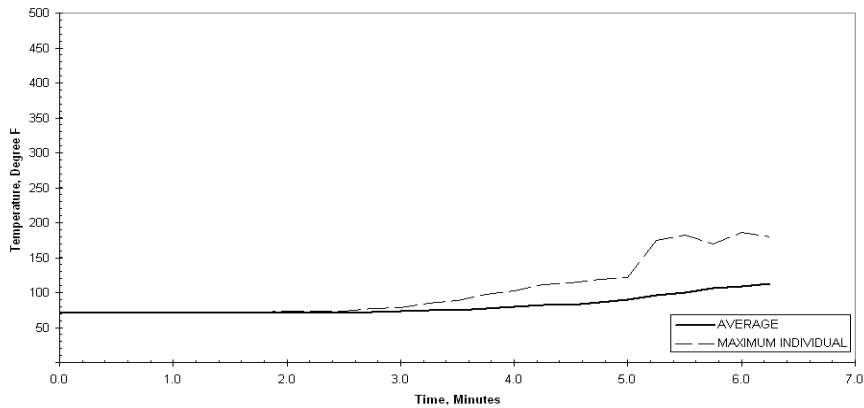

Figure 11 - Plot of Temperature of the Carpet Padding vs. Time for Assembly No. 2

Temperatures of the Unexposed Surface – The average and maximum temperatures of the unexposed surface just before the moment of collapse (6 min 3 sec) were 90°F and

114°F respectively. The individual temperature was recorded by thermocouple number 83. A plot of these temperatures can be seen on Figure 12.

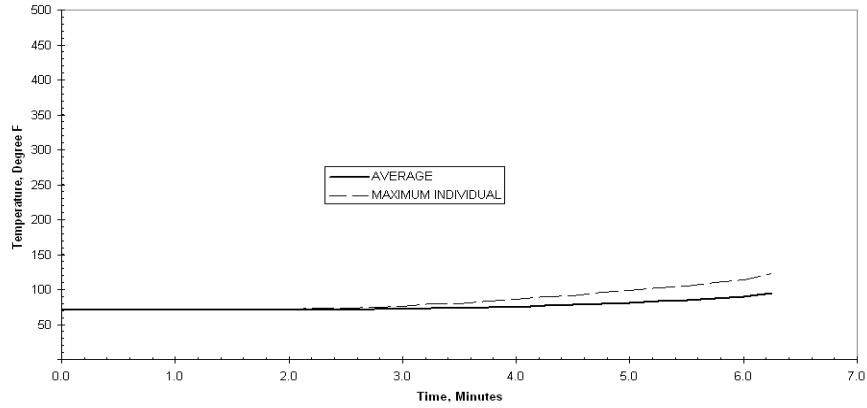

Figure 12 - Plot of Unexposed Surface Temperatures vs. Time for Assembly No. 2

Deflection of the Assembly - The deflection of the floor-ceiling assembly during the fire test is shown on Figure 13. The location of each deflection transducer can be seen in Appendix A under Test Assembly 2.

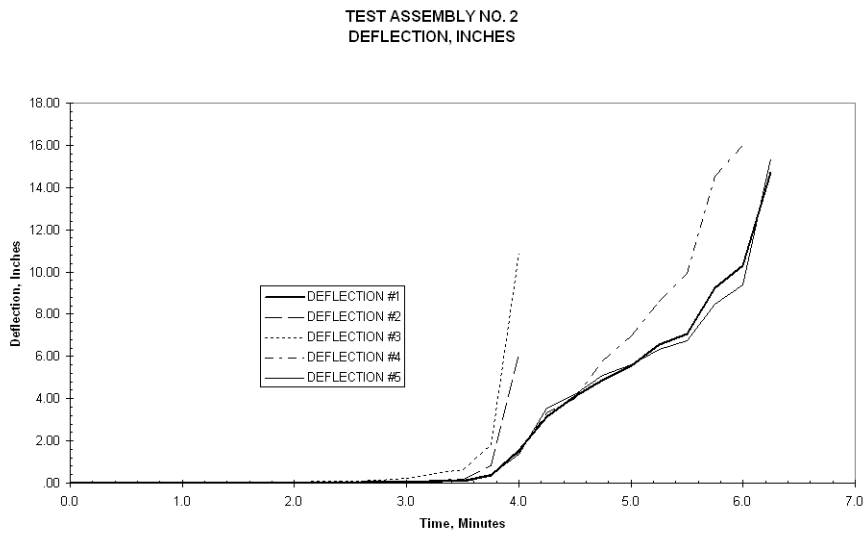

Figure 13 - Plot of Deflections vs. Time for Assembly No. 2

Test Record No. 3

Materials

Materials described in Section General and used in Assembly No. 3 include 2 in. by 10 in. joists, 2 in. by 6 in. bearing plates, subflooring, red rosin paper, finish flooring, and 1/2 in. gypsum board. Additional materials are described below.

Cross Bridging – The nominal 1 in. by 3 in. dimensional lumber measured 11/16 in. by 2-7/16 in. and each end was cut at an angle and a length of 16-3/8 in.

Erection of Test Assembly

Nominal 2 in. by 6 in. structural grade wood bearing plates were placed on top of the steel angles. The 2 in. by 10 in. joists were placed on the wood bearing plates and spaced 16 in. OC starting 8 in. from the East-West centerline of the assembly. The joists were fire stopped with 14-1/2 in. long pieces of nominal 2 by 10 in. lumber. At the North and South ends of the assembly, additional joists, not in the field of the fire for the test, were placed 2-1/2 inches from the North and South edges of the assembly over the vermiculite concrete in order stabilize the nominal 1 by 4 in. tongue and groove subfloor. The average bearing at each end of the joist was 5-1/4 in. The joists were fastened to each bearing plate with two No. 16d coated sinker nails.

The joists were stabilized by nominal 1 by 3 in. bridging cut to lengths of approximately 16-1/2 in. long with their ends cut to an angle of approximately 45 degrees. The pieces of bridging was secured diagonally opposed to each other between each pair of joists with two 6d coated sinker nails at each end of each piece.

The nominal 1 by 6 in. random length tongue and groove subfloor boards were laid diagonally (45 degrees to the joists) and secured in place with No. 8d coated sinker nails four nails per butt joint and two nails in the field at each joist.

The red rosin paper was laid over the subfloor in the East-West direction and secured in place with staples in a random order. There was a 4 in. overlap of each roll of paper.

The nominal 1 by 4 in. tongue and groove finish floor was installed over the building paper and oriented perpendicular to the joists. The finish floor was secured to the joists by 2 in. FLN-200 hardwood flooring nails spaced nominally 8 in. OC nailed through the tongue and groove using an angled flooring nailer.

A bead of fire resistive caulk was placed around the perimeter of the assembly to prevent any flame through between the frame and the test sample.

The gypsum board was secured to the exposed side of the assembly with 1-5/8 in. long phosphate coated drywall nails spaced 7 in. OC with nails spaced 1 in from the edge in the field and at the perimeter. The East-West gypsum board joints were staggered 4 ft as to not align any East-West joints. The North-South gypsum board joints were aligned and

spaced 4 ft OC. The long edges of the boards were oriented perpendicular to the joists. Two layers of dry mix joint compound was used to cover all gypsum board joints and nails heads.

Sample

The fire endurance test was conducted on the assembly described previously in this Report under "Erection Of Test Assembly". Test results relate only to items tested.

Method

The location of instrumentation within the furnace and on the test sample is shown in Appendix A.

The temperatures of the nominal 2 by 10 in joists were measured with 20 thermocouples. Thermocouple numbers 16-25 were located on the bottom of the joists and thermocouple numbers 26-35 were located on the side of joist mid depth facing North and stapled to the joists.

The temperatures within the interstitial space were measured with 18 thermocouples. Thermocouple numbers 45-53 were located at the center of the interstitial space mid depth and thermocouple numbers 54-62 were located at the center of the interstitial space on the bottom of the sub floor.

The temperatures between the subfloor and finish floor were measured with 15 thermocouples and numbered 1-15.

The temperatures on the unexposed side of the gypsum board were measured with 9 thermocouples and numbered 36-44.

The temperatures on the unexposed surface were measured with 15 thermocouples and numbered 63-77. Thermocouple number 72 malfunctioned and did not record any data. Each of the unexposed surface thermocouples was covered with a 6 by 6 in. dry ceramic fiber pad.

The deflection of the assembly was measured with five electronic transducers.

There were a total of eight camera views taken during the fire exposure period. Two cameras were positioned in the interstitial spaced in the cavities under both the kneeling and standing mannequins, both cameras were facing West. One camera was positioned in the furnace recording the exposed surface of the assembly, one infrared camera recording the unexposed surface temperatures. Four other cameras recorded separate angles of the unexposed surface of the assembly and one infrared camera recorded the unexposed surface temperatures.

Results

Throughout the test, observations were made of the character of the fire, of the conditions of the exposed and unexposed surfaces, and of other events relative to the fire resistance performance of the assembly.

Character and Distribution of the Furnace Fire - The furnace fire was luminous and well distributed throughout the test. A plot of the furnace temperature can be seen on Figure 14.

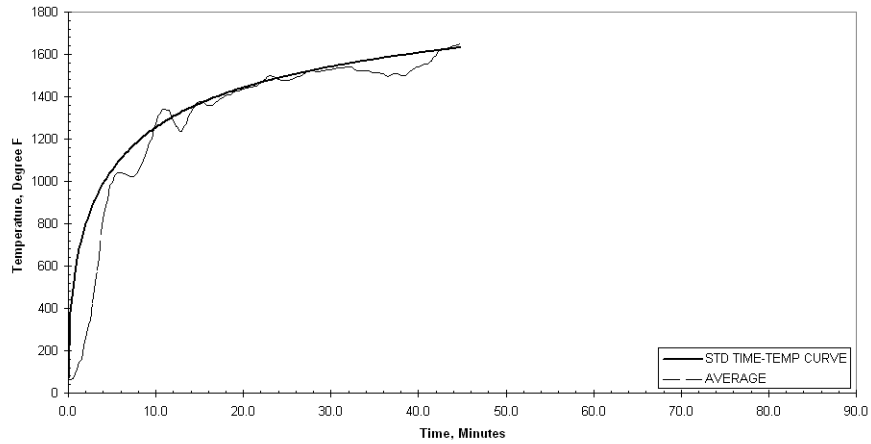

Figure 14 - UL263 Standard Time Temperature Curve and Average Furnace Temperature vs. Time for Test Assembly No. 3

The furnace pressure and oxygen concentration during the test are presented in Figure 15 and Figure 16.

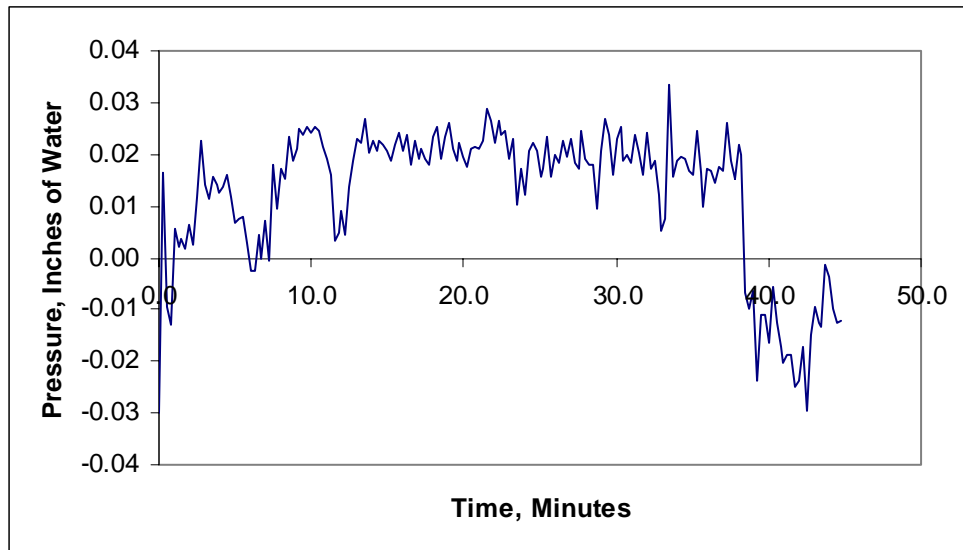

Figure 15 - Furnace Pressure vs. Time for Test Assembly No. 3

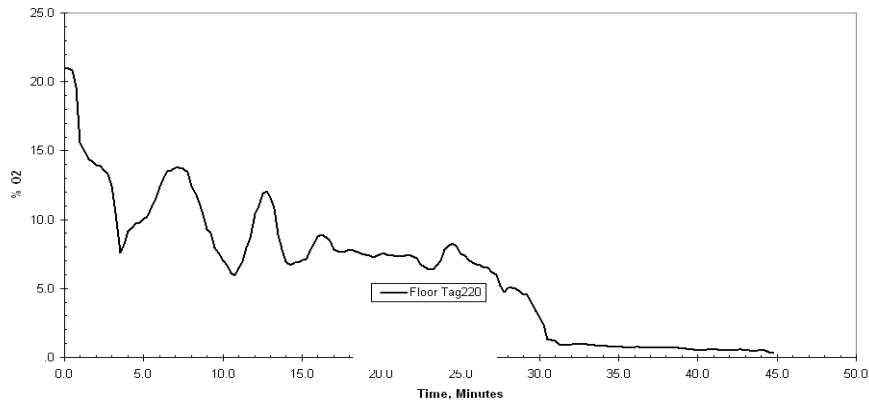

Figure 16 - Oxygen Content vs. Time for Test Assembly No. 3

Observations of the Exposed and Unexposed Surfaces - The observations made during the fire test are presented in Table 6. All references to dimensions are approximate.

Table 6 - Observations for Test Assembly No. 3

Test Time (Min:Sec)	Exposed (E) or Unexposed (U) Surface	Observations
4:00	E	Entire surface black in color.
4:00	U	No Change.
4:30	E	A very small piece of joint compound fell from a butt joint near the center of the assembly.
6:00	U	No Change.
7:00	E	Additional small areas of joint compound fell from the butt joints.
8:00	U	No Change.
10:00	E	Joint tape and compound fell from long joints.
10:00	U	No Change.
12:00	U	No Change.
12:45	E	Tape and compound continued to fall from joints and started to fall from nail heads.
14:00	E	Surface turned gray/white in color.
14:00	U	No Change.
16:00	U	No Change.

Test Time (Min:Sec)	Exposed (E) or Unexposed (U) Surface	Observations
16:30	U	Smoke emitting from perimeter at SE corner.
18:00	E	A long crack in the field of one board near the center of the assembly, 2 from South end occurred.
19:00	U	No Change.
21:00	E	Additional large crack in board near center of the assembly 10 ft from North edge of assembly occurred.
21:00	U	Smoke emitting form all saddle locations.
23:00	E	Additional large cracks opening randomly in gypsum board.
23:00	U	No Change.
23:30	E	2 ft by 4 ft piece of gypsum board fell.
23:30	U	Crackling could be heard.
24:45:00	E	1 ft by 1 ft piece of gypsum board fell.
26:00:00	E	No Change.
26:15:00	E	1 ft by 2 ft piece of gypsum board fell from south edge.
26:45:00	E	Cracking noises heard.
27:30:00	E	Additional pieces of gypsum board fell randomly.
28:00:00	U	Crackling could be heard and more intense smoke could be seen.
28:15:00	E	No visual observations could be made.
28:45:00	U	Smoke Coming through butt joints of oak flooring North Center.
30:30:00	U	Smoke coming through butt joints of oak flooring East Center.
33:00:00	U	Smoke emitting through butt joints of entire assembly.

Test Time (Min:Sec)	Exposed (E) or Unexposed (U) Surface	Observations
34:00:00	U	Crackling continued and smoke increased.
35:30:00	E	No change, still no visual observations could be made.
37:00:00	U	Smoke continued to increase
39:00:00	U	Smoke almost non-existent.
41:00:00	U	Smoke at perimeter and at floor butt joints.
41:15:00	U	Smoke emitting from pant leg of kneeling mannequin.
42:30:00	U	Pop heard. Buckling of finish flooring between concrete weight and mannequins.
44:00:00	U	Significant smoke at feet of standing mannequin.
44:15:00	U	Flame through at base of standing mannequin.
44:45:00	U	Standing mannequin fell through. Gas off.
44:45:00	E	Mannequin fell through. Gas off.

Temperatures of the Wood Joists - The finish rating is defined as the time necessary to raise the average temperature measured on the face of the bottom surface nearest the fire 250°F or the time required to raise the temperature on the bottom surface 325°F at any point. The average temperature measured on the bottom surface of the joists was 63°F before the test. Therefore, the average limiting temperature was 313°F and the individual limiting temperature was 388°F. The limiting temperature for the finish rating was reached at 15 minutes and 30 seconds as recorded by both the average of thermocouple numbers 16-25 and the individual thermocouple number 21.

Temperatures of the Side of Mid Depth of Wood Joists – The average and maximum temperatures of the sides of the wood joists just before the moment of collapse (44 min 45 sec) were 1450°F and 1550°F respectively. The individual temperature was recorded by thermocouple number 33. A plot of these temperatures can be seen on Figure 17.

Temperatures of the Mid Depth Between Wood Joists – The average and maximum temperatures of the mid depth between the wood joists just before the moment of collapse (44 min 45 sec) were 1482°F and 1566°F respectively. The individual temperature was recorded by thermocouple number 52. A plot of these temperatures can be seen on Figure 17.

Temperatures of the Sub Floor Between Wood Joists – The average and maximum temperatures of the sub floor between the wood joists just before the moment of collapse (44 min 45 sec) were 1467°F and 1528°F respectively. The individual temperature was recorded by thermocouple number 62. A plot of these temperatures can be seen on Figure 17.

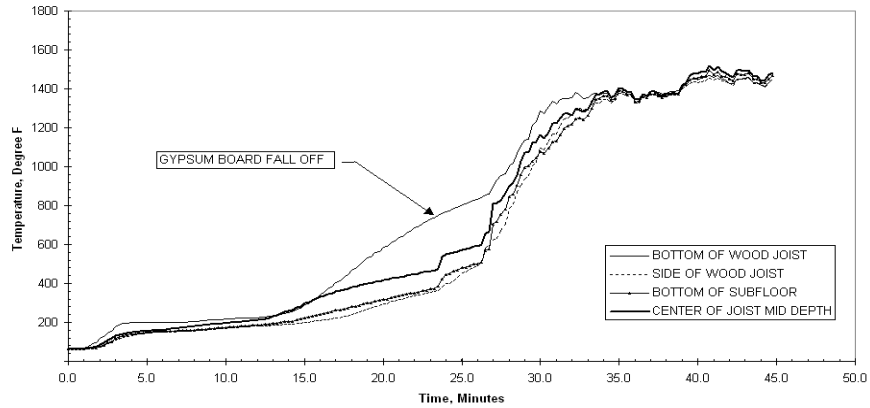

Figure 17 - Plot of Temperature Below Subfloor vs. Time for Assembly No. 3

Temperatures of the Unexposed Side of Gypsum Board - The average and maximum temperatures of the unexposed surface just before the moment of gypsum board fall off (23 min 30 sec) were 605°F and 617°F respectively. The individual temperature was recorded by thermocouple number 41. A plot of these temperatures can be seen on Figure 18.

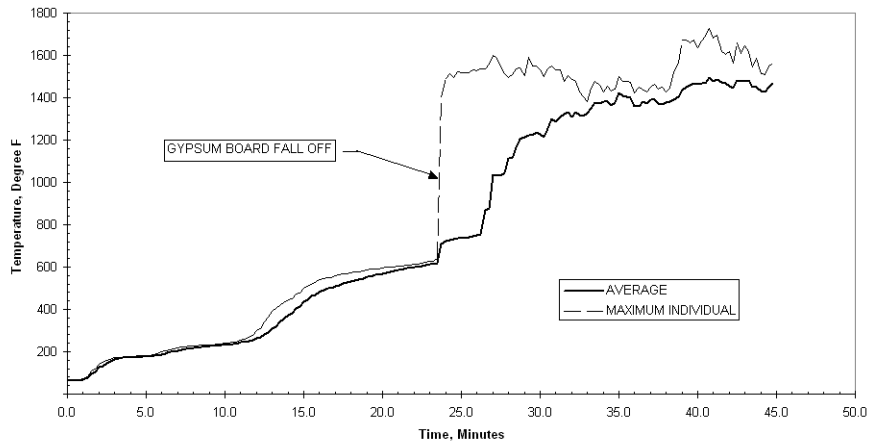

Figure 18 - Plot of Temperature of the Unexposed Surface of Gypsum Board vs. Time for Assembly No. 3

Temperatures of Between the Sub Floor and Finish Floor – The average and maximum temperatures between the sub floor and finish floor just before the moment of collapse (44 min 45 sec) were 993°F and 1479°F respectively. The individual temperature was recorded by thermocouple number 6. A plot of these temperatures can be seen on Figure 19.

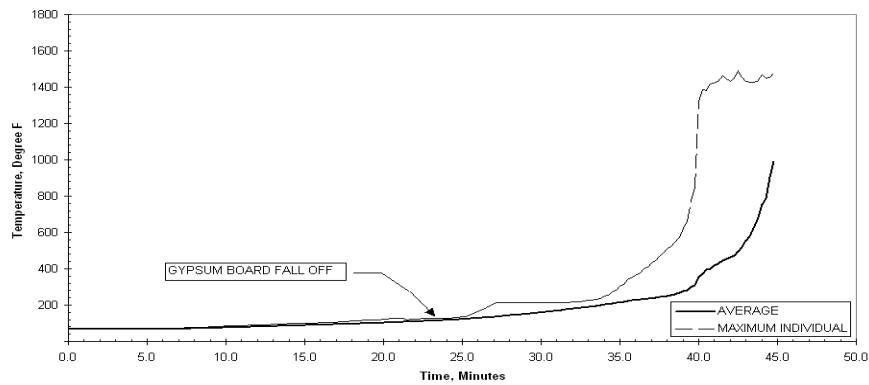

Figure 19 - Plot of Temperature of the Subfloor Temperatures vs. Time for Assembly No. 3

Temperatures of the Unexposed Surface – The average and maximum temperatures of the unexposed surface just before the moment of collapse (44 min 45 sec) were 152°F and 183°F respectively. The individual temperature was recorded by thermocouple number 77. A plot of these temperatures can be seen on Figure 20.

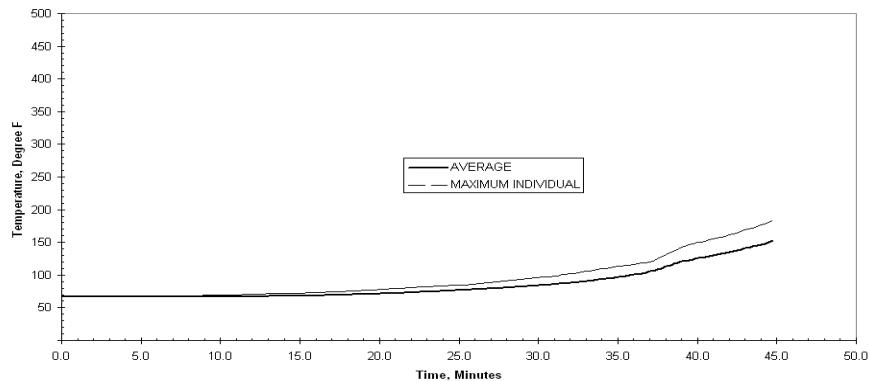
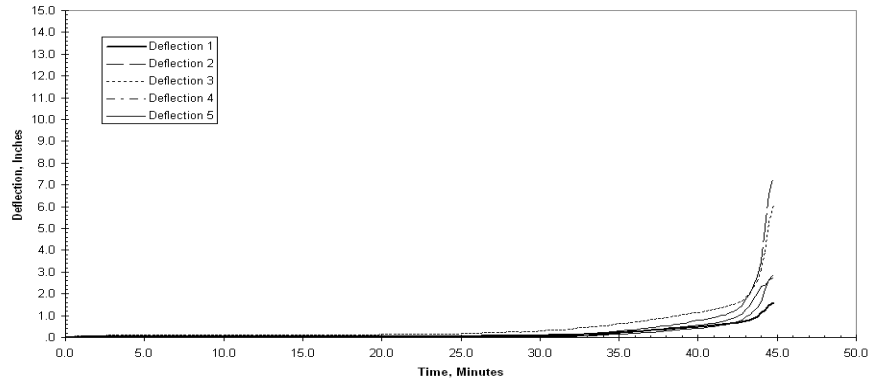

Figure 20 - Plot of Temperatures of the Unexposed Surface vs. Time for Assembly No. 3

Deflection of the Assembly - The deflection of the floor-ceiling assembly during the fire test is shown on Figure 21. The location of each deflection transducer can be seen in Appendix A under Test Assembly 3.

**Figure 21 - Plot of Deflections vs. Time for Assembly No. 3**

Test Record No. 4

Materials

Materials described in section General and used in Assembly No. 4 include engineered I Joist, 2 by 4 bearing plate, subfloor (OSB), carpet and padding, gypsum board, and tack strips. Additional materials are described below.

Rimboard – The nominal 1-1/8 in. by 12 in. OSB measured 1-1/8 in. thick by 11-15/16 in. wide and 144 in.

Erection of Test Assembly

Nominal 2 in. by 4 in. structural grade wood bearing plates were placed on top of the steel angles. The wood I joists were placed on the wood bearing plates and spaced 24 in. OC starting at the East-West centerline of the assembly. The joists were fire stopped with 144 in. long pieces of rimboard. At the North and South ends of the assembly, two additional wood I joists, not in the field of the fire for the test, were placed on the North and South edges of the assembly over the vermiculite concrete in order stabilize the wood tongue and groove subfloor. The average bearing at each end of the truss was 2-1/4 in. The trusses were fastened to each bearing plate with two No. 8d coated sinker nails spaced 12 in. OC.

The nominal 8 ft by 4 ft tongue and groove subfloor boards were laid perpendicular to the wood I joists. A 1/4 in. bead of adhesive was placed on the top flange of each wood I joist and a 1/8 in. bead of adhesive was placed on the tip of the tongue and groove connection prior to sliding the subfloor panels together and set in place. The subfloor panels were secured in place with 1-7/8 in. long ringshank underlayment nails spaced 6 in. OC at the edges of the panels and 12 in. OC in the field of each panel.

The pre-nailed tack strips were secured to the subfloor around the perimeter of the assembly approximately 2 in. from the inside edge of the test frame.

The 6 ft wide carpet padding had joints spaced 6 ft, 12 ft and 17 ft 6 in. starting at the South edge of the assembly. The carpet padding was secured to the subfloor with 1/4 in. long staples spaced 18 in. OC around the perimeter of each laid piece of padding.

The 14 ft 3 in wide by 18 ft long roll of carpet was laid on top of the carpet padding. The carpet was stretched tight and secured to the carpet gripper nailing strips located at the perimeter of the entire assembly.

The gypsum board was secured to the exposed side of the assembly with 1-5/8 in. long phosphate coated drywall nails spaced 7 in. OC with nails spaced 1 in from the edge in the field and at the perimeter. The East-West gypsum board joints were staggered 48 in. as to not align any East-West joints. The North-South gypsum board joints were aligned

and spaced 48 in. OC. The long edges of the boards were oriented perpendicular to the joists. Two layers of dry mix joint compound was used to cover all gypsum board joints and nails heads.

Sample

The fire endurance test was conducted on the assembly described previously in this Report under "Erection Of Test Assembly". Test results relate only to items tested.

Method

The location of instrumentation within the furnace and on the test sample is shown in Appendix A.

The temperatures of the wood I joists were measured with 20 thermocouples. Thermocouple numbers 31-40 were located on bottom of the I joist and thermocouple numbers 41-50 were located on the side of joist mid depth facing North and were stapled to the trusses.

The temperatures within the interstitial space were measured with 20 thermocouples. Thermocouple numbers 61-70 were located at the center of the interstitial space mid depth and thermocouple numbers 71-80 were located at the center of the interstitial space on the bottom of the subfloor.

The temperatures between the subfloor and carpet padding were measured with 15 thermocouples and numbered 1-15.

The temperatures on top of the carpet padding (between the carpet padding and carpet) were measured with 15 thermocouples and numbered 16-30.

The unexposed temperatures were measured with 13 thermocouples and numbered 81-93. Each of the unexposed surface thermocouples was covered with a 6 by 6 in. dry ceramic fiber pad.

The deflection of the assembly was measured with five electronic transducers.

The temperatures on the unexposed side of the gypsum board (between the gypsum board and the subfloor) were measured with 10 thermocouples and numbered 51-60.

There were a total of eight camera views taken during the fire exposure period. Two cameras were positioned in the interstitial spaced in the cavities under both the kneeling and standing mannequins, both cameras were facing West. One camera was positioned in the furnace recording the exposed surface of the assembly. Four other cameras recorded separate angles of the unexposed surface of the assembly and one infrared camera recorded the unexposed surface temperatures.

Two accelerometers were placed near the East West centerline of the assembly. One was placed on the East West centerline and the other was placed 12 in. North of the East West centerline. They were both located 12 in. off the West edge of the assembly. These were used to measure the vertical acceleration of the assembly throughout the fire exposure.

Results

Throughout the test, observations were made of the character of the fire, of the conditions of the exposed and unexposed surfaces, and of other events relative to the fire resistance performance of the assembly.

Character and Distribution of the Furnace Fire - The furnace fire was luminous and well distributed throughout the test. A plot of the furnace temperature can be seen on Figure 22.

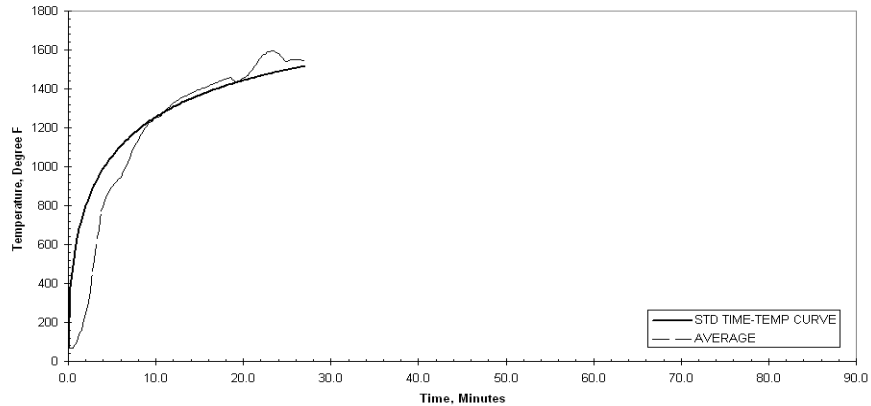

Figure 22 - UL263 Standard Time Temperature Curve and Average Furnace Temperature vs. Time for Assembly No. 4

The furnace pressure and oxygen concentration during the test are shown in Figure 23 and Figure 24.

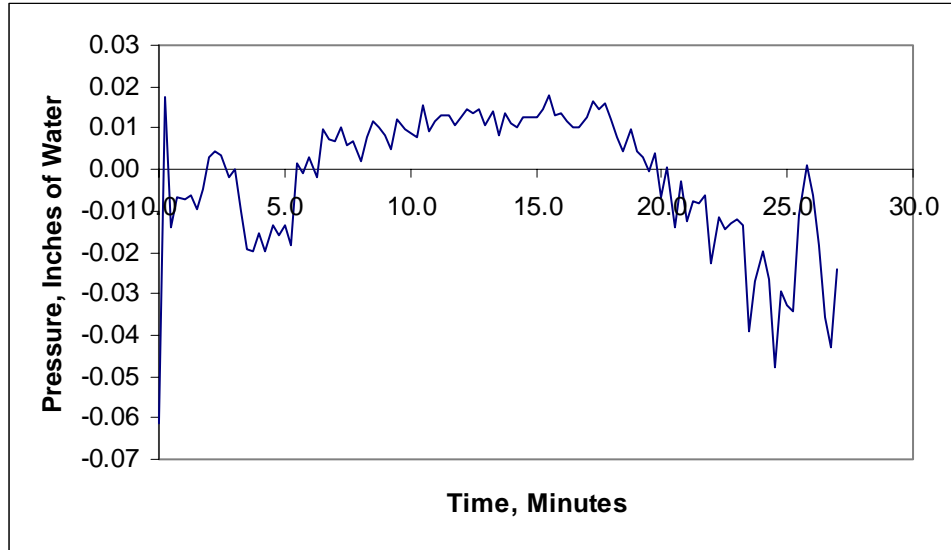

Figure 23 – Furnace Pressure vs. Time for Assembly No. 4

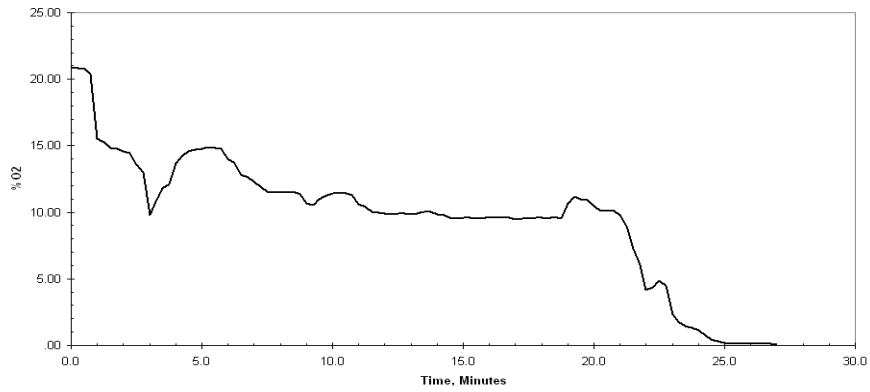

Figure 24 - Oxygen Content vs. Time for Assembly No. 4

Observations of the Exposed and Unexposed Surfaces - The observations were made during the fire test are presented in Table 7. All references to dimensions are approximate.

Table 7 – Observations for Test Assembly No. 4

Test Time, Min:Sec	Exposed (E) or Unexposed (U) Surface	Observations
1:15	E	Paper began to char.
2:00	E	Paper ignited.
2:00	U	No Change.
2:30	E	Per plenum camera, smoke was seen in plenum.
4:00	U	No Change.
4:30	E	Joint compound began to crack at butt joints.
5:30	E	Paper flaked off. (TC # 65 Backwards)
6:00	U	No Change.
7:45	E	Joint tape began to peel from board in spots.
8:00	U	No Change.
9:30	E	Board was wavy in appearance from joist to joist.
10:00	E	Joint compound began to fall off.
10:00	U	No Change.
11:00	E	Board turned gray in color
12:00	U	No Change.
12:45	E	50% of joint compound had fallen off.
14:00	U	No Change.
16:00	U	No Change.
16:45	E	85% of joint compound had fallen off.
17:15	E	Gypsum board beginning to fall on North end of assembly.
18:00	E	Gypsum board fell from Center and South ends of the assembly.
18:00	U	No Change.
18:15	U	Smoke began to emit through carpet at East Center subfloor joint.
19:00	U	Smoke at West Center subfloor joint.
19:15	E	40% of board fell off.
20:00	U	Smoke continued at all central joints.
20:40	U	Holes developed through Carpet at West Center subfloor joint at South end of assembly.
20:45	E	Heavy flaming and board continued to fall.
21:15	E	No visual observation could be made due to poor visibility.
22:26	U	Microphone on kneeling mannequin began to vibrate.
23:30	E	Crackling noises could be heard.
23:45	U	Vibrations Continued.
25:00	E	Furnace TC #15 fell.
25:00	U	Vibrations Continued.
26:45	U	Assembly Collapse.
26:45	E	Collapse

Temperatures of the Wood I Joists - The finish rating is defined as the time necessary to raise the average temperature measured on the face of the bottom chords nearest the fire 250°F or the time required to raise the temperature on the bottom chords 325°F at any point. The average temperature measured on the bottom chords of the trusses was 67°F before the test. Therefore, the average limiting temperature was 317°F and the individual limiting temperature was 392°F.

The maximum individual limiting temperature for the finish rating was reach at 7 minutes and 45 seconds as recorded by thermocouple number 31.

Temperatures of the Side of Mid Depth of Wood Joists – The average and maximum temperatures of the sides of the wood joists just before the moment of collapse (26 min 45 sec) were 1467°F and 1597°F respectively. The individual temperature was recorded by thermocouple number 48. A plot of these temperatures can be seen on Figure 25.

Temperatures of the Mid Depth Between Wood Joists – The average and maximum temperatures of the mid depth between the wood joists just before the moment of collapse (26 min 45 sec) were 1475°F and 1547°F respectively. The individual temperature was recorded by thermocouple number 70. A plot of these temperatures can be seen on Figure 25.

Temperatures of the Bottom of the Sub Floor Between Wood Joists – The average and maximum temperatures of the sub floor between the wood joists just before the moment of collapse (26 min 45 sec) were 1467°F and 1549°F respectively. The individual temperature was recorded by thermocouple number 80. A plot of these temperatures can be seen on Figure 25.

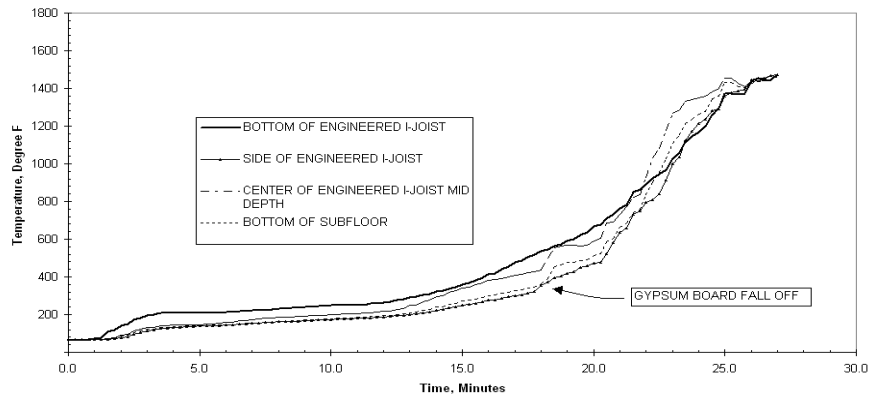

Figure 25 - Plot of Temperatures Below Subfloor vs. Time for Assembly No. 4

Temperatures of the Unexposed Side of Gypsum Board – The average and maximum temperatures of the unexposed surface just before the gypsum board fall off (17 min 15 sec) were 531°F and 634°F respectively. The individual temperature was recorded by thermocouple number 57. A plot of these temperatures can be seen on Figure 26.

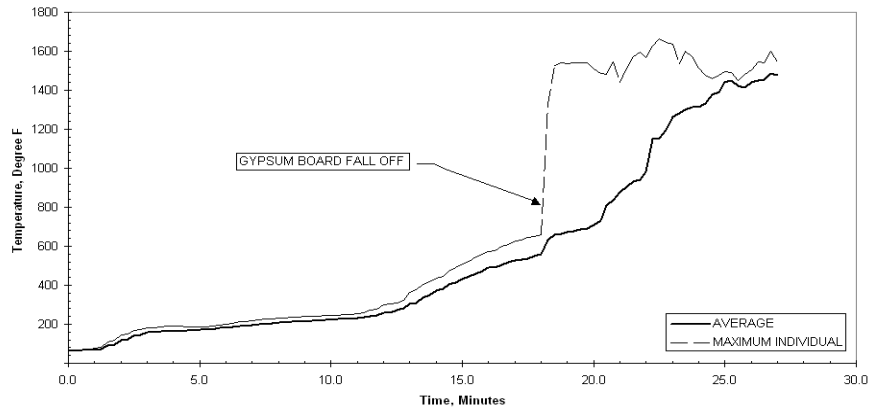

Figure 26 - Plot of Temperature of the Unexposed Surface of Gypsum Board vs. Time for Assembly No. 4

Temperatures Between the Sub Floor and Carpet Padding – The average and maximum temperatures between the sub floor and finish floor just before the moment of collapse (26 min 45 sec) were 191°F and 361°F respectively. The individual temperature was recorded by thermocouple number 7. A plot of these temperatures can be seen on Figure 27.

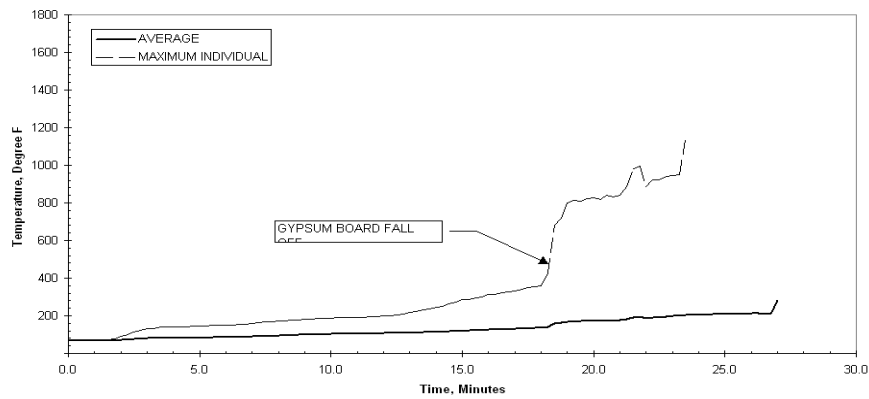

Figure 27 - Plot of Temperature of the Subfloor Temperatures vs. Time

Temperatures Between the Carpet Padding and Carpet – The average and maximum temperatures between the sub floor and finish floor just before the moment of collapse (26 min 45 sec) were 135°F and 188°F respectively. The individual temperature was recorded by thermocouple number 29. A plot of these temperatures can be seen on Figure 28.

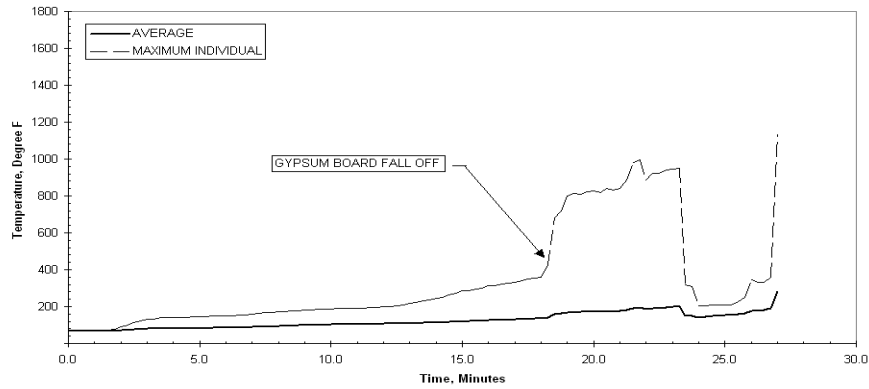

Figure 28 - Plot of Temperature of the Carpet Padding vs. Time for Assembly No. 4

Temperatures of the Unexposed Surface – The average and maximum temperatures of the unexposed surface just before the moment of collapse (26 min 45 sec) were 144°F and 355°F respectively. The individual temperature was recorded by thermocouple number 87. A plot of these temperatures can be seen on Figure 29.

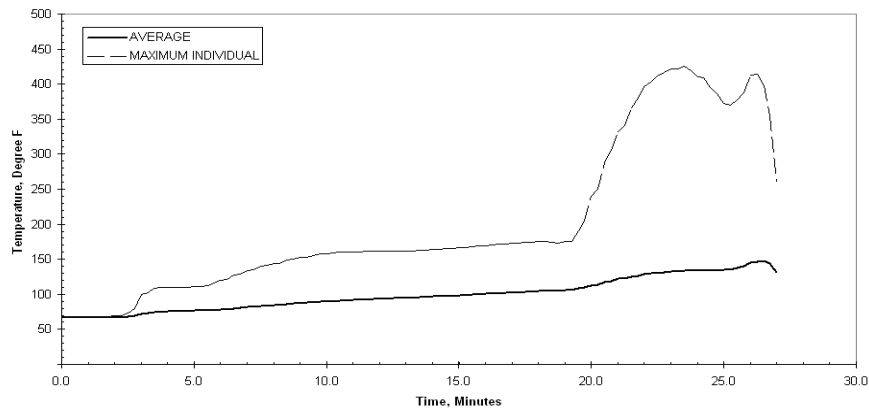

Figure 29 - Plot of Temperature of the Unexposed Surface vs. Time for Assembly No. 4

Deflection of the Assembly - The deflection of the floor-ceiling assembly during the fire test is shown on Figure 30. The location of each deflection transducer can be seen in Appendix A under Test Assembly 4.

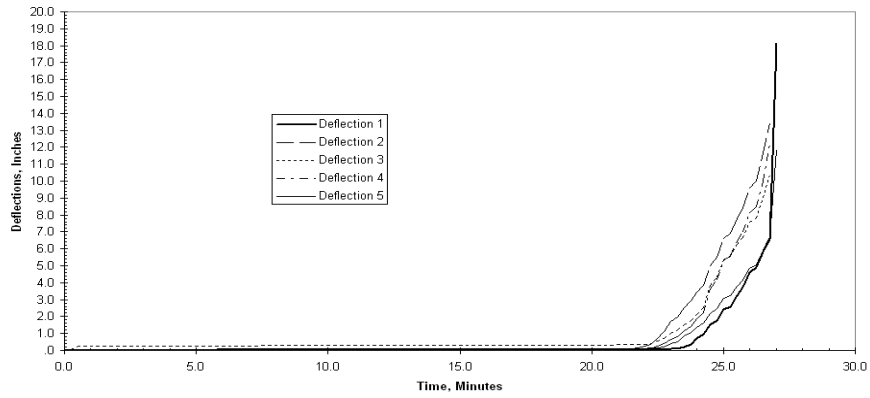

Figure 30 - Plot of Deflections vs. Time for Assembly No. 4

Test Record No. 5

Materials

Materials described in section General and used in Assembly No. 5 include engineered 2 by 6 bearing plate, subfloor (OSB), carpet and padding, tack strips, and gypsum board. Additional materials are described below.

Trusses - The parallel chord trusses were 14 in. deep, 13 ft 10 in. long fabricated from nominal 2 in. by 4 in. wood members and had an average weight of 54.08 lb. The nominal 4 in. side of the truss members was oriented in the horizontal direction. The truss members were secured together with galvanized steel plates measuring 0.036 in. thick for 1.5 in. by 4 in., 3 in. by 4 in., 3 in. by 7 in., 3.5 in. by 8 in. and 3 in. by 10 in. sizes. The plates contained 5/16 in. long teeth projecting perpendicular to the plane of the plate. The moisture content of the truss members ranged from 3.4 to 12.1 percent and averaged 9.2 percent.

End Closure – The nominal 2 in. by 4 in. dimensional lumber measured 1-1/2 in. by 3-1/2 in. and cut to lengths of 8 ft 8-5/8 in. long.

Strongback – The nominal 2 in. by 6 in. dimensional lumber measured 1-1/2 in. by 5-1/2 in. and cut to lengths of 5 ft 7-3/4 in. and 12 ft 3/8 in. long.

Erection of Test Assembly

Nominal 2 in. by 6 in. structural grade wood bearing plates were placed on top of the steel angles. The trusses were placed on the wood bearing plates and spaced 24 in. OC starting at the East West centerline of the assembly. At the North and South ends of the assembly, additional trusses, not in the field of the fire test, were placed over the vermiculite concrete in order stabilize the plywood subfloor. The average bearing at each end of the truss was 4-7/8 in. The trusses were fastened to each bearing plate with two No. 16d nails.

Nominal 2 in. by 6 in. structural grade strongback was run perpendicular to the vertical member of the trusses located 5 ft 7-1/2 in. from the West side of the assembly. The strongback was secured to the vertical wood members of the trusses with two No. 16d nails at each strongback / truss interface.

Along the east and west edges of the test assembly, nominal 2 in. by 4 in. wood headers (rim band) were spaced perpendicular to the trusses and fastened to the top chord of each truss with two No. 16d nails.

A 1/4 in. wide bead of adhesive was placed on the top chord of the trusses and into the grooved edge of the plywood. The plywood sub-floor was placed on the trusses with the 8 ft long edges positioned perpendicular to the trusses and the ends butted and centered

over trusses, with adjacent end joints staggered 4 ft. A 1/8 in. wide bead of adhesive was placed on the tip of the tongue and groove ends of the subfloor before sliding the panels together. The plywood was secured to the trusses with 1-7/8 in. ringshank underlayment nails spaced 6 in. OC at the perimeter and 12 in. OC in the field with nails 1 in. from the edge of each panel.

The pre-nailed tack strips were secured to the subfloor around the perimeter of the assembly approximately 2 in. from the inside edge of the test frame.

The 6 ft wide carpet padding had joints spaced 6 ft, 12 ft and 17 ft 6 in. starting at the West edge of the assembly. The carpet padding was secured to the subfloor with 1/4 in. long staples spaced 18 in. OC around the perimeter of each laid piece of padding.

The 14 ft 3 in. wide by 18 ft long roll of carpet was laid on top of the carpet padding. The carpet was stretched tight and secured to the carpet gripper nailing strips located at the perimeter of the entire assembly.

The gypsum board was secured to the exposed side of the assembly with 1-5/8 in. long phosphate coated drywall nails spaced 7 in. OC with nails spaced 1 in from the edge in the field and at the perimeter. The East-West gypsum board joints were staggered 48 in. as to not align any East-West joints. The North-South gypsum board joints were aligned and spaced 48 in. OC. The long edges of the boards were oriented perpendicular to the joints. Two layers of dry mix joint compound was used to cover all gypsum board joints and nails heads.

Sample

The fire endurance test was conducted on the assembly described previously in this Report under "Erection Of Test Assembly". Test results relate only to items tested.

Method

The location of instrumentation within the furnace and on the test sample are shown in Appendix A.

The temperatures of the wood trusses were measured with 20 thermocouples numbered 31-40 were located on the bottom of the trusses and thermocouple numbers 41-50 were located on the side of trusses mid depth facing North and stapled to the trusses.

The temperatures within the interstitial space were measured with 26 thermocouples. These thermocouples were numbered 61-70 and located at the center of the interstitial space mid depth. Thermocouple numbers 71-80 were located at the center of the interstitial space on the bottom of the subfloor. Thermocouples numbered 81-83 were located on the bottom metal gusset plates nearest center of assembly facing North. Thermocouples numbered 84-86 were located on the top metal gusset plates nearest center of assembly facing North.

The temperatures between the subfloor and carpet padding were measured with 15 thermocouples and numbered 1-15.

The temperatures on top of the carpet padding (between the carpet padding and carpet) were measured with 15 thermocouples and numbered 16-30.

The unexposed surface temperatures were measured with 13 thermocouples and numbered 87-99. Each thermocouple was covered with a 6 by 6 in. dry ceramic fiber pad.

The temperatures on the unexposed side of the gypsum board (between the gypsum board and the subfloor) were measured with 10 thermocouples and numbered 51-60.

The deflection of the assembly was measured with five electronic transducers.

There were a total of eight camera views taken during the fire exposure period. One camera was positioned in the furnace recording the exposed surface of the assembly, two cameras positioned in the interstitial space between the gypsum board and sub floor. Four other cameras recorded separate angles of the unexposed surface of the assembly and one infrared camera recorded the unexposed surface temperatures.

Results

Throughout the test, observations were made of the character of the fire, of the conditions of the exposed and unexposed surfaces, and of other events relative to the fire resistance performance of the assembly.

Character and Distribution of the Furnace Fire - The furnace fire was luminous and well distributed throughout the test. A plot of the furnace temperature can be seen on Figure 31.

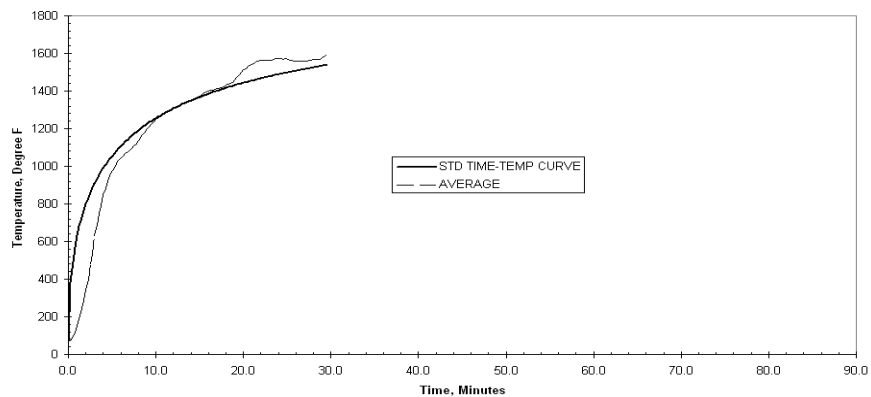

Figure 31 - UL263 Standard Time Temperature Curve and Average Furnace Temperature vs. Time for Assembly No. 5

The furnace pressure and oxygen concentration during the test are presented in Figure 32 and Figure 33.

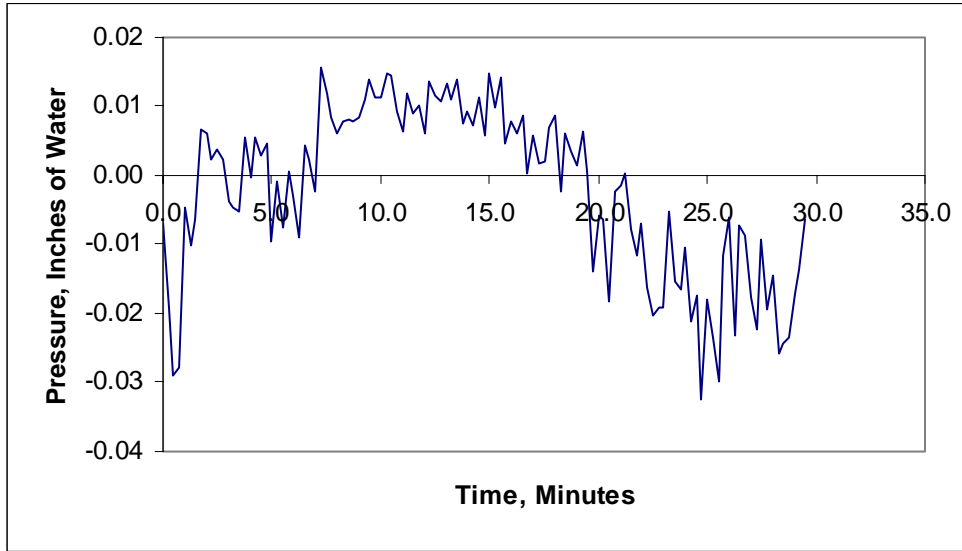

Figure 32 - Furnace Pressure vs. Time for Assembly No. 5

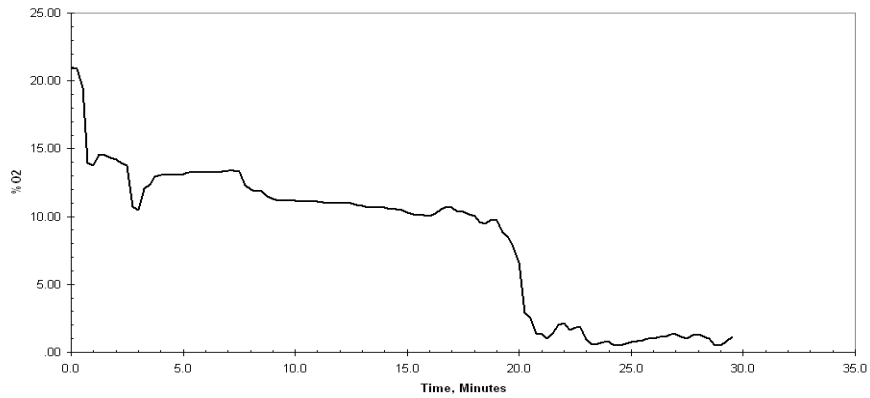

Figure 33 - Oxygen Content vs. Time for Assembly No. 5

Observations of the Exposed and Unexposed Surfaces - The observations made during the fire test are presented in Table 8. All references to dimensions are approximate.

Table 8 – Observations for Assembly No. 5

Test Time, Min:Sec	Exposed (E) or Unexposed (U) Surface	Observations
1:30	E	Paper surface ignited.
2:00	U	No change.
2:30	E	Paper charred and black in color.
4:00	U	No change.
6:00	U	No change.
6:15	E	Joint compound buckled and surface turned gray in color.
8:00	U	No change.
8:30	E	Joint compound fell from joints.
10:00	U	Smoke emitted fro perimeter of assembly at saddles and penetrations.
10:30	E	20% of joint compound had fallen off.
12:00	U	Smoke at perimeter continued. Slightly intensified.
12:30	E	Joint compound continued to fall off. 75% had fallen off.
14:00	U	No change.
16:00	U	No change.
16:30	E	2 ft by 4 ft piece of gypsum had fell off. The West adjacent had large cracks.
17:45	E	Board continued to fall off.
18:00	U	No change at perimeter. Smoke began to emit from assembly at subfloor joints.
18:15	E	Large pieces of gypsum board continued to fall. About 50%-60% gone.
18:45	E	70%-75% of the gypsum board had fallen off.
19:00	E	Crackling sounds from the trusses could be heard.
19:50	U	Crackling form assembly could be heard.
20:00	E	Could not see in furnace through windows of camera.
21:15	U	Intense smoke over entire surface. Holes could be seen through carpet at subfloor joints.
21:45	E	Crackling noises continued.
24:30	U	Flame through at TC hole.
25:30	E	Still no visual observations could be made.
25:30	U	Smoke was puffing at east side of assembly.
26:20	U	Carpet buckled at subfloor joints.
27:45	U	Flame through at west edge perimeter
28:00	E	Mannequin dropped a few inches.
28:40	U	Flame through along center truss.
28:49	E	Mannequin dropped a few inches.
29:15	E	Mannequin fell through. Gas off.
29:15	U	Mannequin fell through. Gas off.

Temperatures of the Trusses - The finish rating is defined as the time necessary to raise the average temperature measured on the face of the bottom chords nearest the fire 250°F or the time required to raise the temperature on the bottom chords 325°F at any point. The average temperature measured on the bottom chords of the trusses was 71°F before the test. Therefore, the average limiting temperature was 321°F and the individual limiting temperature was 396°F.

The maximum individual limiting temperature for the finish rating was reached at 10 minutes and 45 seconds as recorded by thermocouple number 36. A plot of the finish rating temperatures can be seen on Figure 5.4.

Temperatures at Mid Depth on the Side the Wood Trusses – The average and maximum temperatures of the sides of the wood trusses just before the moment of collapse (29 min 15 sec) were 1488°F and 1561°F respectively. The individual temperature was recorded by thermocouple number 41. A plot of these temperatures can be seen Figure 34.

Temperatures of the Mid Depth Between Wood Trusses – The average and maximum temperatures of the mid depth between the wood trusses just before the moment of collapse (29 min 15 sec) were 1464°F and 1534°F respectively. The individual temperature was recorded by thermocouple number 63. A plot of these temperatures can be seen on Figure 34.

Temperatures of the Sub Floor Between Wood Trusses – The average and maximum temperatures of the sub floor between the wood trusses just before the moment of collapse (29 min 15 sec) were 1464°F and 1538°F respectively. The individual temperature was recorded by thermocouple number 71. A plot of these temperatures can be seen on Figure 34.

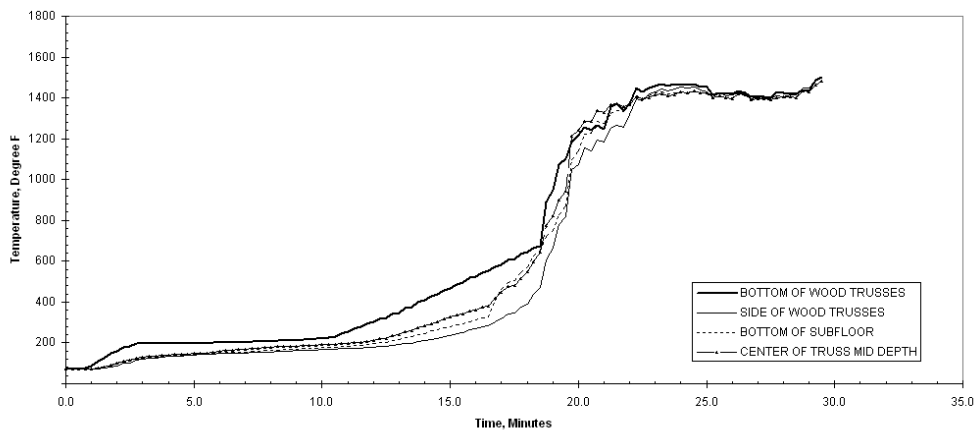

Figure 34 - Plot of Temperature of the Average Interstitial Space vs. Time for Assembly No. 5

Temperatures of the Metal Gusset Plates – The average and maximum temperatures of the top metal gusset plates just before the moment of collapse (29 min 15 sec) were 1487°F and 1537°F respectively. The individual temperature was recorded by thermocouple number 81. The average and maximum temperatures of the bottom metal gusset plate just before the moment of collapse (29 min 15 sec) were 1502°F and 1581°F respectively. The individual temperature was recorded by thermocouple number 86. A plot of the metal gusset temperatures can be seen on Figure 5.5.

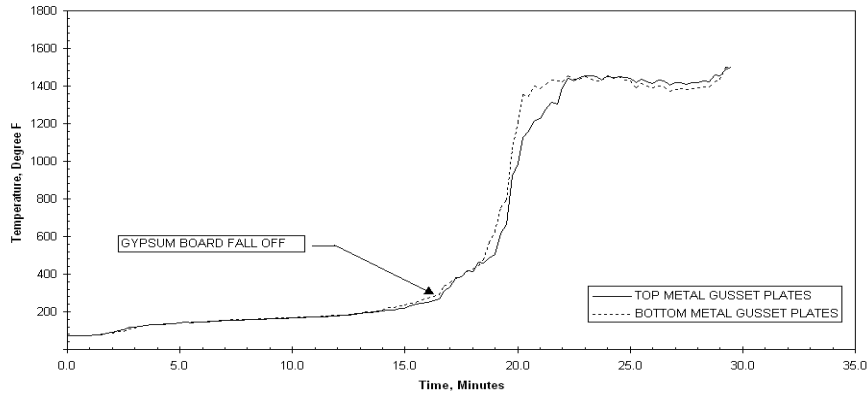

Figure 35 - Plot of Temperature of the Top and Bottom Metal Gusset Plates vs. Time for Assembly No. 5

Temperatures of the Unexposed Side of Gypsum Board – The average and maximum temperatures of the unexposed surface just before the gypsum board fall off (16 min 30 sec) were 519°F and 606°F respectively. The individual temperature was recorded by thermocouple number 54. A plot of these temperatures can be seen on Figure 36.

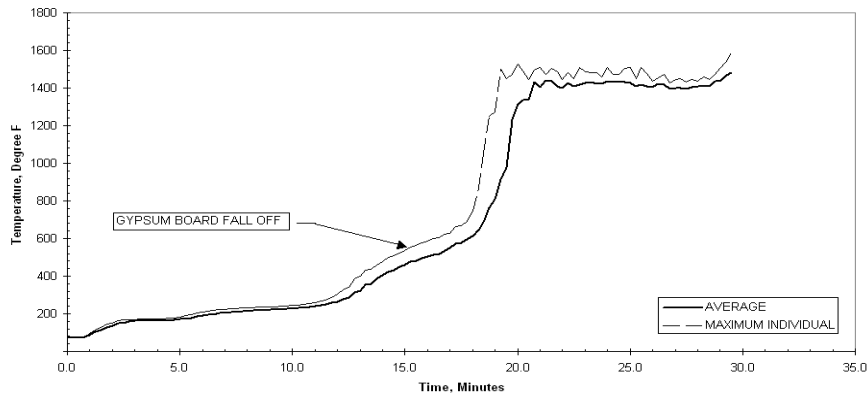

Figure 36 - Plot of Temperature of the Unexposed Surface of Gypsum Board vs. Time for Assembly No. 5

Temperatures Between the Sub Floor and Carpet Padding – The average and maximum temperatures between the sub floor and finish floor just before the moment of collapse (29 min 15 sec) were 459°F and 1416°F respectively. The individual temperature was recorded by thermocouple number 9. A plot of these temperatures can be seen on Figure 37.

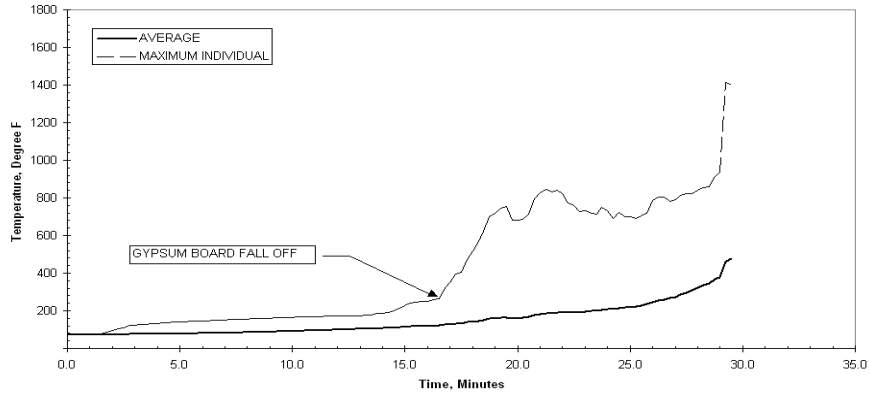

Figure 37 - Plot of Temperature of the Subfloor Temperatures vs. Time for Assembly No. 5

Temperatures Between the Carpet Padding and Carpet – The average and maximum temperatures between the sub floor and finish floor just before the moment of collapse (29 min 15 sec) were 256°F and 636°F respectively. The individual temperature was recorded by thermocouple number 24. A plot of these temperatures can be seen on Figure 38.

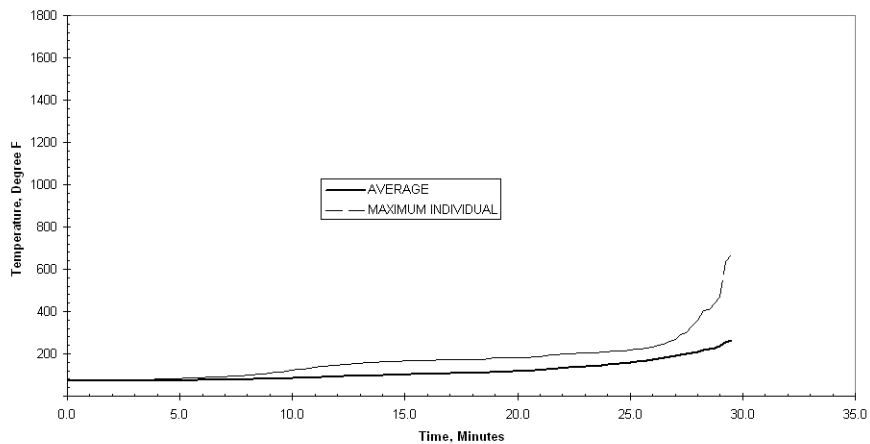

Figure 38 - Plot of Temperature of the Carpet Padding vs. Time for Assembly No. 5

Temperatures of the Unexposed Surface – The average and maximum temperatures of the unexposed surface just before the moment of collapse (29 min 15 sec) were 194°F

and 474°F respectively. The individual temperature was recorded by thermocouple number 96. A plot of these temperatures can be seen on Figure 5.9.

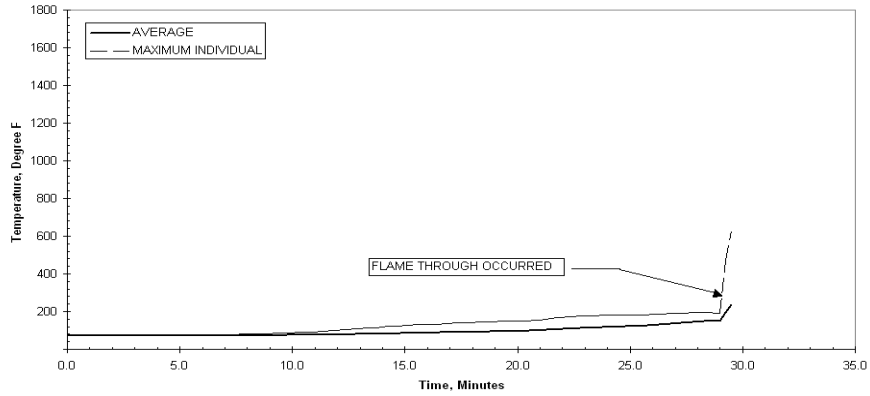

Figure 39 - Plot of Temperatures of the Unexposed Surface vs. Time for Assembly No. 5

Deflection of the Assembly - The deflection of the floor-ceiling assembly during the fire test is shown on Figure 40. The location of each deflection transducer can be seen in Appendix A under Test Assembly 5.

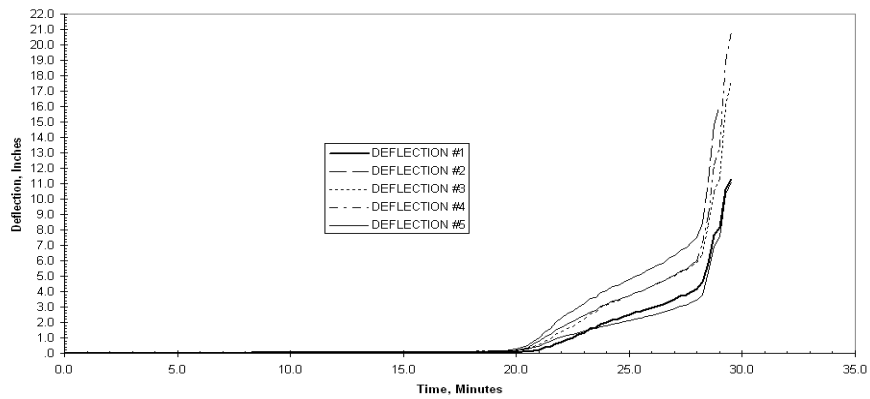

Figure 40 - Plot of Deflections vs. Time for Assembly No. 5

Test Record No. 6

Materials

Materials described in section General and used in Assembly No. 6 include engineered 2 by 6 bearing plate, subfloor (OSB), carpet and padding, tack strips, and gypsum board. Additional materials are described below.

Trusses - The glued finger jointed trusses were nominally 14 in. deep, 14 ft long fabricated from nominal 2 in. by 2 in. wood members with nominal 2 in. 3 in. wide top and bottom chords and had an average weight of 34.36 lb. The top and bottom chords measured 2-1/2 in. wide by 1-1/2 in. high. The web members measured 1-1/2 in. wide by 1-1/2 in. high and the finger penetrated 3/4 in. into the top and bottom chords. Nominal 2 in. by 6 in. and 2 in. by 8 in. wood members were used as vertical and diagonal members inside each truss. The moisture content of the truss members ranged from 4.9 to 8.4 percent and averaged 7.55 percent.

End Closure (Wood Headers) – The nominal 2 in. by 4 in. dimensional lumber measured 1-1/2 in. by 3-1/2 in. and cut to lengths of 104-5/8 in. long.

Erection of Test Assembly

Nominal 2 in. by 6 in. structural grade wood bearing plates were placed on top of the steel angles. The trusses were placed on the wood bearing plates and spaced 24 in. OC starting at the East West centerline of the assembly. At the North and South ends of the assembly, additional trusses, not in the field of the fire test, were placed over the vermiculite concrete in order stabilize the plywood subfloor. The average bearing at each end of the truss was 4-7/8 in. The trusses were fastened to each bearing plate with two No. 16d nails.

Along the east and west edges of the test assembly, nominal 2 in. by 4 in. wood headers (rim band) were placed perpendicular to the trusses and fastened to the top chord of each truss with two No. 16d nails.

A 1/4 in. wide bead of adhesive was placed on the top chord of the trusses and into the grooved edge of the plywood. The plywood sub-floor was placed on the trusses with the 8 ft long edges positioned perpendicular to the trusses and the ends butted and centered over trusses, with adjacent end joints staggered 4 ft. A 1/8 in. wide bead of adhesive was placed on the tip of the tongue and groove ends of the subfloor before sliding the panels together. The plywood was secured to the trusses with 6d ringshank underlayment nails spaced 6 in. OC at the perimeter and 12 in. OC in the field with nails 1 in. from the edge of each panel.

The pre-nailed tack strips were secured to the subfloor around the perimeter of the assembly approximately 2 in. from the inside edge of the test frame.

The 6 ft wide carpet padding had joints spaced 6 ft 12 ft and 17-1/2 ft starting at the South edge of the assembly. The carpet padding was secured to the subfloor with 1/4 in. long staples spaced 18 in. OC around the perimeter of each laid piece of padding.

The 14-1/4 ft wide by 18 ft long roll of carpet was laid on top of the carpet padding. The carpet was stretched tight and secured to the carpet gripper nailing strips located at the perimeter of the entire assembly.

The gypsum board was secured to the exposed side of the assembly with 1-5/8 in. long phosphate coated drywall nails spaced 7 in. OC with nails spaced 1 in from the edge in the field and at the perimeter. The East-West gypsum board joints were staggered 48 in. as to not align any East-West joints. The North-South gypsum board joints were aligned and spaced 48 in. OC. The long edges of the boards were oriented perpendicular to the joists. Two layers of dry mix joint compound was used to cover all gypsum board joints and nails heads.

Sample

The fire endurance test was conducted on the assembly described previously in this Report under "Erection Of Test Assembly". Test results relate only to items tested.

Method

The location of instrumentation within the furnace and on the test sample are shown in Appendix A.

The temperatures of the wood trusses were measured with 20 thermocouples. Thermocouple numbers 31-40 were located on the bottom of the trusses and thermocouple numbers 41-50 were located on the side of trusses mid depth facing North and stapled to the trusses.

The temperatures within the interstitial space were measured with 26 thermocouples. Thermocouple numbers 61-70 were located at the center of the interstitial space mid depth. Thermocouple numbers 71-80 were located at the center of the interstitial space on the bottom of the subfloor. Thermocouple numbers 81-83 were located on the bottom glued finger joints nearest center of assembly facing North and thermocouple numbers 84-86 were located on the top glued finger joints nearest center of assembly facing North.

The temperatures between the subfloor and carpet padding were measured with 15 thermocouples and numbered 1-15.

The temperatures on top of the carpet padding (between the carpet padding and carpet) were measured with 15 thermocouples and numbered 16-30.

The unexposed temperatures were measured with 13 thermocouples and numbered 87-99. Each of the unexposed surface thermocouples was covered with a 6 by 6 in. dry ceramic fiber pad.

The temperatures on the unexposed side of the gypsum board (between the gypsum board and the subfloor) were measured with 10 thermocouples and numbered 51-60.

The deflection of the assembly was measured with five electronic transducers.

There were a total of eight camera views taken during the fire exposure period. One camera was positioned in the furnace recording the exposed surface of the assembly, two cameras positioned in the interstitial space between the gypsum board and sub floor. Four other cameras recorded separate angles of the unexposed surface of the assembly and one infrared camera recorded the unexposed surface temperatures.

Results

Throughout the test, observations were made of the character of the fire, of the conditions of the exposed and unexposed surfaces, and of other events relative to the fire resistance performance of the assembly.

Character and Distribution of the Furnace Fire - The furnace fire was luminous and well distributed throughout the test. A plot of the furnace temperature can be seen on Figure 41.

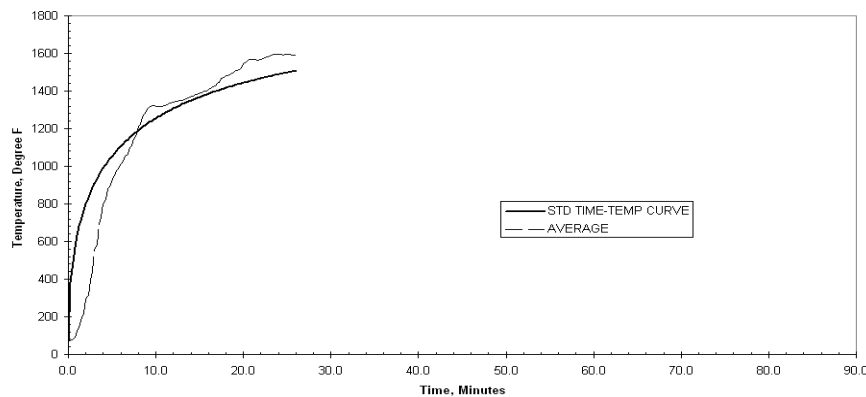

Figure 41 - UL263 Standard Time Temperature Curve and Average Furnace Temperature vs. Time for Assembly No. 6

The furnace pressure and oxygen concentration are presented in Figure 42 and Figure 43.

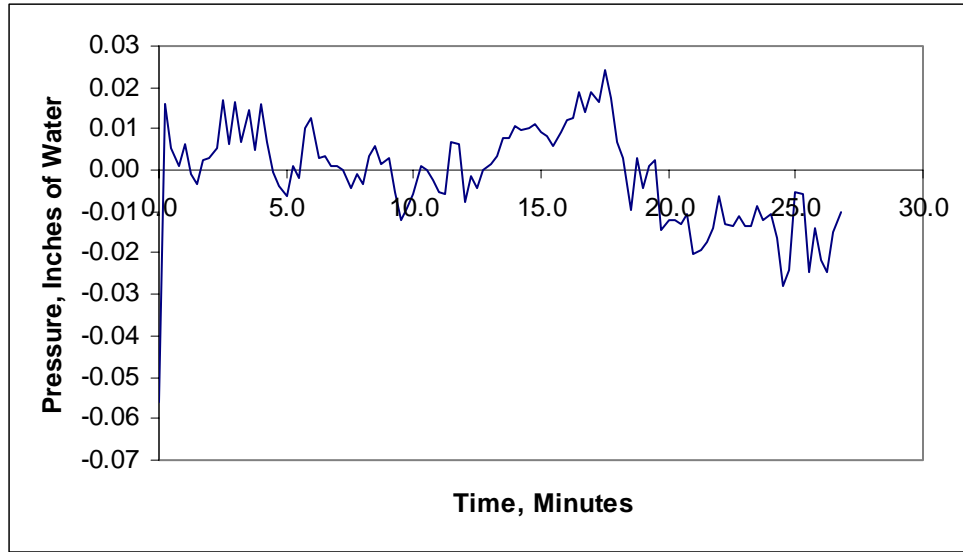

Figure 42 - Furnace Pressure vs. Time for Assembly No. 6

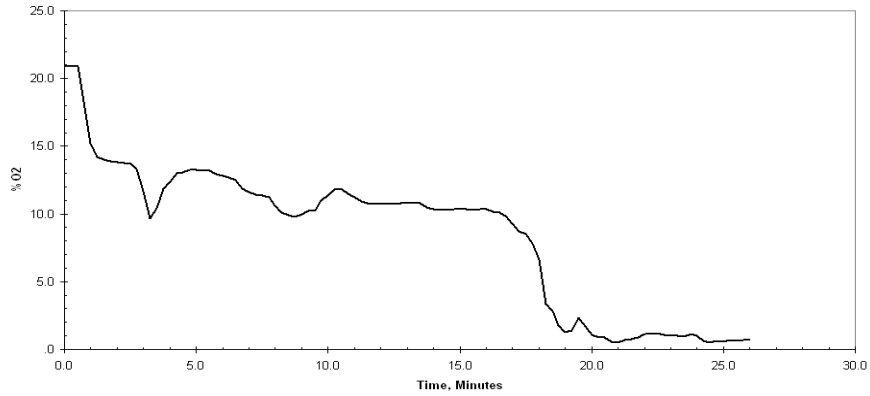

Figure 43 - Oxygen Content vs. Time for Assembly No. 6

Observations of the Exposed and Unexposed Surfaces - The observations made during the fire test are shown in Table 9. All references to dimensions are approximate.

Table 9 – Observations for Assembly No. 6

Test Time, Min:Sec	Exposed (E) or Unexposed (U) Surface	Observations
2:00	E	Paper surface ignited.
2:00	U	No change.
4:00	U	No change.
4:30	E	Surface charred and began to flake.
6:00	U	Smoke emitting from perimeter at saddles.
7:00	E	Joint compound began to crack along joints and started to peel away.
7:30	E	Surface gray in color.
8:00	U	No change.
10:00	U	No change.
10:30	E	Joint compound began to fall off.
12:00	U	Smoke increased at saddles.
13:30	E	80% of joint compound had fallen off.
14:00	U	No change.
15:30	E	North Center gypsum board joint opened to about 1/4 in. to 3/8 in.
16:00	E	2 ft by 3 ft piece of gypsum board fell off.
16:00	U	No change.
16:20	U	Smoke came from subfloor joints.
16:45	E	Gypsum board fall off continued.
17:00	E	Gypsum board fall off continued.
17:30	E	Gypsum board fall off continued.
17:30	U	Smoke increased.
18:10	U	Holes were present through carpet at East subfloor joint. Crackling could be heard.
18:45	E	No visual observations could be made.
19:20	U	Smoke continued to increase.
23:00	U	Smoke stabilized and crackling continued. Very little deflection had occurred.
23:15	U	Standing mannequin vibrated.
23:40	U	Buckling of subfloor was present near kneeling mannequin.
23:51	U	Both mannequins vibrated.
24:00	U	Sudden drops in surface as truss joints popped.
24:23	U	Both mannequins vibrated.
25:54	U	Large amount of deflection was visible.
26:00	U	Flame through at West edge. East and Center occurred shortly after.
26:45	U/E	Mannequin fell through. Gas off.

Temperatures of the Trusses - The finish rating is defined as the time necessary to raise the average temperature measured on the face of the bottom chords nearest the fire 250°F or the time required to raise the temperature on the bottom chords 325°F at any point. The average temperature measured on the bottom chords of the trusses was 70°F before the test. Therefore, the average limiting temperature was 320°F and the individual limiting temperature was 395°F.

The maximum individual limiting temperature for the finish rating was reached at 12 minutes and 15 seconds as recorded by thermocouple number 39. A plot of the finish rating temperatures can be seen on Figure 6.4.

Temperatures at Mid Depth on the Side the Wood Trusses – The average and maximum temperatures of the sides of the wood trusses just before the moment of collapse (26 min 45 sec) were 1422°F and 1487°F respectively. The individual temperature was recorded by thermocouple number 45. A plot of these temperatures can be seen on Figure 6.4.

Temperatures of the Mid Depth Between Wood Trusses – The average and maximum temperatures of the mid depth between the wood trusses just before the moment of collapse (29 min 45 sec) were 1403°F and 1474°F respectively. The individual temperature was recorded by thermocouple number 66. A plot of these temperatures can be seen on Figure 6.4.

Temperatures of the Sub Floor Between Wood Trusses – The average and maximum temperatures of the sub floor between the wood joists just before the moment of collapse (29 min 45 sec) were 1411°F and 1476°F respectively. The individual temperature was recorded by thermocouple number 75. A plot of these temperatures can be seen on Figure 6.4.

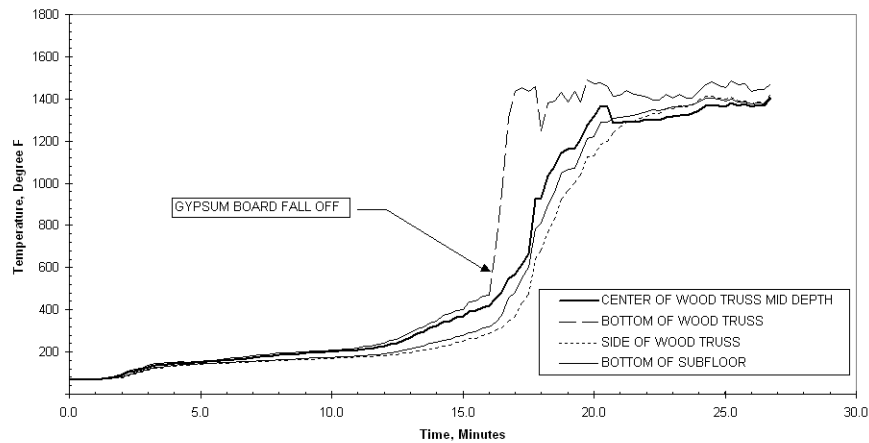

Figure 44 - Plot of Temperatures of Below Subfloor vs. Time

Temperatures of the Glued Finger Joints – The average and maximum temperatures of the top glued finger joints just before the moment of collapse (29 min 45 sec) were 1435°F and 1477°F respectively. The individual temperature was recorded by thermocouple number 84. The average and maximum temperatures of the bottom glued finger joints just before the moment of collapse (29 min 45 sec) were 1434°F and 1474°F respectively. The individual temperature was recorded by thermocouple number 81. A plot of the glued finger joint temperatures can be seen on Figure 6.5.

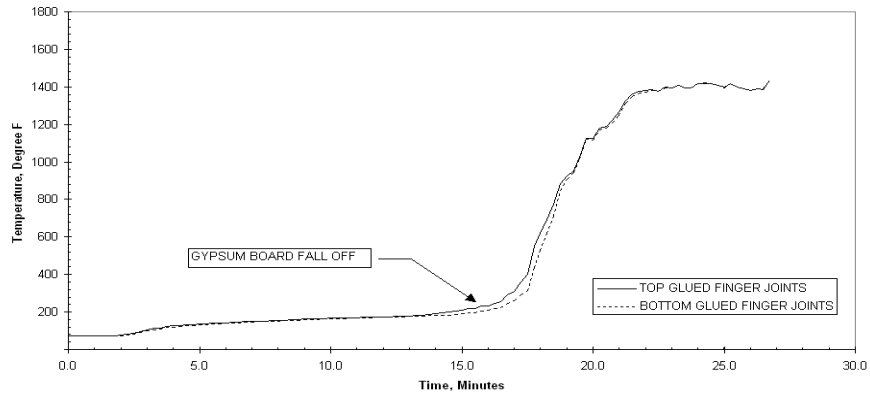

Figure 45 - Plot of Temperature of the Top and Bottom Glued Finger Joints vs. Time for Assembly No. 6

Temperatures of the Unexposed Side of Gypsum Board – The average and maximum temperatures of the unexposed surface just before the gypsum board fall off (16 min) were 559°F and 650°F respectively. The individual temperature was recorded by thermocouple number 52. A plot of these temperatures can be seen on Figure 46.

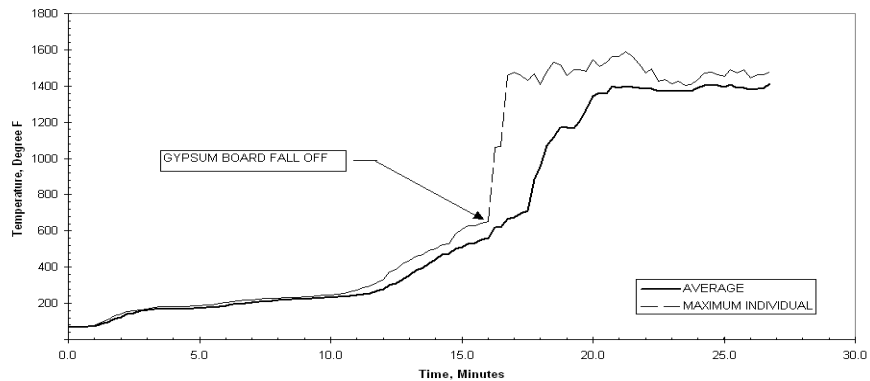

Figure 46 - Plot of Temperature of the Unexposed Surface of Gypsum Board vs. Time for Test Assembly No. 6

Temperatures Between the Sub Floor and Carpet Padding – The average and maximum temperatures between the sub floor and finish floor just before the moment of collapse (29 min 45 sec) were 424°F and 1240°F respectively. The individual temperature was recorded by thermocouple number 9. A plot of these temperatures can be seen on Figure 47.

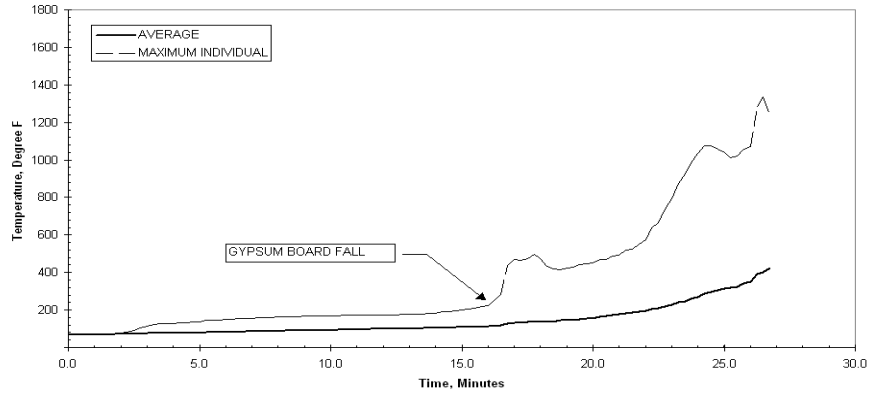

Figure 47 - Plot of Temperature of the Subfloor Temperatures vs. Time for Test Assembly No. 6

Temperatures Between the Carpet Padding and Carpet – The average and maximum temperatures between the sub floor and finish floor just before the moment of collapse (29 min 45 sec) were 241°F and 843°F respectively. The individual temperature was recorded by thermocouple number 24. A plot of these temperatures can be seen on Figure 48.

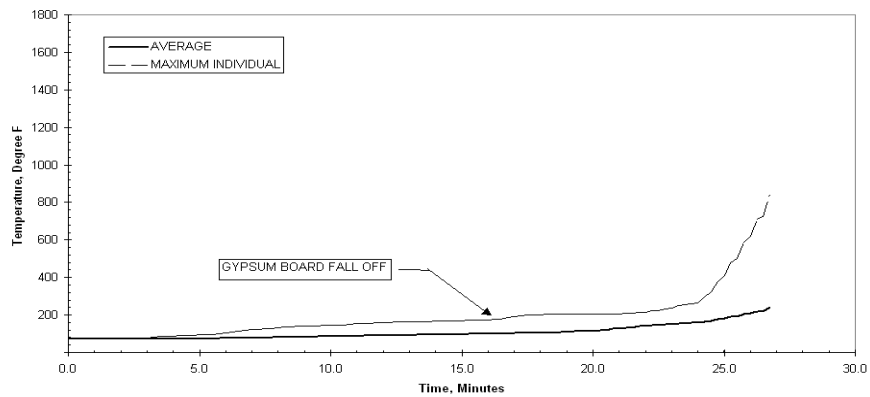

Figure 48 - Plot of Temperature of the Carpet Padding vs. Time for Test Assembly No. 6

Temperatures of the Unexposed Surface – The average and maximum temperatures of the unexposed surface just before the moment of collapse (29 min 45 sec) were 182°F and 646°F respectively. The individual temperature was recorded by thermocouple number 92. A plot of these temperatures can be seen on Figure 49.

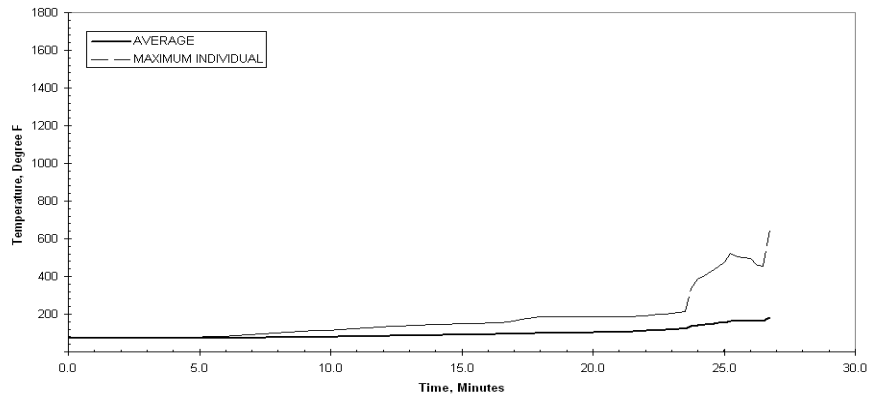

Figure 49 - Plot of Temperatures of the Unexposed Surface vs. Time for Test Assembly No. 6

Deflection of the Assembly - The deflection of the floor-ceiling assembly during the fire test is shown on Figure 50. The location of each deflection transducer can be seen in Appendix A under Test Assembly 6.

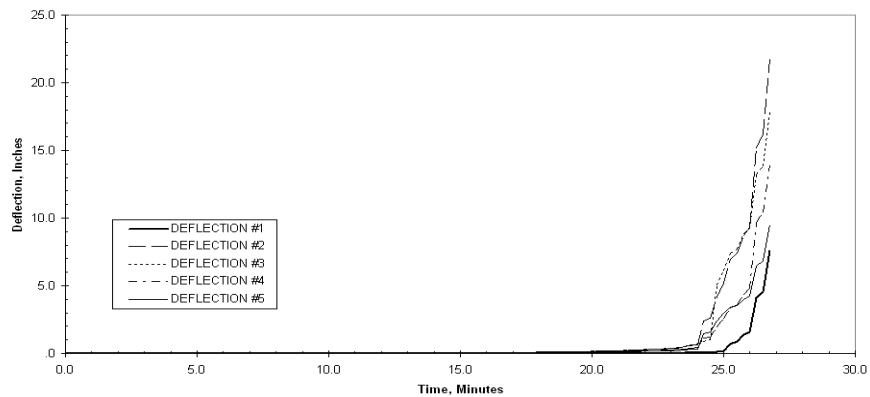

Figure 50 - Plot of Deflections vs. Time for Test Assembly No. 6

Test Record No. 7

Materials

Materials described in section General and used in Assembly No. 7 include engineered 2 by 4 bearing plate, No. 30 asphalt felt, faced batt insulation, gypsum board, and Class A asphalt shingles. Additional materials are described below.

Joist – The nominal 2 in. by 6 in. dimensional lumber measured 1-1/2 in. by 5-1/2 in. and cut to a length of 14 ft 1/12 in. long.

Blocking – The nominal 2 in. by 6 in dimensional lumber was cut to fit the area at the end of each joist. The installed pieces measured 1-1/2 in. by 4-7/8 in. and the top was cut to an angle of approximately 9.5°.

Rafters - The nominal 2 in. by 6 in. dimensional lumber measured 1-1/2 in. by 5-1/2 in. and cut to a length of 6 ft 11-7/8 in. long.

Ridge Beam – The nominal 2 in. by 8 in. dimensional lumber measured 1-1/2 in. by 7-1/2 in. and cut to a length of 13 ft 12-1/4 in. long.

Roof Deck – The nominal 1 in. by 6 in. lumber measured 3/4 in. by 5-1/2 in. by 8 ft 1/4 in. long.

Mushroom Vent – The mushroom shaped attic exhaust measure 15-3/8 in. by 17-5/16 in. at the base and 11 in. by 11-3/8 in. at the cap. The base contained four holes, one at each corner, for attachment. The aluminum thickness of the vent measured on average 0.0205 in. thick. The vents weight an average of 0.975 lbs.

Erection of Test Assembly

Nominal 2 in. by 4 in. structural grade wood bearing plates were placed on top of the steel angles. The 2 in. by 6 in. wood joists were placed on the wood bearing plates and spaced 16 in. OC starting 8 in from each side of the East West centerline of the assembly. At the North and South ends of the assembly, additional joists, not in the field of the fire test, were placed over the vermiculite concrete in order stabilize the roof assembly. The average bearing at each end of the joists were 3-1/4 in. The joists were fastened to each bearing plate with two No. 8d nails. The joists were fire-stopped with nominal 2 in. by 6 in. lumber.

Nominal 2 in. by 6 in. rafters were set to a 2/12 roof system angle and positioned parallel to the horizontal joist members. The rafters were secured to the horizontal joists with four No. 16d nails at each rafter / joist interface.

The ridge beam ran perpendicular to the joists down the North South centerline and was secured to the top of each rafter with two 16d nails per side.

The 1 in. by 6 in. roof deck was installed perpendicular to the rafters. Each piece of deck was secured to each rafter with two 8d cement coated nails.

The 3 ft wide No. 30 asphalt felt was laid over the 1 in. by 6 in. roof deck with 1/4 in. long staples spaced approximately 16 in OC at the perimeter and in the field. The asphalt felt was overlapped 2 in. at each intersection.

The Class A Asphalt Shingles were installed over the No. 30 asphalt felt with four 1-1/2 in. long electro galvanized roofing nails per sheet. The shingles were installed per the manufacture's installation instructions and overlapped 4-1/2 in.

The aluminum mushroom vents were installed per the manufacture's installation instructions with four 1-1/2 long electro galvanized roofing nails per vent. There were three vents installed with the first located over the center rafter cavity and the other two located 40 in. to the North and South of the center cavity. All three vents were located 16 in. West of the ridge beam.

The R-30 attic/flat ceiling glass fiber insulation was installed in the joist cavity with 1/2 in. crown by 1/4 in. long leg staples spread approximately 6 in. to 8 in. OC.

The gypsum board was secured to the exposed side of the assembly with 1-5/8 in. long phosphate coated drywall nails spaced 7 in. OC with nails spaced 1 in from the edge in the field and at the perimeter. The East-West gypsum board joints were staggered 48 in. as to not align any East-West joints. The North-South gypsum board joints were aligned and spaced 48 in. OC. The long edges of the boards were oriented perpendicular to the joists. Two layers of dry mix joint compound was used to cover all gypsum board joints and nails heads.

Sample

The fire endurance test was conducted on the assembly described previously in this Report under "Erection Of Test Assembly". Test results relate only to items tested.

Method

The location of instrumentation within the furnace and on the test sample are shown in Appendix A.

The temperatures of the wood joists were measured with 20 thermocouples. Thermocouple numbers 31-40 were located on the bottom of the joists and thermocouple numbers 41-50 were located on the side of joists mid depth facing North and stapled to the joists.

The temperatures within the interstitial space were measured with 18 thermocouples. Thermocouple numbers 60-68 were located at the center of the interstitial space mid

depth. Thermocouple numbers 69-77 were located at the center of the interstitial space on the bottom of the subfloor.

The temperatures between the roof deck and roof felt were measured with 15 thermocouples and numbered 1-15.

The temperatures on top of the roof felt (between the roof felt and asphalt shingles) were measured with 15 thermocouples and numbered 16-30.

The unexposed temperatures were measured with 15 thermocouples and numbered 78-92. Each of the unexposed surface thermocouples was covered with a 6 by 6 in. dry ceramic fiber pad.

The temperatures on top of the mushroom vents was measured with one thermocouple per vent. Thermocouple 93 was located on the North Vent, thermocouple 94 was located on the center vent and thermocouple 95 was located on the South vent.

The temperatures on the unexposed side of the gypsum board (between the gypsum board and the subfloor) were measured with 9 thermocouples and numbered 51-59.

The deflection of the assembly was measured with five electronic transducers.

There were a total of eight camera views taken during the fire exposure period. One camera was positioned in the furnace recording the exposed surface of the assembly, two cameras positioned in the interstitial space between the gypsum board and sub floor. Four other cameras recorded separate angles of the unexposed surface of the assembly and one infrared camera recorded the unexposed surface temperatures.

Results

Throughout the test, observations were made of the character of the fire, of the conditions of the exposed and unexposed surfaces, and of other events relative to the fire resistance performance of the assembly.

Character and Distribution of the Furnace Fire - The furnace fire was luminous and well distributed throughout the test. A plot of the furnace temperature can be seen on Figure 51.

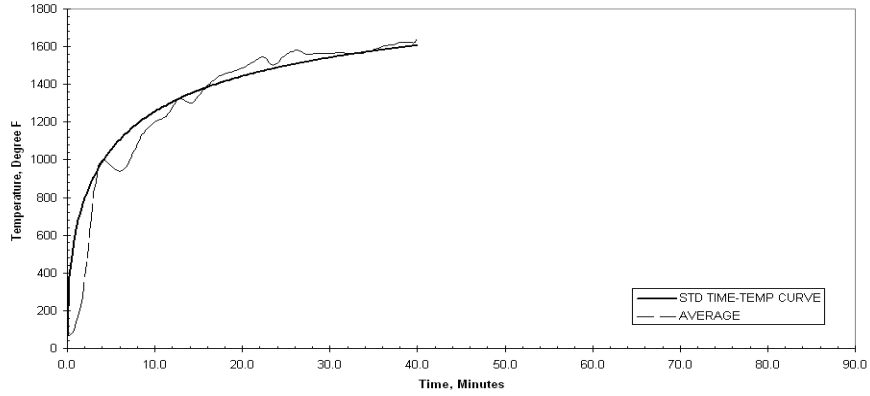

Figure 51 – UL263 Standard Time Temperature Curve and Average Furnace Temperature vs. Time for Assembly No. 7

The furnace pressure and oxygen concentration are presented in Figure 52 and Figure 53.

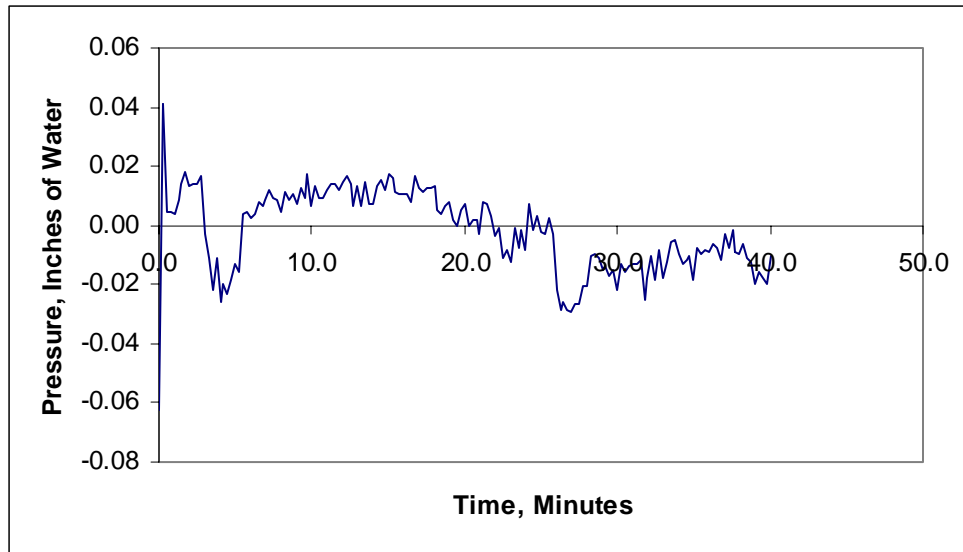

Figure 52 – Furnace Pressure vs. Time for Assembly No. 7

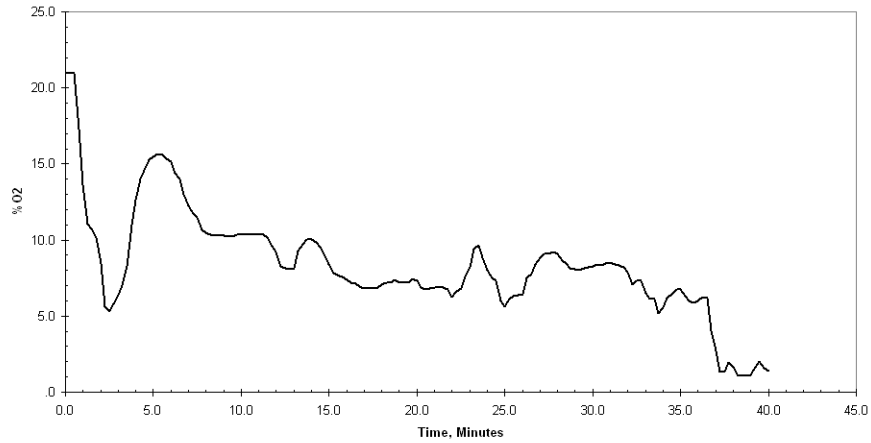

Figure 53 – Oxygen Content vs. Time for Test Assembly No. 7

Observations of the Exposed and Unexposed Surfaces - The following observations were made during the fire test. All references to dimensions are approximate.

Table 10 - Observations for Assembly No. 7

Test Time, Min:Sec	Exposed (E) or Unexposed (U) Surface	Observations
2:00	U	Smoke emitted from North vent.
3:00	U	Smoke emitted from all three vents.
4:00	E	Joint tape began to crack.
5:30	E	Joint tape began to peel back.
7:00	U	Smoke at more vent more intense than center and South vents.
7:15	E	Small pieces of joint compound began to fall.
9:00	E	Surface turned gray in color.
11:00	E	30% of joint compound had fallen off.
13:30	E	Flames present at West joint.
14:00	E	Flames present at East joint.
14:00	U	Smoke at vents grew more intense.
14:30	E	70% of joint compound had fallen off.
15:30	E	Cracks were present in gypsum board.
15:45	E	A 2ft by 2ft piece of gypsum board fell followed by a 4ft by 2 ft.
16:00	U	Smoke continued to increase in intensity.
17:00	U	Slight smoke from edge of the assembly.
17:45	E	More smaller sections of gypsum board continued to fall.
18:45	E	Small sections of gypsum board continued to fall.

Test Time, Min:Sec	Exposed (E) or Unexposed (U) Surface	Observations
19:00	U	Smoke could be seen from the shingles.
20:15	E	Insulation began to fall
21:00	U	Smoke increased in intensity and cracking could be heard.
21:45	E	Flames present where insulation fell.
22:00	U	Moisture present around vents.
23:00	U	Popping could be heard.
23:30	E	More insulation and gypsum board fell.
25:00	U	Continuous cracking could be heard.
26:00	U	Flaming occurred at North vent and smoke decreased.
27:00	U	Vents displayed puffing of smoke and flaming occurred at center vent.
28:00	U	Smoke became continuous again and flaming was also continuous.
30:00	U	Flaming around vent area. North vent has melted and is open.
32:00	U	Flaming grew in intensity at North vent.
32:15	E	Large pieces of insulation fell.
33:00	E	No visual observations could be made.
33:00	U	Shingles and tar melted around vents.
35:00	U	Kneeling mannequin's arm began to sink.
38:00	U	Hole grew larger at North vent. Kneeling mannequin fell over. Flaming at kneeling mannequin.
40:00	U/E	Mannequin fell through. Gas off

Temperatures of the Joist - The finish rating is defined as the time necessary to raise the average temperature measured on the face of the bottom of the joists nearest the fire 250°F or the time required to raise the temperature on the bottom of the joists 325°F at any point. The average temperature measured on the bottom of the joists was 70°F before the test. Therefore, the average limiting temperature was 320°F and the individual limiting temperature was 395°F.

The maximum individual limiting temperature for the finish rating was reached at 15 minutes and 15 seconds as recorded by thermocouple number 36. A plot of the finish rating temperatures can be seen on Figure 7.4.

Temperatures at Mid Depth on the Side the Wood Rafters – The average and maximum temperatures of the sides of the wood trusses just before the moment of collapse (40 min 00 sec) were 1375°F and 1476°F respectively. The individual temperature was recorded by thermocouple number 43. A plot of these temperatures can be seen on Figure 7.4.

Temperatures of the Mid Depth Between Wood Joists and Rafters – The average and maximum temperatures of the mid depth between the wood trusses just before the moment of collapse (40 min 00 sec) were 1376°F and 1482°F respectively. The individual temperature was recorded by thermocouple number 63. A plot of these temperatures can be seen on Figure 54.

Temperatures on the Bottom of the Roof Deck Between Wood Joists – The average and maximum temperatures of the sub floor between the wood joists just before the moment of collapse (40 min 00 sec) were 1383°F and 1487°F respectively. The individual temperature was recorded by thermocouple number 72. A plot of these temperatures can be seen on Figure 54

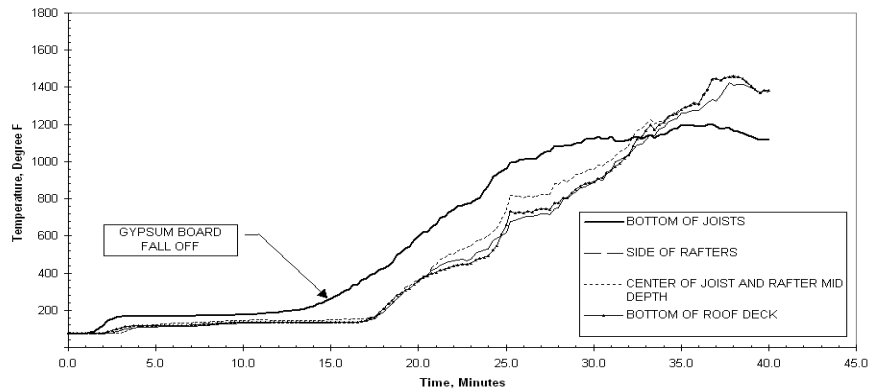

Figure 54 – Plot of Temperatures Below Subfloor vs. Time for Test Assembly No. 7

Temperatures of the Unexposed Side of Gypsum Board – The average and maximum temperatures of the unexposed surface just before the gypsum board fall off (15 min 45 sec) were 253°F and 606°F respectively. The individual temperature was recorded by thermocouple number 58. A plot of these temperatures can be seen on Figure 55

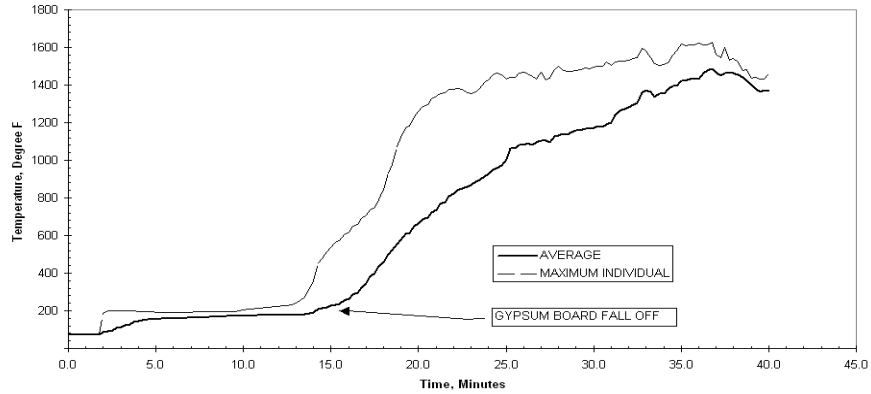

Figure 55 – Plot of Temperature of the Unexposed Surface of Gypsum Board vs. Time for Test Assembly No. 7

Temperatures on the top of the Roof Deck – The average and maximum temperatures between the roof deck and roof felt just before the moment of collapse (40 min 00 sec) were 352°F and 1585°F respectively. The individual temperature was recorded by thermocouple number 4. A plot of these temperatures can be seen on Figure 56.

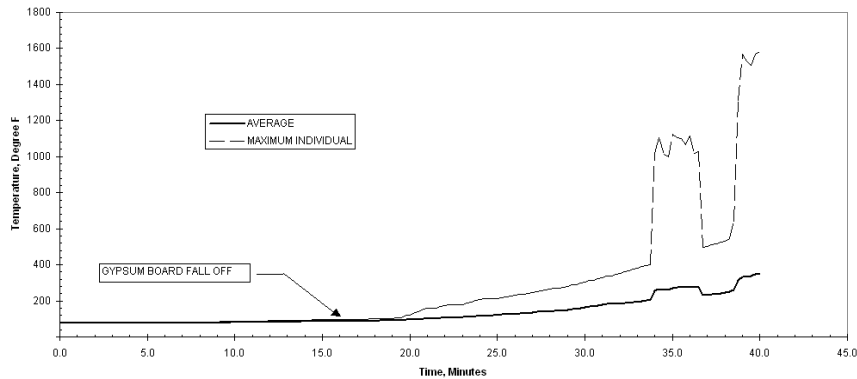

Figure 56 – Plot of the Roof Deck Temperatures vs. Time for Test Assembly No. 7

Temperatures on the Roofing Felt – The average and maximum temperatures between the sub floor and finish floor just before the moment of collapse (40 min 00 sec) were 303°F and 1129°F respectively. The individual temperature was recorded by thermocouple number 19. A plot of these temperatures can be seen on Figure 57.

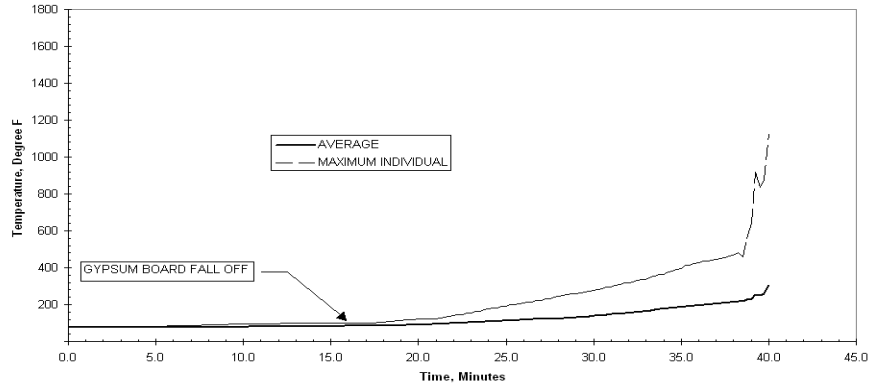

Figure 57 – Plot of Temperature of the Roofing Felt vs. Time for Test Assembly No. 7

Temperatures of the Unexposed Surface – The average and maximum temperatures of the unexposed surface just before the moment of collapse (40 min 00 sec) were 385°F and 1487°F respectively. The individual temperature was recorded by thermocouple number 81. A plot of these temperatures can be seen on Figure 58.

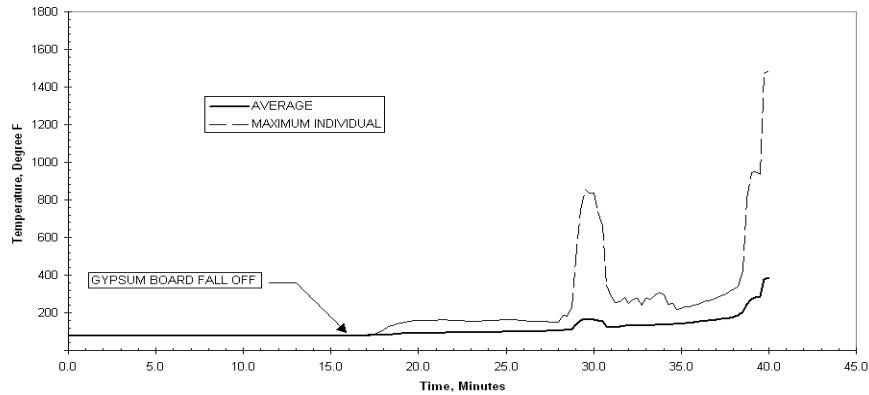

Figure 58 – Plot of Temperatures of the Unexposed Surface vs. Time for Test Assembly No. 7

Temperatures of the Unexposed Surface of the Mushroom Vents – The average and maximum temperatures of the unexposed surface just before the moment of collapse (40 min 00 sec) were 1338°F and 1470°F respectively. The individual temperature was recorded by thermocouple number 94. A plot of these temperatures can be seen on Figure 59.

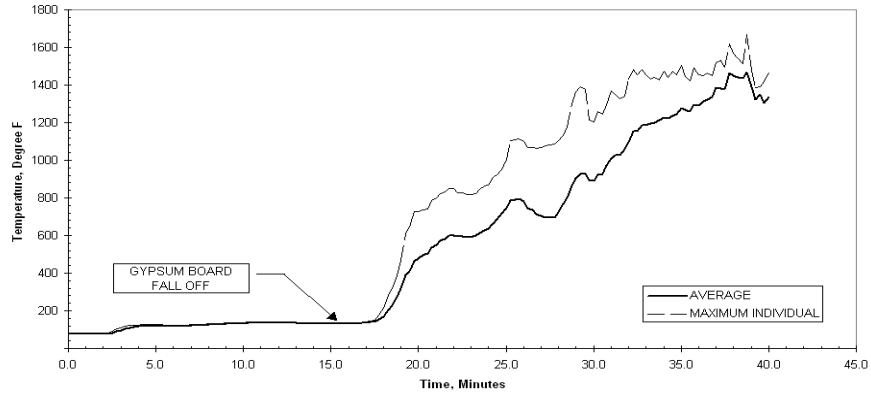

Figure 59 – Plot of Temperatures of the Unexposed Surface of the Mushroom Vent vs. Time for Test Assembly No. 7

Deflection of the Assembly - The deflection of the floor-ceiling assembly during the fire test is shown on Figure 60. The location of each deflection transducer can be seen in Appendix A under Test Assembly 7.

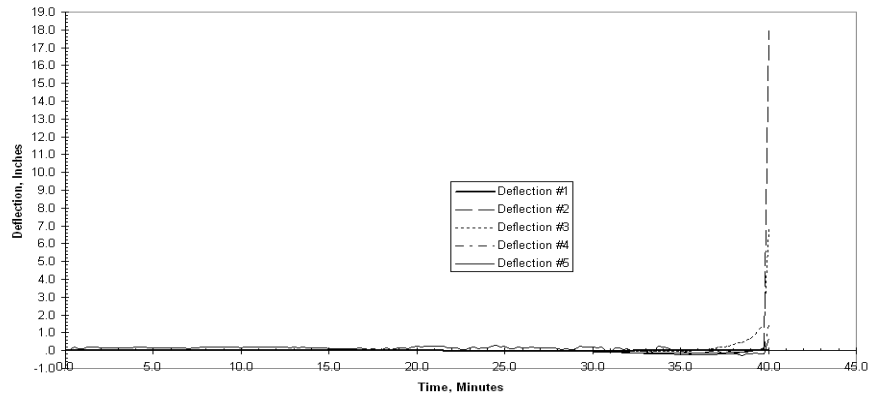

Figure 60 – Plot of Deflections vs. Time for Test Assembly No. 7

Test Record No. 8

Materials

Materials described in section General and used in Assembly No. 3 include 2 in. by 10 in. joists, 2 in. by 6 in. bearing plates, subflooring, red rosin paper and finish flooring. Additional materials are described below.

Cross Bridging – The nominal 1 in. by 3 in. dimensional lumber measured 11/16 in. by 2-7/16 in. and each end was cut at an angle and a length of 16-3/8 in.

Metal Lath – The 3.4 diamond mesh lath measured 8 ft long and 27-1/2 in wide. Each piece weighed approximately 6.25 lbs.

Square Edge Casing Bead – The 10 ft 1 in. long square edge casing bead measured 3/4 in. deep and had a top flange of 1/4 in. wide and a bottom flange of 1 in. The casing measured 0.021 in. thick. Each section weight 1.7 lbs. Holes measuring 3/16 in. in diameter were spaced 1-15/16 in. apart for fastener application.

Plaster – The plaster was applied in three separate coats the base or scratch coat, the middle or brown coat and the finish coat. The mix proportions of each are listed below.

Scratch Coat - The base coat or scratch coat was composed of 100 lbs of gypsum plaster, approximately 1.3 ft³ of sand, 7 gallons of water and 0.008 ft³ of calcium sulfate accelerator (approximately 0.2 lbs). The scratch coat had an average wet density of 123 lbs/ft³.

Brown Coat – The brown coat was composed of 100 lbs of gypsum plaster, 1.8 ft³ of sand, 7-1/2 gallons of water and 0.008 ft³ of calcium sulfate accelerator (approximately 0.2 lbs). The brown coat had an average wet density of 122 lbs/ft³.

Finish Coat – The finish coat was composed of 30.6 lbs of ivory colored autoclaved finish lime, 42.2 lbs of water and 21.9 lbs of red top gauging plaster. The finish coat had an average wet density of 96 lbs/ft³.

Erection of Test Assembly

Nominal 2 in. by 6 in. structural grade wood bearing plates were placed on top of the steel angles. The 2 in. by 10 in. joists were placed on the wood bearing plates and spaced 16 in. OC starting 8 in. from the East-West centerline of the assembly. The joists were fire stopped with 14-1/2 in. long pieces of nominal 2 by 10 in. lumber. At the North and South ends of the assembly, additional joists, not in the field of the fire for the test, were placed 2-1/2 inches from the North and South edges of the assembly over the vermiculite concrete in order stabilize the nominal 1 by 4 in. tongue and groove subfloor. The average bearing at each end of the joist was 5-1/4 in. The joists were fastened to each bearing plate with two No. 16d coated sinker nails.

The joists were stabilized by nominal 1 by 3 in. bridging cut to lengths of approximately 16-1/2 in. long with their ends cut to an angle of approximately 45 degrees. The pieces of bridging was secured diagonally opposed to each other between each pair of joists with two 6d coated sinker nails at each end of each piece.

The nominal 1 by 6 in. random length tongue and groove subfloor boards were laid diagonally (45 degrees to the joists) and secured in place with No. 8d coated sinker nails four nails per butt joint and two nails in the field at each joist.

The red rosin paper was laid over the subfloor in the East-West direction and secured in place with staples in a random order. There was a 4 in. overlap of each roll of paper.

The nominal 1 by 4 in. tongue and groove finish floor was installed over the building paper and oriented perpendicular to the joists. The finish floor was secured to the joists by 2 in. FLN-200 hardwood flooring nails spaced nominally 8 in. OC nailed through the tongue and groove using an angled flooring nailer.

A bead of fire resistive caulk was placed around the perimeter of the assembly to prevent any flame through between the frame and the test sample.

The perimeter square edge casing bead was secured with 1-1/4 in. long galvanized nails at each joist intersection. The metal lath was installed to the exposed side of the assembly using 1-1/4 in. long galvanized nails. The metal lath was overlapped 1 in. and secured to each joist with five nails and one nail at each North South overlapping intersection. The metal lath was overlapped 1-1/2 in. at each East West intersection and all overlapping occurred at a joist intersection. The metal lath was wire tied with a single strand of 18 gauge wire tie per intersection. The wire ties were spaced 16 in. OC at each joist cavity.

The three coats of plaster were applied to the metal lath to a final average thickness of 0.79 in.

Sample

The fire endurance test was conducted on the assembly described previously in this Report under "Erection Of Test Assembly". Test results relate only to items tested.

Method

The temperatures of the nominal 2 by 10 in joists were measured with 20 thermocouples. Thermocouple numbers 16-25 were located on the bottom of the joists and thermocouple numbers 26-35 were located on the side of joist mid depth facing North and stapled to the joists.

The temperatures within the interstitial space were measured with 18 thermocouples. Thermocouple numbers 45-53 were located at the center of the interstitial space mid

depth and thermocouple numbers 54-62 were located at the center of the interstitial space on the bottom of the sub floor.

The temperatures between the subfloor and finish floor were measured with 15 thermocouples and numbered 1-15.

The temperatures on the back of the metal lath were measured with 9 thermocouples and numbered 36-44.

The temperatures on the unexposed surface were measured with 15 thermocouples and numbered 63-77. Each of the unexposed surface thermocouples was covered with a 6 by 6 in. dry ceramic fiber pad.

The deflection of the assembly was measured with nine electronic transducers.

There were a total of eight camera views taken during the fire exposure period. Two cameras were positioned in the interstitial spaced in the cavities under both the kneeling and standing mannequins, both cameras were facing West. One camera was positioned in the furnace recording the exposed surface of the assembly, one infrared camera recording the unexposed surface temperatures. Four other cameras recorded separate angles of the unexposed surface of the assembly and one infrared camera recorded the unexposed surface temperatures.

Results

Throughout the test, observations were made of the character of the fire, of the conditions of the exposed and unexposed surfaces, and of other events relative to the fire resistance performance of the assembly.

Character and Distribution of the Furnace Fire - The furnace fire was luminous and well distributed throughout the test. A plot of the furnace temperature can be seen on Figure 61

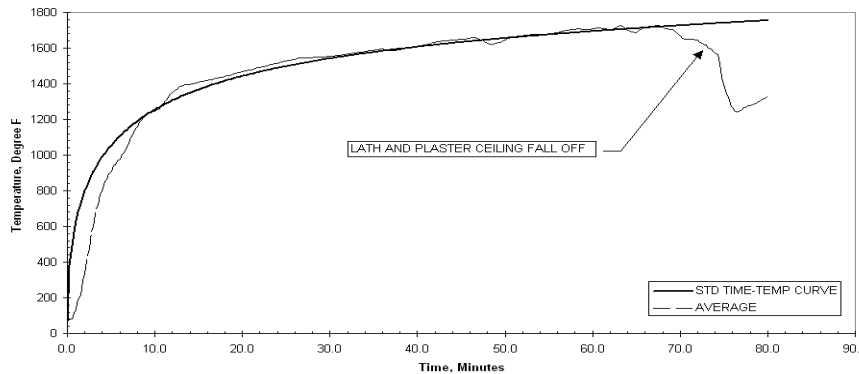

Figure 61 – UL263 Standard Time Temperature Curve and Average Furnace Temperature vs. Time for Test Assembly No. 8

The furnace pressure and oxygen concentration are presented Figure 62 and Figure 63.

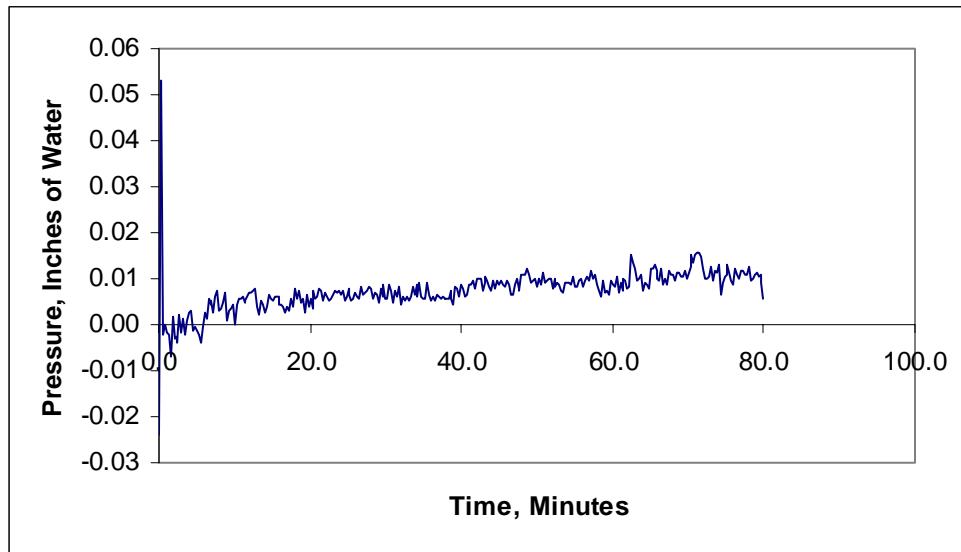

Figure 62 – Furnace Pressure vs. Time for Test Assembly No. 8

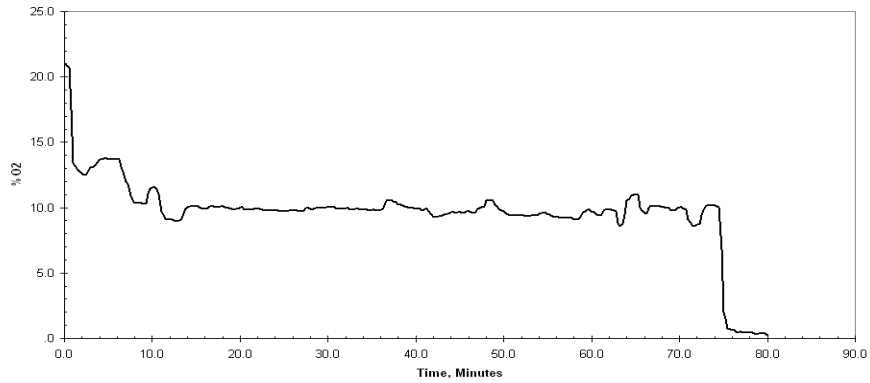

Figure 63 – Oxygen Content vs. Time for Test Assembly No. 8

Observations of the Exposed and Unexposed Surfaces - The observations made during the fire test are presented in Table 11. All references to dimensions are approximate.

Table 11 - Observations for Assembly No. 8

Test Time, Min:Sec	Exposed (E) or Unexposed (U) Surface	Observations
2:00-14:00	U	No change.
7:00	E	Discoloration could be seen.
15:30	U	Smoke emitting from North saddle on West edge.
18:00	U	Smoke emitting from both saddles on West edge.
22:00	U	No change.
26:00	U	No change.
26:00	E	No cracking in plaster but discoloration was present.
27:00	E	Thermocouple #13 malfunctioned and was taken out of the furnace average.
30:00	U	No change.
32:00	E	No change.
36:00	U	Smoke increase at west edge. Crackling of joints could be heard.
38:00	U	Crackling continued.
42:00	U	Crackling continued and no other changes.
44:20	U	Some smoke could be seen at joints in flooring.
45:00	E	Cracks appeared quickly.
46:00	E	Ceiling surface deflected quickly almost touching center thermocouple.
46:00	U	No change.
47:30	E	Cracks and deflection slowed.
50:00	U	Crackling continued. Smoke continued from finish floor.
51:10	E	Thermocouples touching ceiling surface.
54:00	E	Smoke issued from cracks.
54:00	U	No change. Very little deflection was noted.
54:45	U	Smoke increased at joints and perimeter of assembly.
58:00	U	No change.
59:00	E	Flames issued from cracks.
60:00	U	Smoke and crackling increase with no visible deflection.
62:00	E	Flame intensity increased and was more pronounced at East West edges.
64:00	E	Furnace windows were closed due to flames.
64:00	U	Smoke increase and less crackling was heard.
65:00	E	Ceiling rested on four furnace thermocouples.
67:30	U	Smoke emitting from most hardwood joints.
68:00	E	Furnace thermocouple #11 fell.
69:00	E	Furnace thermocouple #10 fell. Ceiling rested on one furnace thermocouple.
70:00	U	Smoke continued to increase with no visible deflection.
73:00	E	Furnace thermocouple #12 fell.
74:00	E	Ceiling fell and destroyed all furnace thermocouples.
74:00	U	Smoke decreased.

Test Time, Min:Sec	Exposed (E) or Unexposed (U) Surface	Observations
76:00	U	Floor deflected about 1 in.
78:30	U	Floor deflected about 2 in.
79:45	E	Mannequin fall through. Gas off.

Temperatures of the Wood Joists - The finish rating is defined as the time necessary to raise the average temperature measured on the face of the bottom surface nearest the fire 250°F or the time required to raise the temperature on the bottom surface 325°F at any point. The average temperature measured on the bottom surface of the joists was 75°F before the test. Therefore, the average limiting temperature was 325°F and the individual limiting temperature was 400°F.

The average limiting temperature for the finish rating was reached at 17 minutes as recorded by the average of thermocouple numbers 16-25.

Temperatures of the Side of Mid Depth of Wood Joists – The average and maximum temperatures of the sides of the wood joists just before the moment of collapse (79 min 45 sec) were 1395°F and 1483°F respectively. The individual temperature was recorded by thermocouple number 27. The average temperatures were plotted on Figure 64.

Temperatures of the Mid Depth Between Wood Joists – The average and maximum temperatures of the mid depth between the wood joists just before the moment of collapse (79 min 45 sec) were 1403°F and 1466°F respectively. The individual temperature was recorded by thermocouple number 46. The average temperatures were plotted on Figure 64.

Temperatures of the Sub Floor Between Wood Joists – The average and maximum temperatures of the sub floor between the wood joists just before the moment of collapse (79 min 45 sec) were 1402°F and 1464°F respectively. The individual temperature was recorded by thermocouple number 55. The average temperatures were plotted on Figure 64.

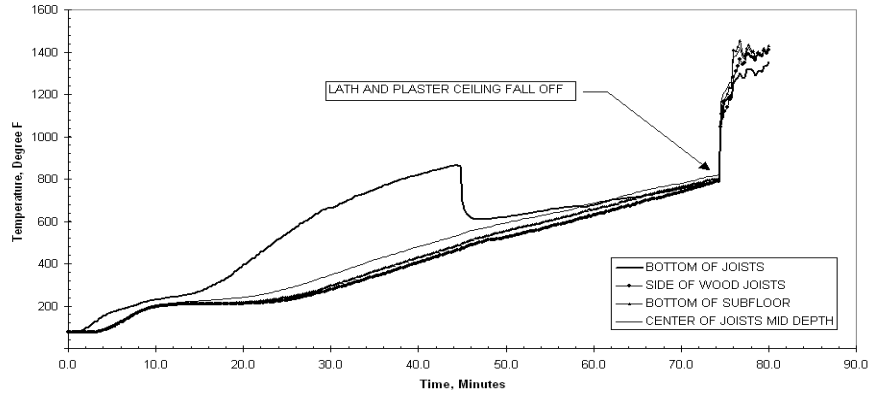

Figure 64 – Plot of Temperatures Below Subfloor vs. Time for Test Assembly No. 8

Temperatures on the Back of the Metal Lath – The average and maximum temperatures on the back of the metal lath just before the lath and plaster ceiling fall off (74 min) were 1109°F and 1259°F respectively. The individual temperature was recorded by thermocouple number 38. The average temperatures were plotted on Figure 65.

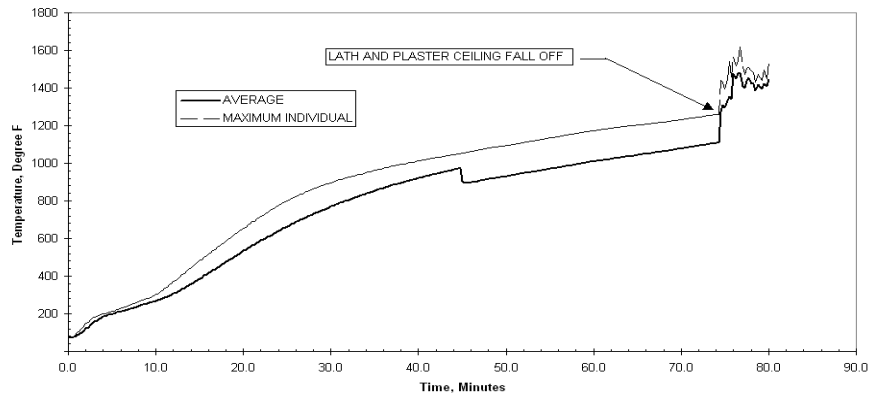

Figure 65 – Plot of Temperature of the Back of the Metal Lath vs. Time for Test Assembly No. 8

Temperatures of Between the Sub Floor and Finish Floor – The average and maximum temperatures between the sub floor and finish floor just before the moment of collapse (79 min 45 sec) were 430°F and 777°F respectively. The individual temperature was recorded by thermocouple number 4. The average temperatures were plotted on Figure 66.

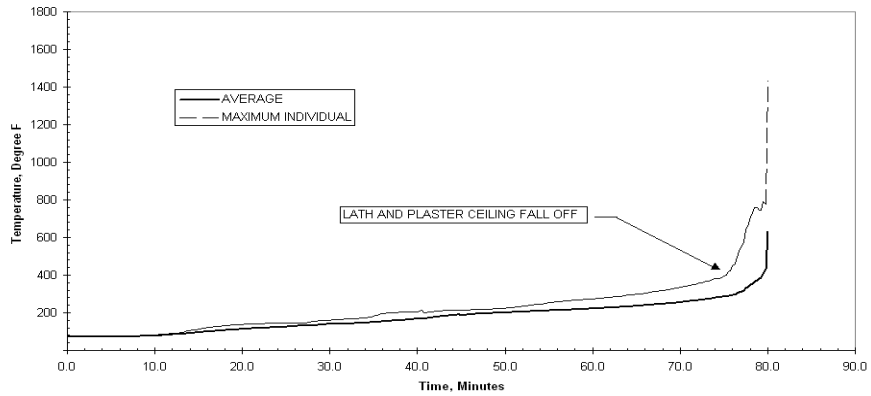

Figure 66 – Plot of Temperature of the Subfloor Temperatures vs. Time for Test Assembly No. 8

Temperatures of the Unexposed Surface – The average and maximum temperatures of the unexposed surface just before the moment of collapse (79 min 45 sec) were 174°F and 197°F respectively. The individual temperature was recorded by thermocouple number 65. The average temperatures were plotted on Figure 67.

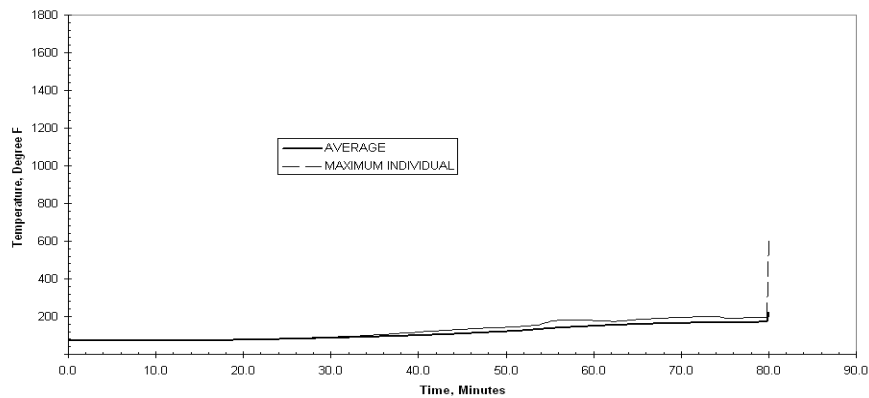

Figure 67 – Plot of Temperatures of the Unexposed Surface vs. Time for Test Assembly No. 8

Deflection of the Assembly - The deflection of the floor-ceiling assembly during the fire test is shown on Figure 68. The location of each deflection transducer can be seen in Appendix A under Test Assembly 8.

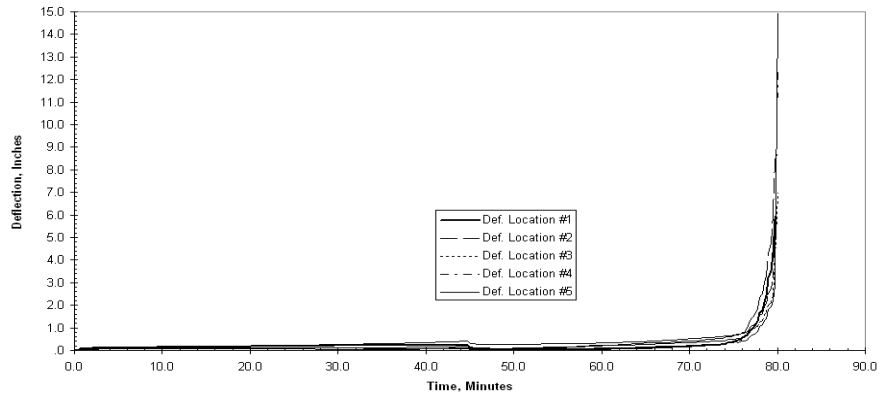

Figure 68 – Plot of Deflections vs. Time for Test Assembly No. 8

Test Record No. 9

Materials

Materials described in section General and used in Assembly No. 7 include engineered 2 by 4 bearing plate, No. 30 asphalt felt, faced batt insulation, gypsum board and Class A asphalt shingles. Additional materials are described below.

Metal Gusseted Trusses – The roof trusses were 20 in. deep at the peak, 13 ft 10 in. long and fabricated from nominal 2 in. by 4 in. wood members. The roof truss had an average weight of 36.78 lb. The nominal 4 in. side of the truss members was oriented in the vertical direction. The truss members were secured together with galvanized steel plates measuring 0.036 in. thick for 1.5 in. by 4 in., 4 in. by 4 in., 4 in. by 5 in. and 4 in. by 7 in. sizes. The plates contained 5/16 in. long teeth projecting perpendicular to the plane of the plate. The moisture content of the truss members ranged from 6.1 to 7.2 percent and averaged 6.6 percent.

Blocking – The nominal 2 in. by 8 in dimensional lumber was cut to fit the area at the end of each joist. The installed pieces measured 1-1/2 in. by 6-1/8 in.

Roof Deck – The nominal 7/16 in. thick oriented strand board roof deck measured an average of 0.45 in. thick and weighed an average of 41.54 lbs per sheet. The panels were supplied in 48 in. wide by 96 in. long panels.

Plywood Clips – The 7/16 in. high steel plywood clips measured 0.036 in. thick. The clip was arranged in a double C channel orientation. The C channels were back to back and one side measured 1-1/2 in. wide and the other measured 1/2 in. wide with the smaller side cut from the larger side.

Ridge Vent – The non-metallic ridge vents measured 13-7/8 in. wide by 4 ft long. The vents had an overall thickness of 1-1/2 in. at the center and 1 in. at the edges. Each edge of the vent contained a grid to allow the movement of air. The underside of the vent contained a filter screen. Nail holes spaced 12 in. OC with holes spaced 3-1/4 in. from the edge were present to accommodate the attachment of the vents to the roof deck.

Erection of Test Assembly

Nominal 2 in. by 6 in. structural grade wood bearing plates were placed on top of the steel angles. The metal gusseted wood trusses were placed on the wood bearing plates and spaced 24 in. OC starting at the East West centerline of the assembly. At the North and South ends of the assembly, additional trusses, not in the field of the fire test, were placed over the vermiculite concrete in order stabilize the roof assembly. The trusses were fastened to each bearing plate with two No. 16d nails. The trusses were fire-stopped with nominal 2 in. by 8 in. lumber which was cut to fit.

The far most North and South trusses were reinforced with 7/16 in. thick OSB nailed to the outside of the trusses with 8d nails spaced 6 in. OC at the perimeter and on the web members.

The 7/16 in. thick OSB roof deck was laid on top of the roof trusses. The panels were staggered 48 in. in the East West direction. In the North South direction the plywood joints were aligned and located 48 in. off the East and West edges. Plywood clips were installed 24 in. OC starting 12 in. off the center truss. The clips were only placed on the joints running in the North South direction. A 3-1/4 in. gap was left at the crest of the roof system to allow for the application of the ridge vent. The deck was attached to the trusses using 1-7/8 in. long ringshank nails space 12 in. OC in the field and 6 in. at the perimeter.

The 3 ft wide No. 30 asphalt felt was laid over the 7/16 in. OSB roof deck with 1/4 in. long staples spaced approximately 8 to 10 in. OC at the perimeter and in the field. The asphalt felt was overlapped 2 in. at each intersection.

The Class A Asphalt Shingles were installed over the No. 30 asphalt felt with four 1-1/2 in. long electro galvanized roofing nails per sheet. The shingles were installed per the manufacture's installation instructions and overlapped 4-1/2 in.

The non-metallic ridge vent was installed at the crest of the assembly per the manufacture's installation instructions with ten 16d nails per 48 in. long vent. There were four vents installed located the entire North South length of the assembly.

The R-30 attic/flat ceiling glass fiber insulation was installed in the truss cavity with 1/2 in. crown by 1/4 in. long leg staples spread approximately 6 in. to 8 in. apart.

The gypsum board was secured to the exposed side of the assembly with 1-5/8 in. long phosphate coated drywall nails spaced 7 in. OC with nails spaced 1 in from the edge in the field and at the perimeter. The East-West gypsum board joints were staggered 48 in. as to not align any East-West joints. The North-South gypsum board joints were aligned and spaced 48 in. OC. The long edges of the boards were oriented perpendicular to the joists. Two layers of dry mix joint compound was used to cover all gypsum board joints and nails heads.

Sample

The fire endurance test was conducted on the assembly described previously in this Report under "Erection Of Test Assembly". Test results relate only to items tested.

Method

The temperatures of the wood trusses were measured with 20 thermocouples. Thermocouple numbers 31-40 were located on the bottom of the trusses and

thermocouple numbers 41-50 were located on the side of trusses mid depth facing North and stapled to the trusses.

The temperatures on the unexposed side of the gypsum board (between the gypsum board and the subfloor) were measured with 10 thermocouples and numbered 51-60.

The temperatures within the interstitial space were measured with 20 thermocouples. Thermocouple numbers 61-70 were located at the center of the interstitial space mid depth. Thermocouple numbers 71-80 were located at the center of the interstitial space on the bottom of the roof deck.

The temperatures between the roof deck and roof felt were measured with 15 thermocouples and numbered 1-15.

The temperatures on top of the roof felt (between the roof felt and asphalt shingles) were measured with 15 thermocouples and numbered 16-30.

The unexposed temperatures were measured with 13 thermocouples and numbered 81-93. Each of the unexposed surface thermocouples was covered with a 6 by 6 in. dry ceramic fiber pad.

The deflection of the assembly was measured with five electronic transducers.

There were a total of eight camera views taken during the fire exposure period. One camera was positioned in the furnace recording the exposed surface of the assembly, two cameras positioned in the interstitial space between the gypsum board and sub floor. Four other cameras recorded separate angles of the unexposed surface of the assembly and one infrared camera recorded the unexposed surface temperatures.

Results

Throughout the test, observations were made of the character of the fire, of the conditions of the exposed and unexposed surfaces, and of other events relative to the fire resistance performance of the assembly.

Character and Distribution of the Furnace Fire - The furnace fire was luminous and well distributed throughout the test. A plot of the furnace temperature can be seen on Figure 69.

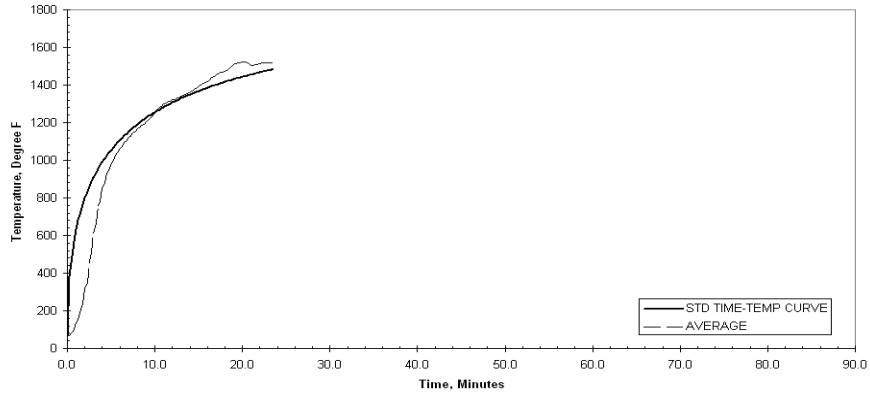

Figure 69 – UL263 Standard Time Temperature Curve and Average Furnace Temperature vs. Time for Test Assembly No. 9

The furnace pressure and oxygen concentration are presented in Figure 70 and Figure 71.

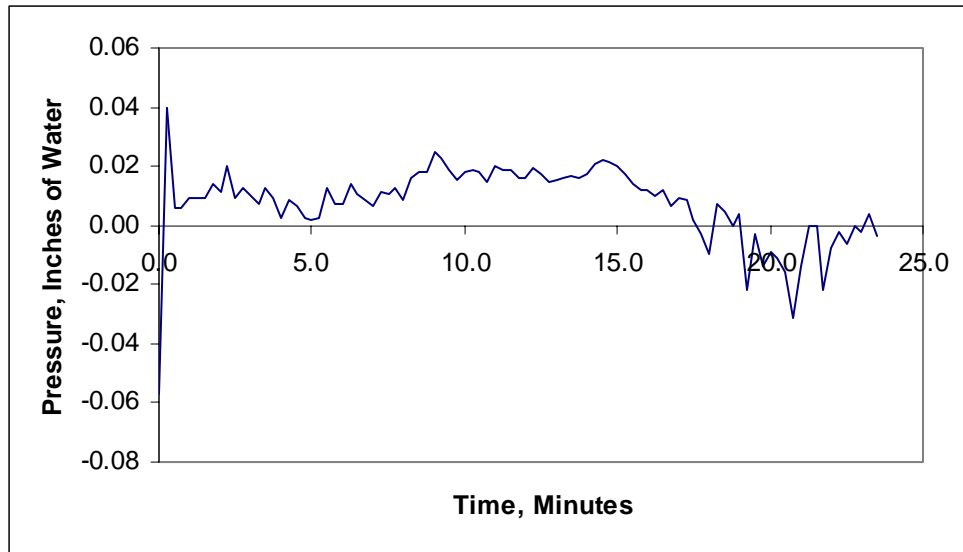

Figure 70 – Furnace Pressure vs. Time for Test Assembly No. 9

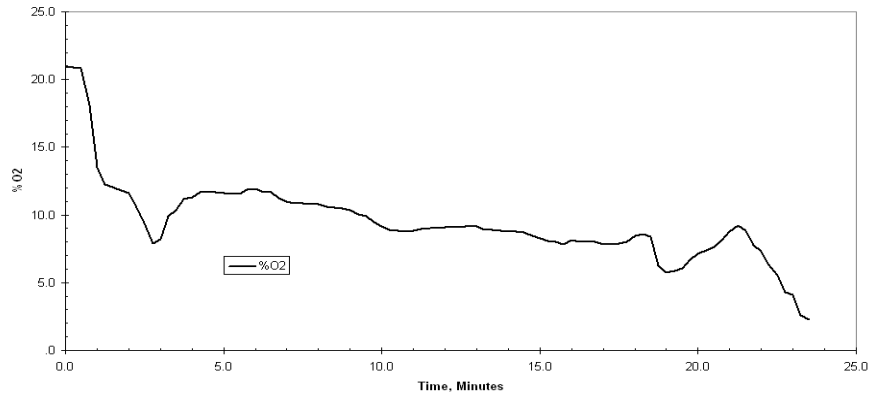

Figure 71 – Oxygen Content vs. Time for Test Assembly No. 9

Observations of the Exposed and Unexposed Surfaces - The observations made during the fire test are presented in Table 12. All references to dimensions are approximate.

Table 12 - Observations for Assembly No. 9

Test Time, Min:Sec	Exposed (E) or Unexposed (U) Surface	Observations
1:00	E	Paper surface turned dark in color.
1:30	E	Paper surface ignited.
2:00	U	Smoke at perimeter. Mainly at gable ends.
3:00	U	Smoke emitted from entire length of roof vent.
3:30	E	Surface turned black and charred
3:45	E	Joint compound began to crack.
4:15	U	Smoke was only present at ridge vent.
6:00	E	Surface turned gray in color.
6:30	U	Smoke emitted at ridge vent and gable ends.
6:30	E	Joint compound began to fall off.
7:30	E	Joint tape and compound continued to fall
9:00	U	No change.
9:00	E	Large pieces of joint compound fell off.
11:30	U	No change.
13:30	U	Smoke increased especially at ridge vent.
13:30	E	Flames could be seen from joints.
13:45	E	Pieces of gypsum board began to fall off.
14:30	E	Pieces of gypsum board continued to fall.
15:00	U	Smoke continued to increase at ridge vent.
16:00	U	Crackling of wood could be heard. Ridge vent deformed near center of assembly.
17:00	U	Really thick smoke could be seen at ridge vent.
17:15	E	Insulation fell out allowing direct path to attic space.

Test Time, Min:Sec	Exposed (E) or Unexposed (U) Surface	Observations
18:30	U	Crackling of wood could still be heard. Less smoke at center than North and South.
19:00	E	No visual observations could be seen.
21:30	U	Deformation in sheathing between trusses near mannequin locations.
22:30	U	Significant deformation at kneeling mannequin.
23:00	U	Flame through.
23:10		Kneeling mannequin fell through.
23:15	U/E	Mannequin fell through. Gas off.

Temperatures of the Trusses - The finish rating is defined as the time necessary to raise the average temperature measured on the face of the bottom of the trusses nearest the fire 250°F or the time required to raise the temperature on the bottom of the trusses 325°F at any point. The average temperature measured on the bottom of the trusses was 68°F before the test. Therefore, the average limiting temperature was 318°F and the individual limiting temperature was 393°F.

The maximum individual limiting temperature for the finish rating was reached at 14 minutes and 45 seconds as recorded by thermocouple number 40. A plot of the finish rating temperatures can be seen on Figure 9.4.

Temperatures at Mid Depth on the Side the Trusses – The average and maximum temperatures of the sides of the wood trusses just before the moment of collapse (23 min 15 sec) were 1061°F and 1432°F respectively. The individual temperature was recorded by thermocouple number 46. A plot of these temperatures can be seen on Figure 72.

Temperatures of the Mid Depth Between Wood Trusses – The average and maximum temperatures of the mid depth between the wood trusses just before the moment of collapse (23 min 15 sec) were 1255°F and 1500°F respectively. The individual temperature was recorded by thermocouple number 64. A plot of these temperatures can be seen on Figure 72.

Temperatures on the Bottom of the Roof Deck Between Wood Trusses – The average and maximum temperatures of the sub floor between the wood joists just before the moment of collapse (23 min 15 sec) were 1206°F and 1499°F respectively. The individual temperature was recorded by thermocouple number 74. A plot of these temperatures can be seen on Figure 72.

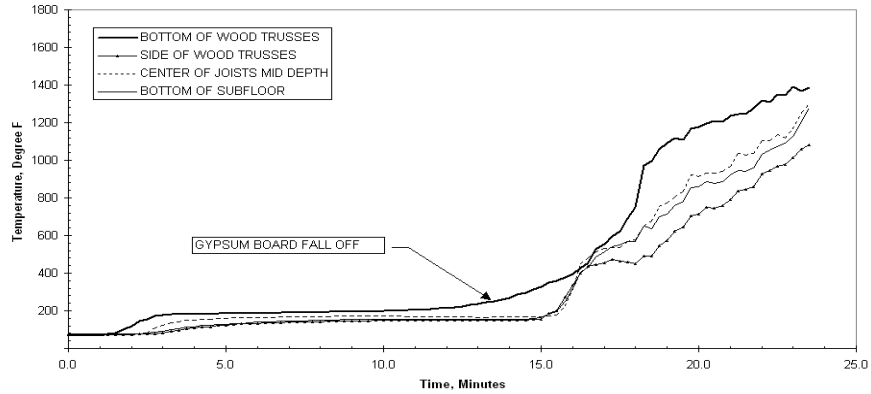

Figure 72 – Plot of Temperature Below Subfloor vs. Time

Temperatures of the Unexposed Side of Gypsum Board – The average and maximum temperatures of the unexposed surface just before the gypsum board fall off (13 min 45 sec) were 731°F and 1033°F respectively. The individual temperature was recorded by thermocouple number 56. A plot of these temperatures can be seen on Figure 73

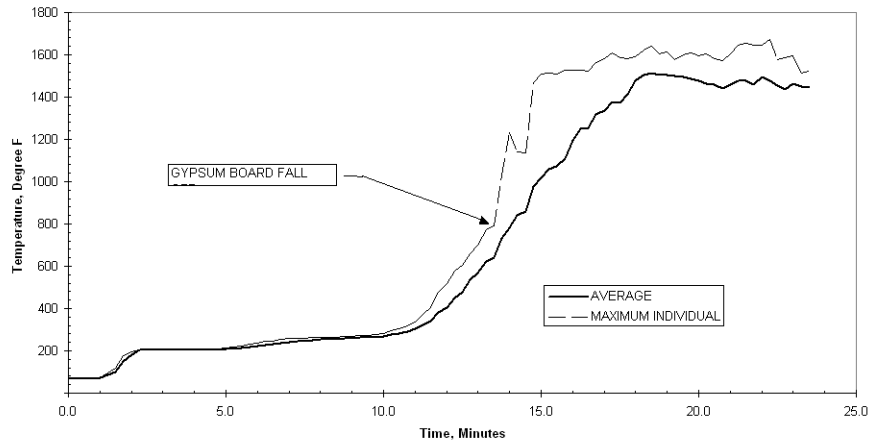

Figure 73 – Plot of Temperature of the Unexposed Surface of Gypsum Board vs. Time

Temperatures on the Top of the Roof Deck – The average and maximum temperatures between the roof deck and roof felt just before the moment of collapse (23 min 15 sec) were 249°F and 723°F respectively. The individual temperature was recorded by thermocouple number 9. A plot of these temperatures can be seen on Figure 9.6.

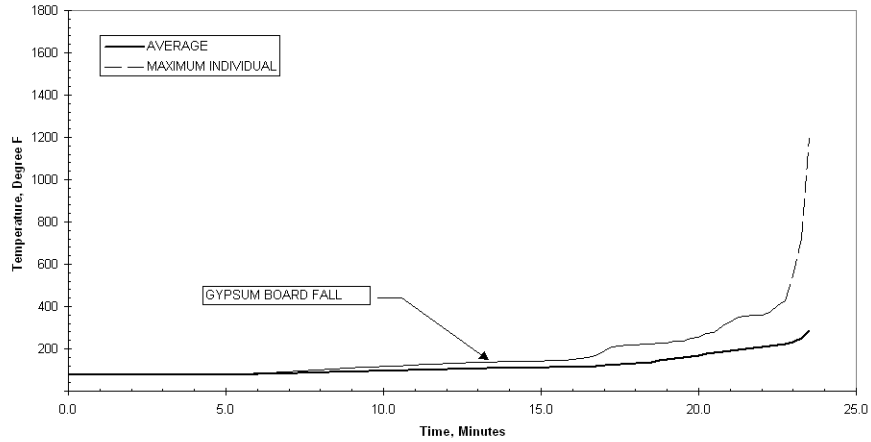

Figure 9.6 – Plot of Temperature of the Roof Deck Temperatures vs. Time

Temperatures on the Roofing Felt – The average and maximum temperatures between the sub floor and finish floor just before the moment of collapse (23 min 15 sec) were 182°F and 245°F respectively. The individual temperature was recorded by thermocouple number 23. A plot of these temperatures can be seen on Figure 9.7.

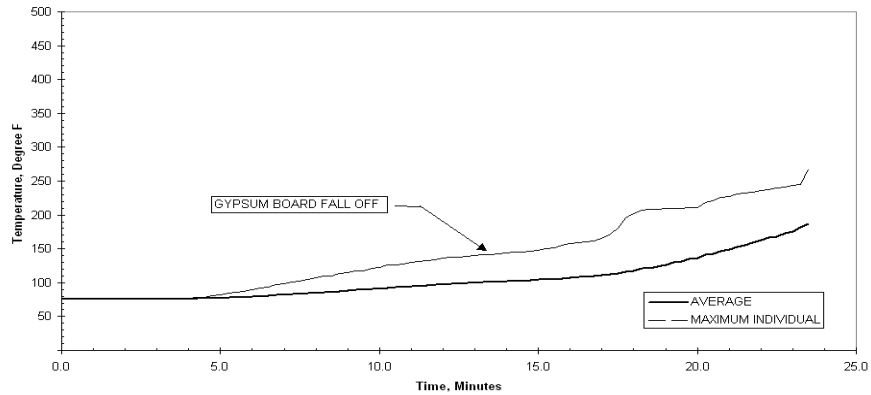

Figure 74 – Plot of Temperature of the Roofing Felt vs. Time

Temperatures of the Unexposed Surface – The average and maximum temperatures of the unexposed surface just before the moment of collapse (23 min 15 sec) were 138°F and 263°F respectively. The individual temperature was recorded by thermocouple number 92. A plot of these temperatures can be seen on Figure 75.

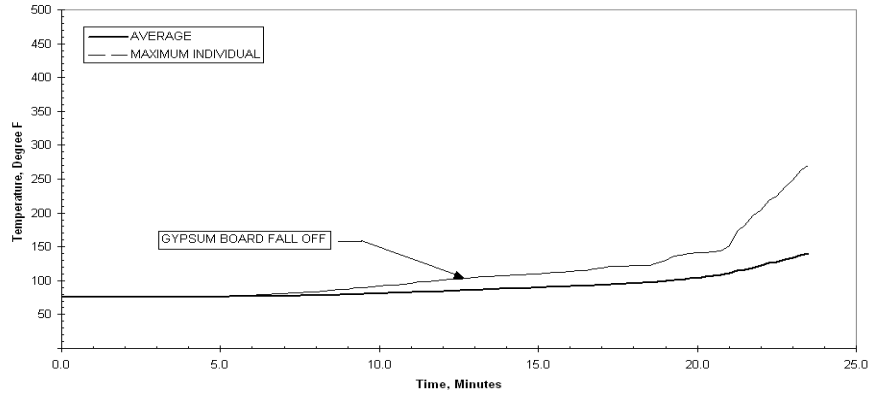

Figure 75 – Plot of Temperatures of the Unexposed Surface vs. Time

Deflection of the Assembly - The deflection of the floor-ceiling assembly during the fire test is shown on Figure 9.9. The location of each deflection transducer can be seen in Appendix A under Figure 76.

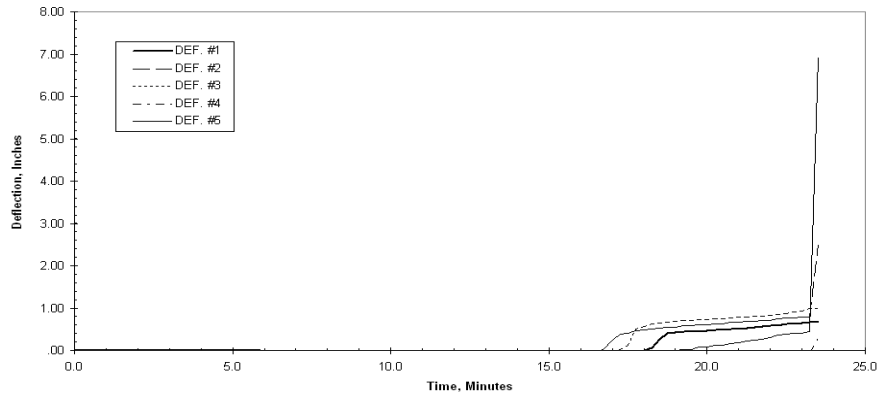

Figure 76 – Plot of Deflections vs. Time

Discussion

Furnace Conditions

The average temperature within the furnace, the pressure within the furnace and the percent oxygen content in the furnace exhaust duct were plotted in Figure 77, Figure 78 and Figure 79, respectively.

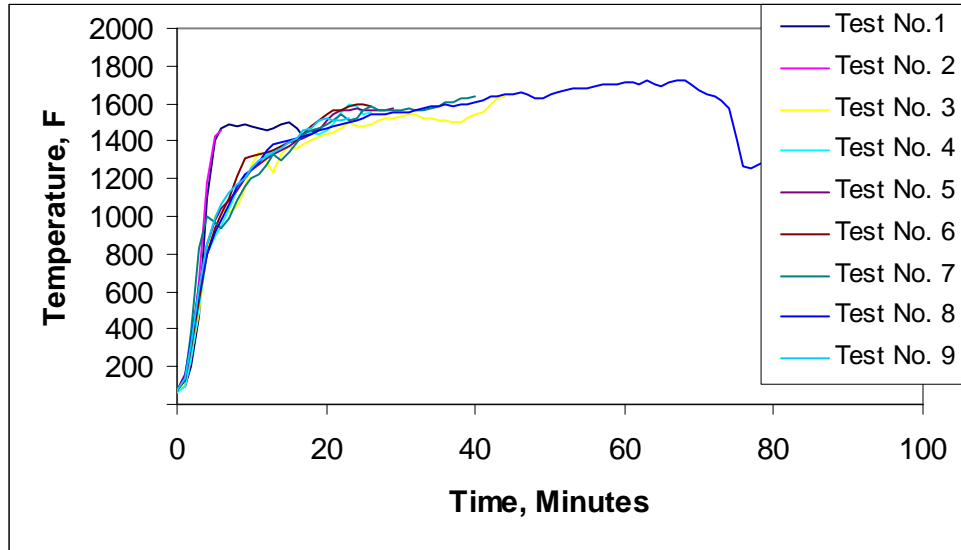

Figure 77 - Furnace Temperature

The furnace temperature during the initial portion of Test Nos. 1 and 2 were significantly higher than recorded during Test Nos. 3 through 9 because the combustible supports and sub-floors for both of these assemblies were exposed to the furnace fire at the start of the test. The relatively low furnace temperatures recorded during the later stages of Test No. 8 reflect the collapse of the plaster ceiling upon the thermocouples in the furnace.

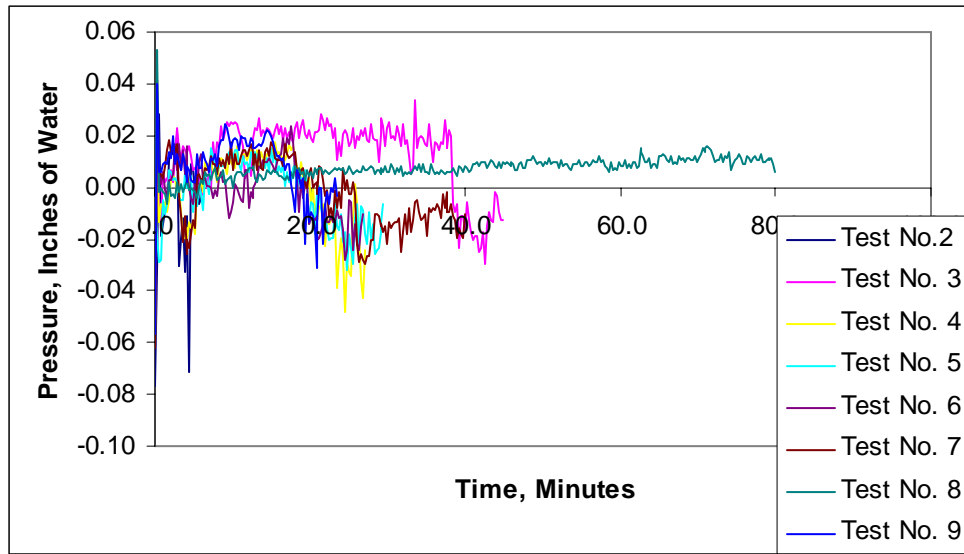

Figure 78 - Furnace Pressure

The furnace pressure was measured at a level approximately 4 inches below the ceiling surface. After the initial few minutes, the furnace pressure ranged from 0.01 to 0.02 inches of water until the ceiling fell. Then the furnace pressure became negative and ranged for 0.01 to 0.03 inches of water.

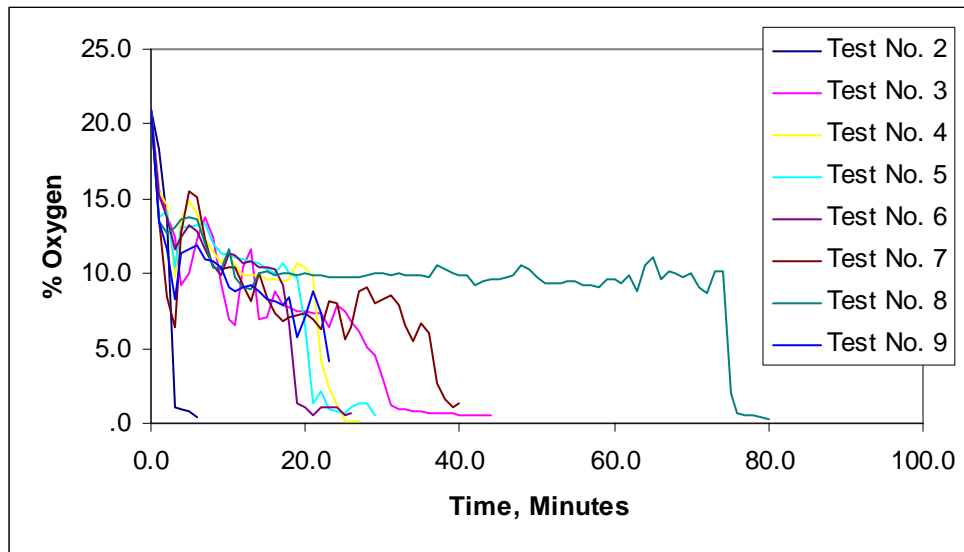

Figure 79 - Percent Oxygen in Furnace

The percent oxygen content at the beginning of the tests was approximately 19 to 20 percent and was reduced to approximately 6 to 8 percent during the tests when the ceilings were in place. The percent oxygen content dropped to near zero after the ceilings fell and the combustible supports and sub-floor were exposed to the furnace flames.

Overall, the conditions within the furnace during each of the nine fire tests were sufficiently similar to enable a comparison of the structural performance of the samples when considering the state of the test samples.

Floor and Roof Surface Temperature Conditions

The use of thermal imaging cameras by firefighters continues to grow and has many current and potential life safety applications. The temperature on the surfaces of the floor and roof were measured at several locations during each fire test. The temperatures of these surfaces at 60 seconds and at 30 seconds before collapse are shown in Figure 80 to Figure 88.

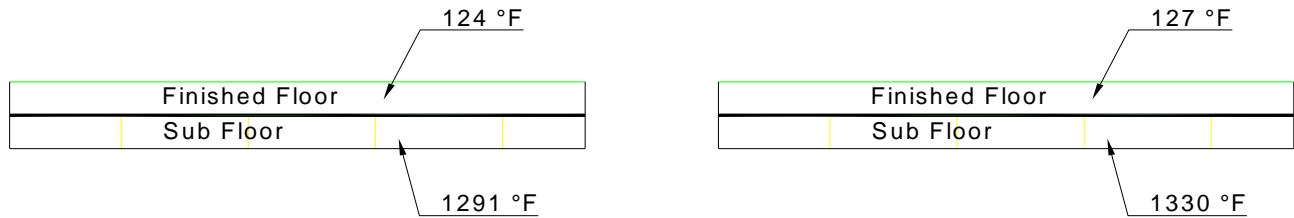

60 seconds before collapse

30 seconds before collapse

Collapse at 18 min.: 45 sec.

Figure 80 -Test Assembly No. 1

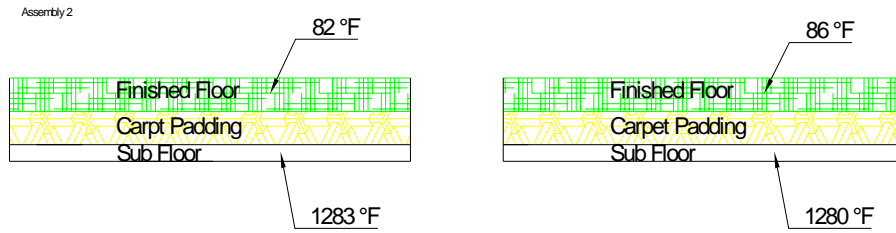

60 seconds before collapse

30 seconds before collapse

Collapse at 6 min.: 3 sec.

Figure 81- Test Assembly No. 2

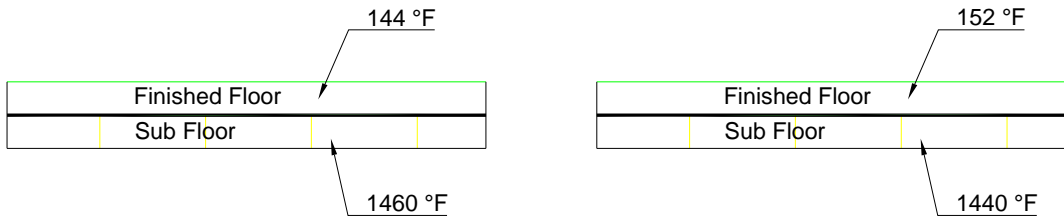

60 seconds before collapse

30 seconds before collapse

Collapse at 44 min.: 45 sec.

Figure 82 - Test Assembly No. 3

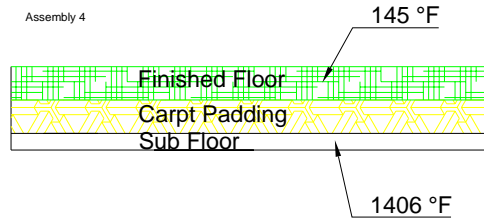

60 seconds before collapse

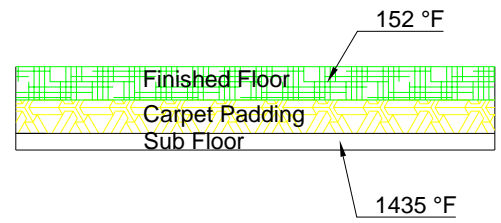

30 seconds before collapse

Collapse at 26 min.: 45 sec.

Figure 83 - Test Assembly No. 4

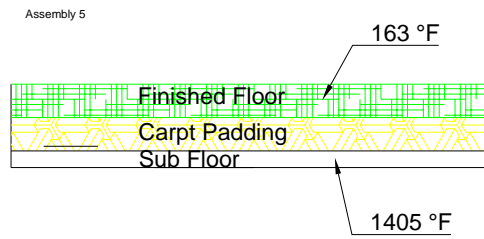

60 seconds before collapse

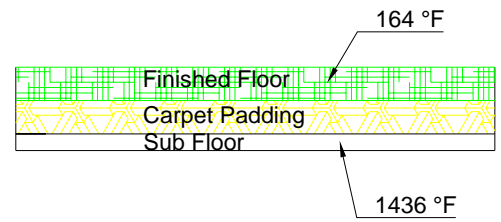

30 seconds before collapse

Collapse at 29 min.: 15 sec.

Figure 84 - Test Assembly No. 5

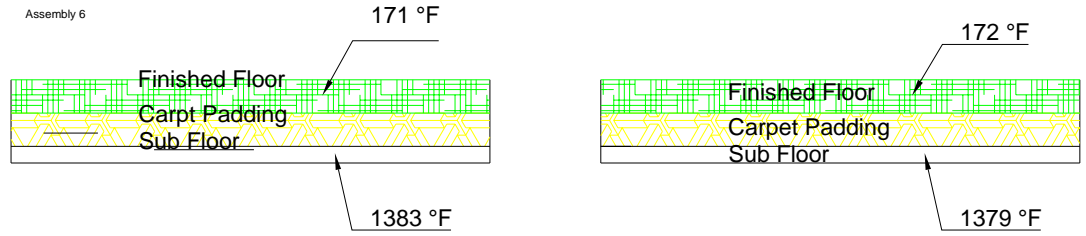

60 seconds before collapse

30 seconds before collapse

Collapse at 26 min.: 45 sec.

Figure 85 - Test Assembly No. 6

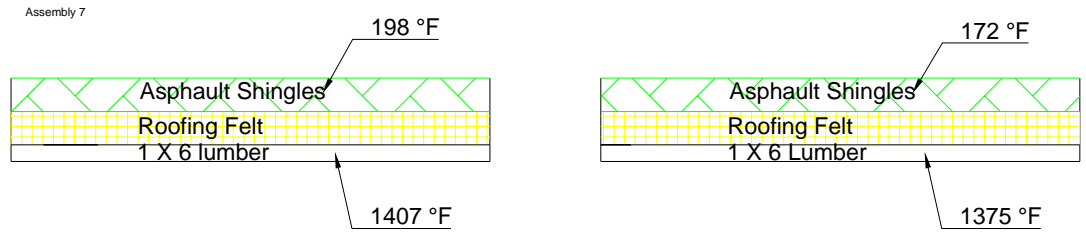

60 seconds before collapse

30 seconds before collapse

Collapse at 40 min.

Figure 86 - Test Assembly No. 7

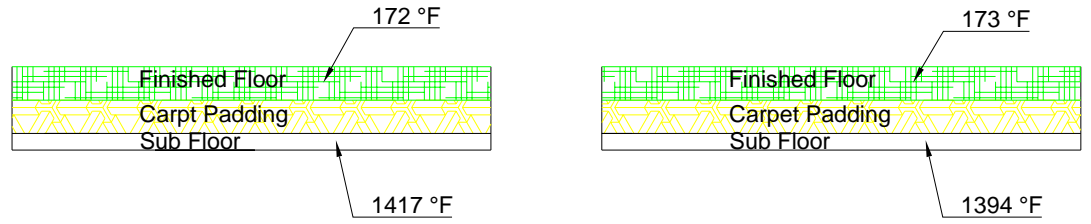

60 seconds before collapse

30 seconds before collapse

Collapse at 79 min.: 45 sec.

Figure 87 - Test Assembly No. 8

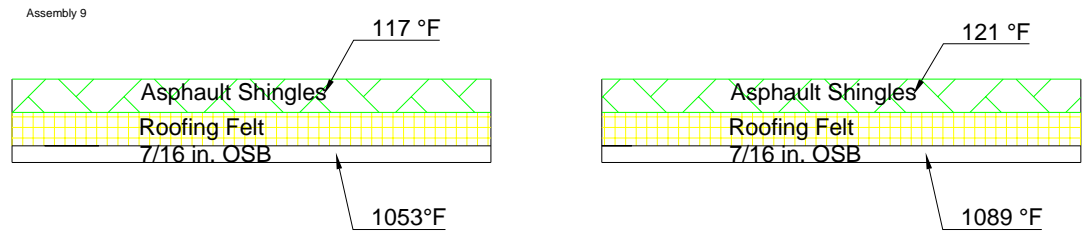

60 seconds before collapse

30 seconds before collapse

Collapse at 23 min.: 15 sec.

Figure 88 - Test Assembly No. 9

Table 15 provides a summary of the temperature data in the previous Figure 80 through Figure 88.

Table 13 - Average temperature on exposed surface of sub-floor or roof deck and average temperature on unexposed surface of floor or roofing shingles.

Assembly No.	Average temperature of exposed (lower) surface of sub-floor or roof deck 30 seconds before collapse (°F)	Average temperature of unexposed (upper) surface of floor or asphalt shingles 30 second before collapse (°F)
1	1330	127
2	1280	86
3	1440	147
4	1435	152
5	1436	164
6	1379	172
7	1375	204
8	1394	173
9	1089	121

It should be noted the relatively low temperatures on the surface viewed by the thermal imaging camera shortly before collapse as compared to the surface temperature of the sub-floor exposed to the fire.

Structural Serviceability

Firefighters have expressed concern about the rate of structure's deflection prior to collapse when reporting on experiences upon entering a fire scene and performing life safety and fire extinguishment activities. The firefighters' reports indicate the lightweight wood construction collapses at a quicker rate as compare to floors supported by 2 by 10s.

Reviewing data from Test Nos. 1 and 2 support this observation. The elapse time between the start of a continuous deflection and collapse was 13 minutes for Sample No. 1 (2 by 10s without a ceiling) and 3 minutes for Sample No. 2 (wood I joist without a ceiling). The elapse time increased when a gypsum board ceiling was installed beneath the I joist supports. The elapse time increased to 6 minutes from 3 minutes for the I joist sample with the gypsum board ceiling. For the two samples with 2 by 4 wood trusses the elapse time was 10 minutes and 7 minutes for Sample Nos. 5 and 6, respectively.

Summary of Findings

The project included the fire testing of nine combustible assemblies with the intent of documenting the significant differences, if any, in the performance of these assemblies with respect to fire containment.

Key findings included:

- The fire containment performance of a combustible floor-ceiling assembly representing typical legacy construction without a ceiling was 18 minutes. The time duration was based upon the performance of the assembly when exposed to the time-temperature curve defined in Standard ASTM E119. This performance was defined as the bench mark performance for comparison purposes.
- The fire containment performance of a combustible floor-ceiling assembly supported by engineered I joists was 14 minutes less than the bench mark performance.
- The fire containment performance of the combustible floor-ceiling assembly supported by engineered I joists with a ½ inch thick regular gypsum board ceiling exceeded the bench mark performance by 7 minutes.
- The fire containment performance of a combustible floor-ceiling assembly supported by either: (1) engineered I joists, (2) parallel chord trusses with steel gusset plate connections or (3) parallel chord trusses with glued connections were approximately equal when a ceiling consisting of ½ inch thick regular gypsum wallboard was provided.

In addition, it was noted that the temperature difference between the surface of a floor or roof covering away from the fire and the temperature of the sub-floor or the roof deck below the roof covering ranged from 968 °F to 1221 °F 30 seconds before collapse.

Appendix A – Location of Instrumentation

The location of instrumentation and materials such as thermocouples, deflection transducers, accelerometers, camera locations, joist and truss members, subflooring and finish flooring, and loading conditions are described in this Appendix.

General

Furnace Thermocouples – There were a total of 16 furnace thermocouples space symmetrically throughout the furnace in rows of four.

Assembly No. 1:

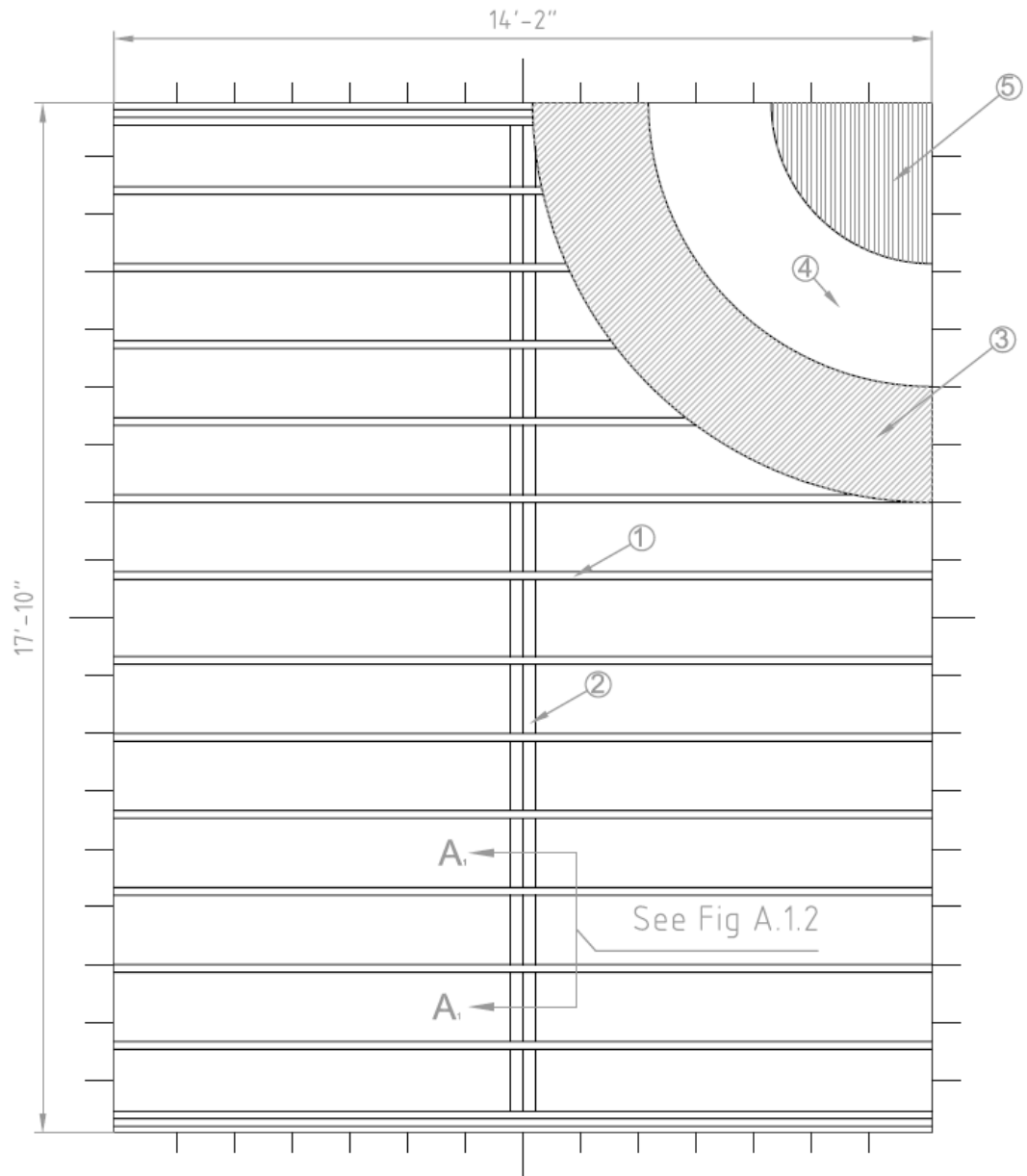

Figure A.1.1 – Construction Layout.

Assembly No. 1

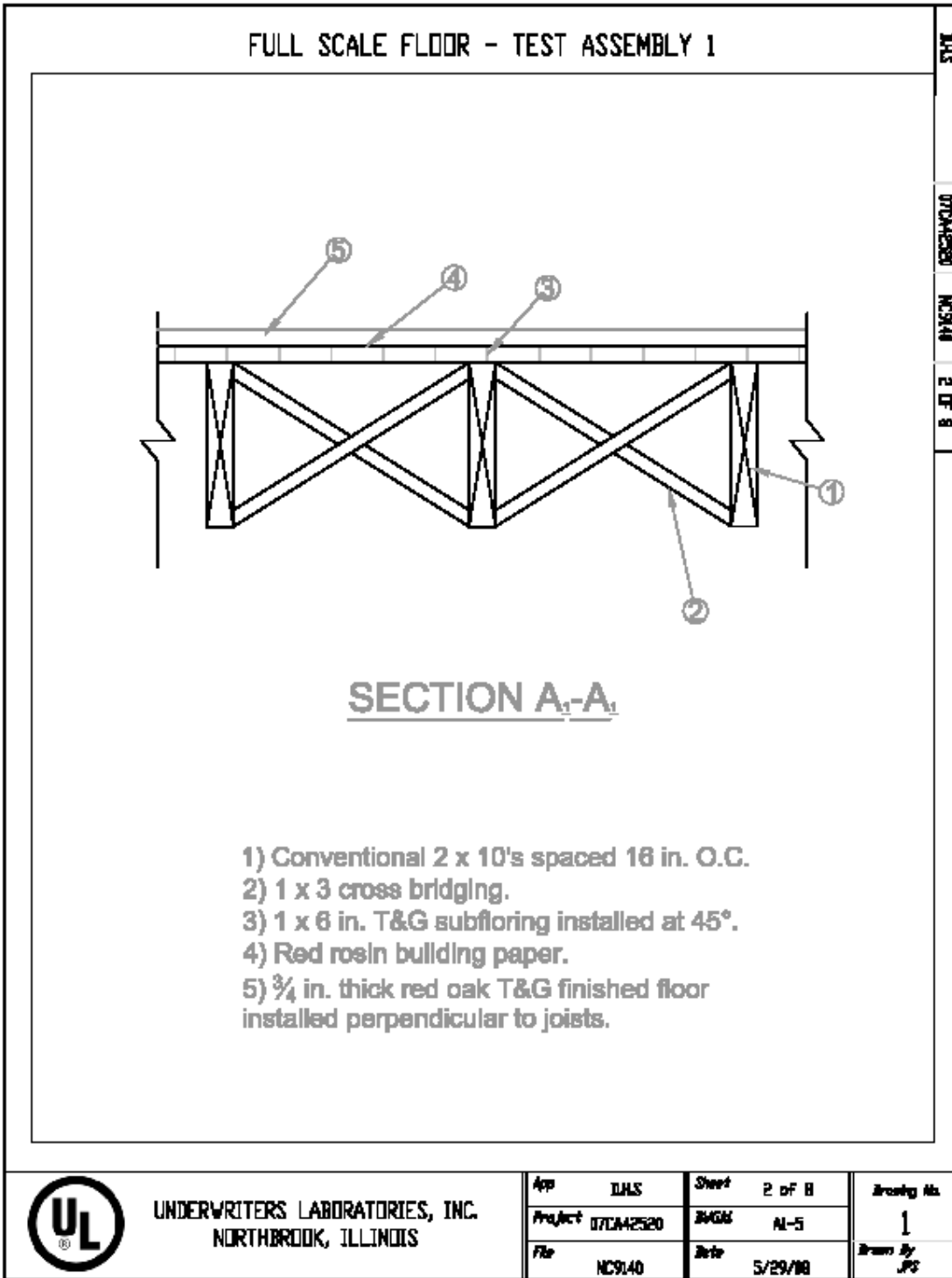

Figure A.1.2 – Construction Layout Section A₁-A₁.

Assembly No. 1

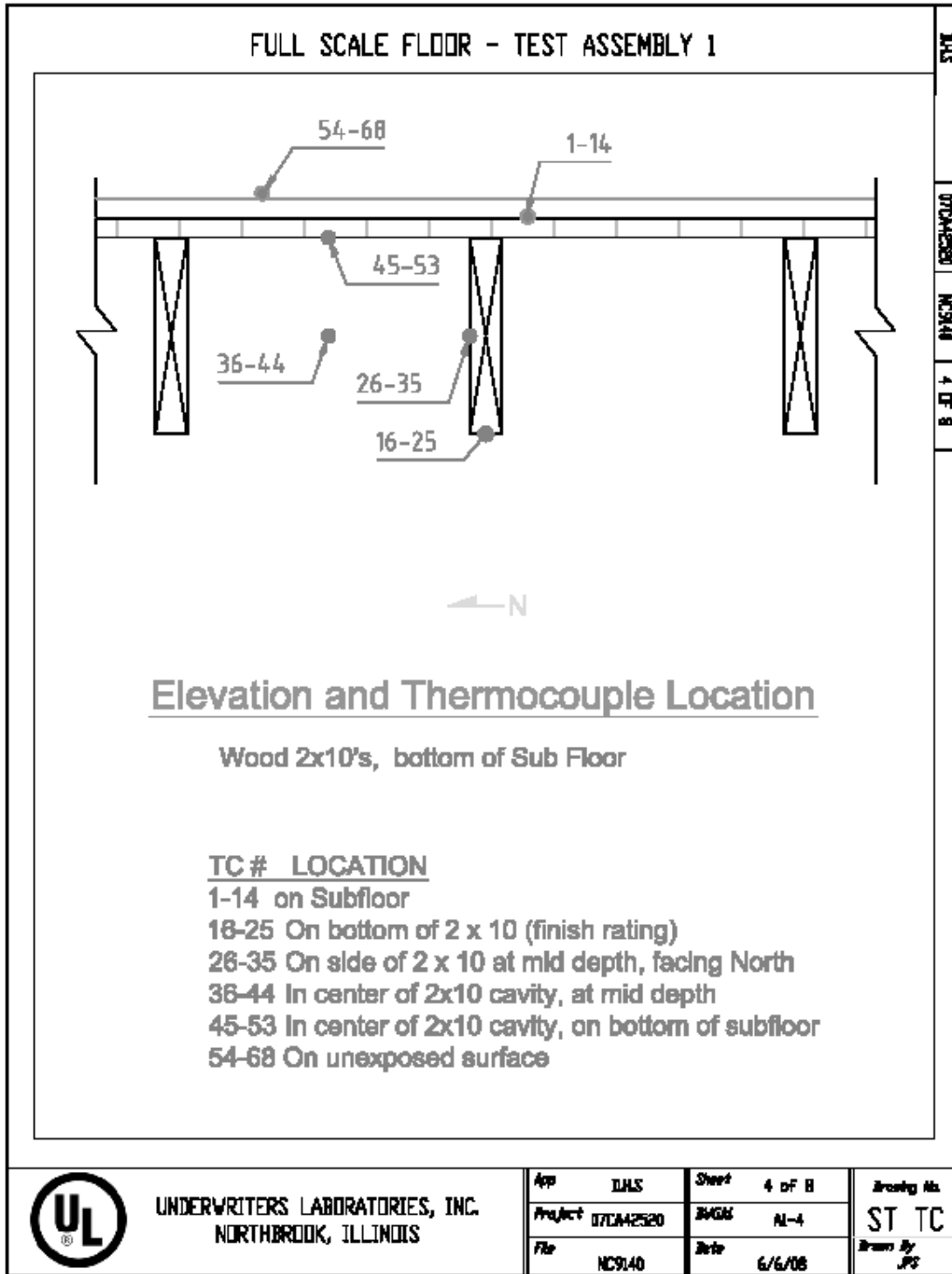

Figure A.1.3 – Thermocouple Locations - Elevation.

Assembly No. 1

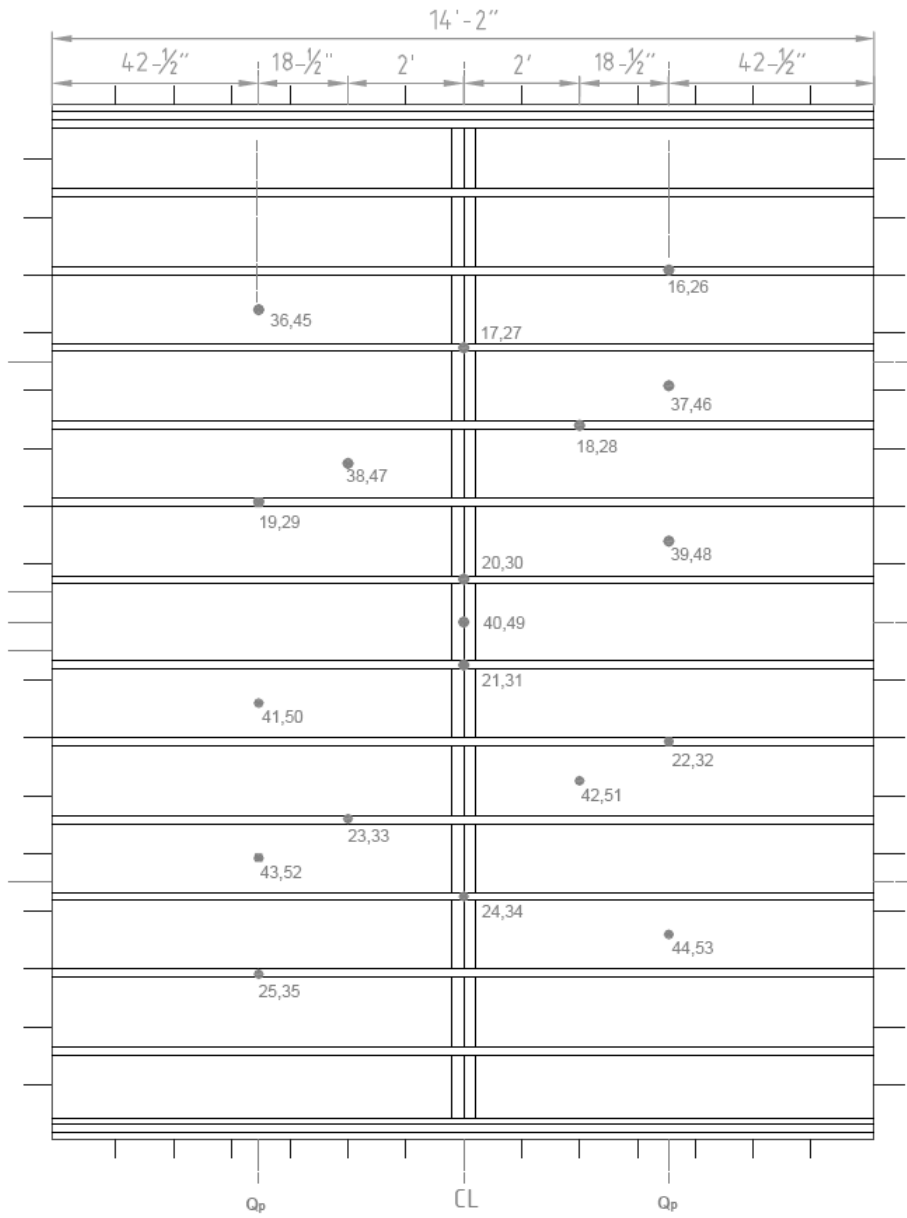

Figure A.1.4 – Thermocouple Locations on Wood Members.

Assembly No. 1

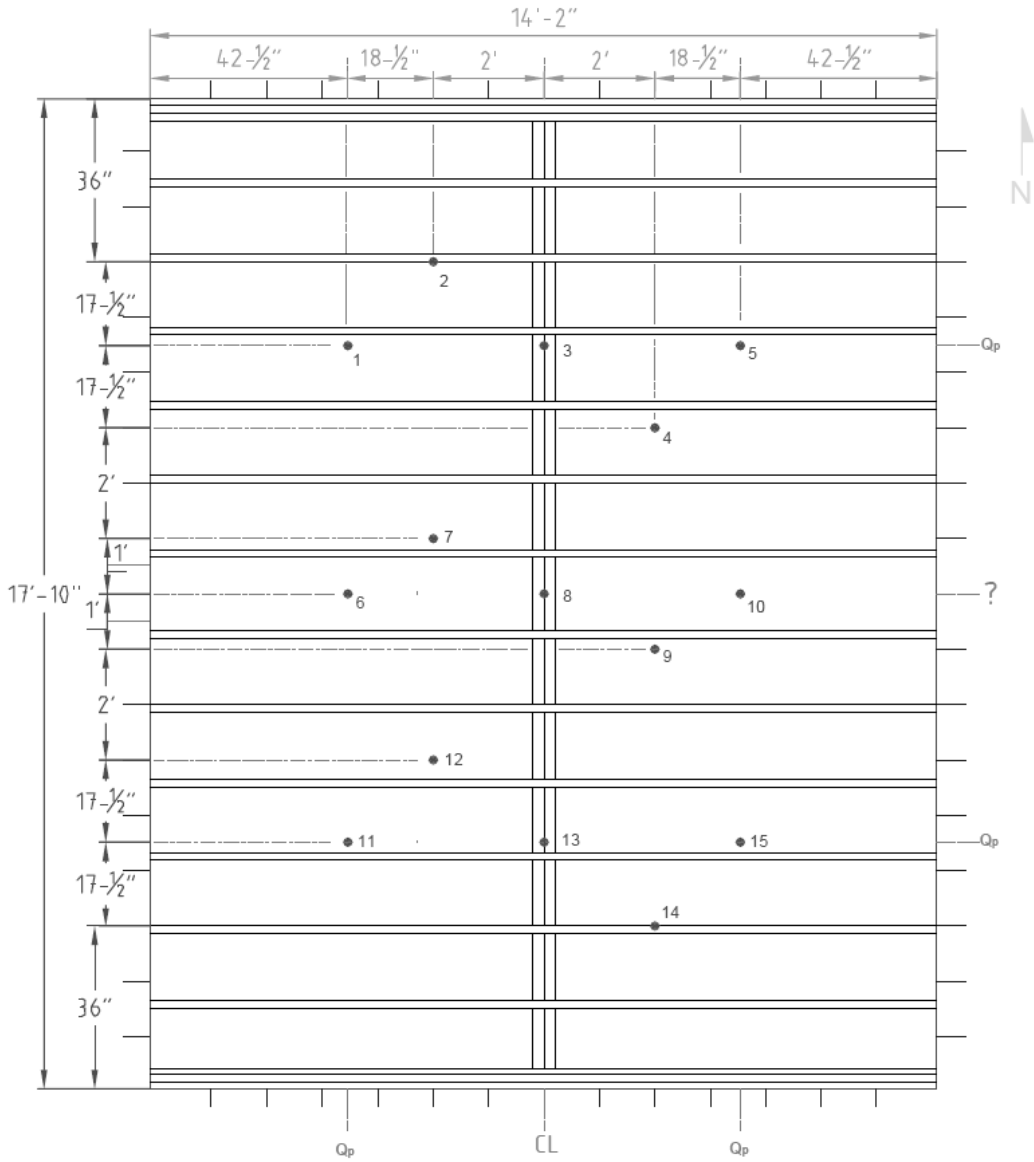

Figure A.1.5 – Thermocouple Locations on Subfloor.

Assembly No. 1

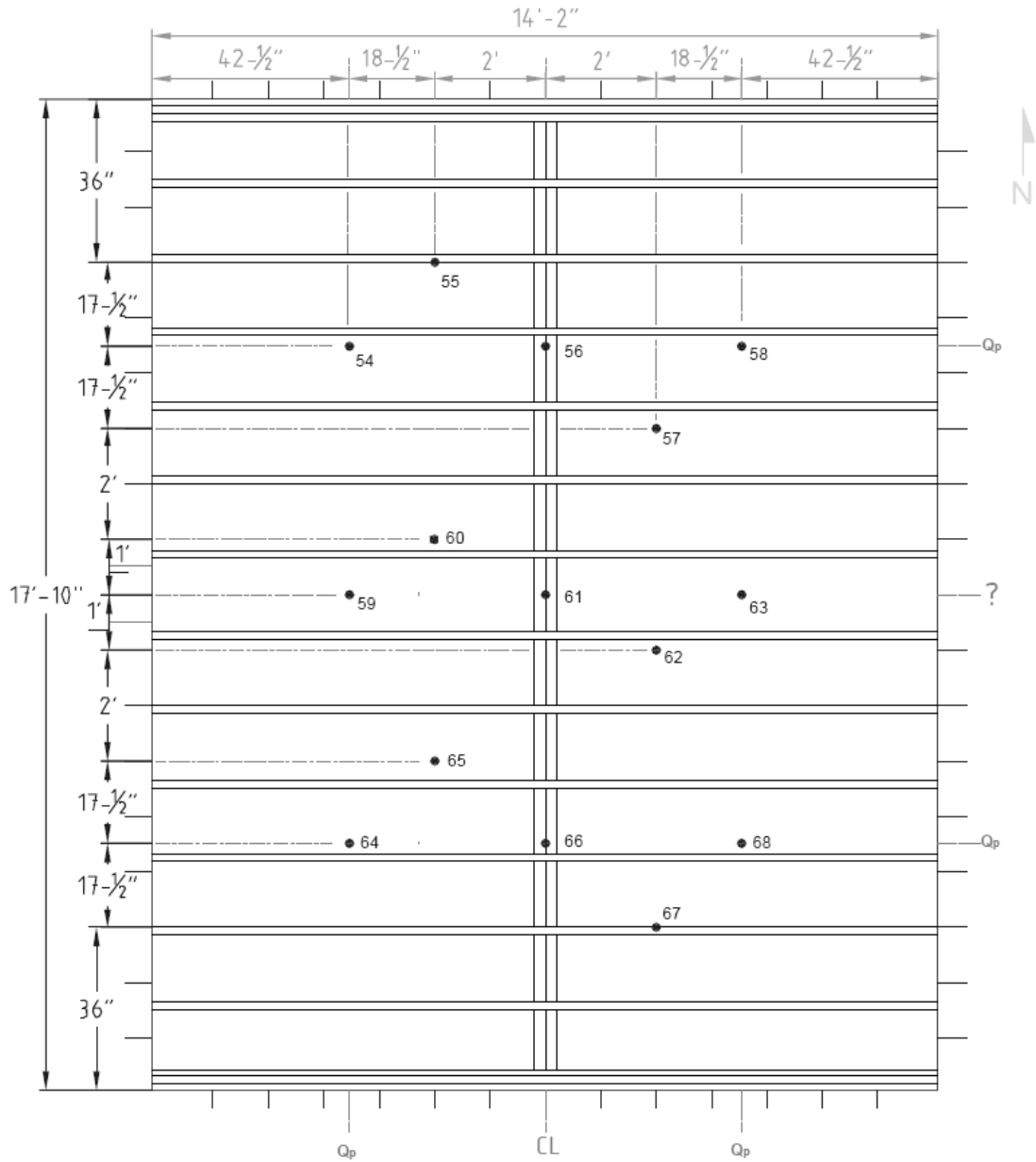

Figure A.1.6 – Thermocouple Locations on Unexposed Surface.

Assembly No. 1

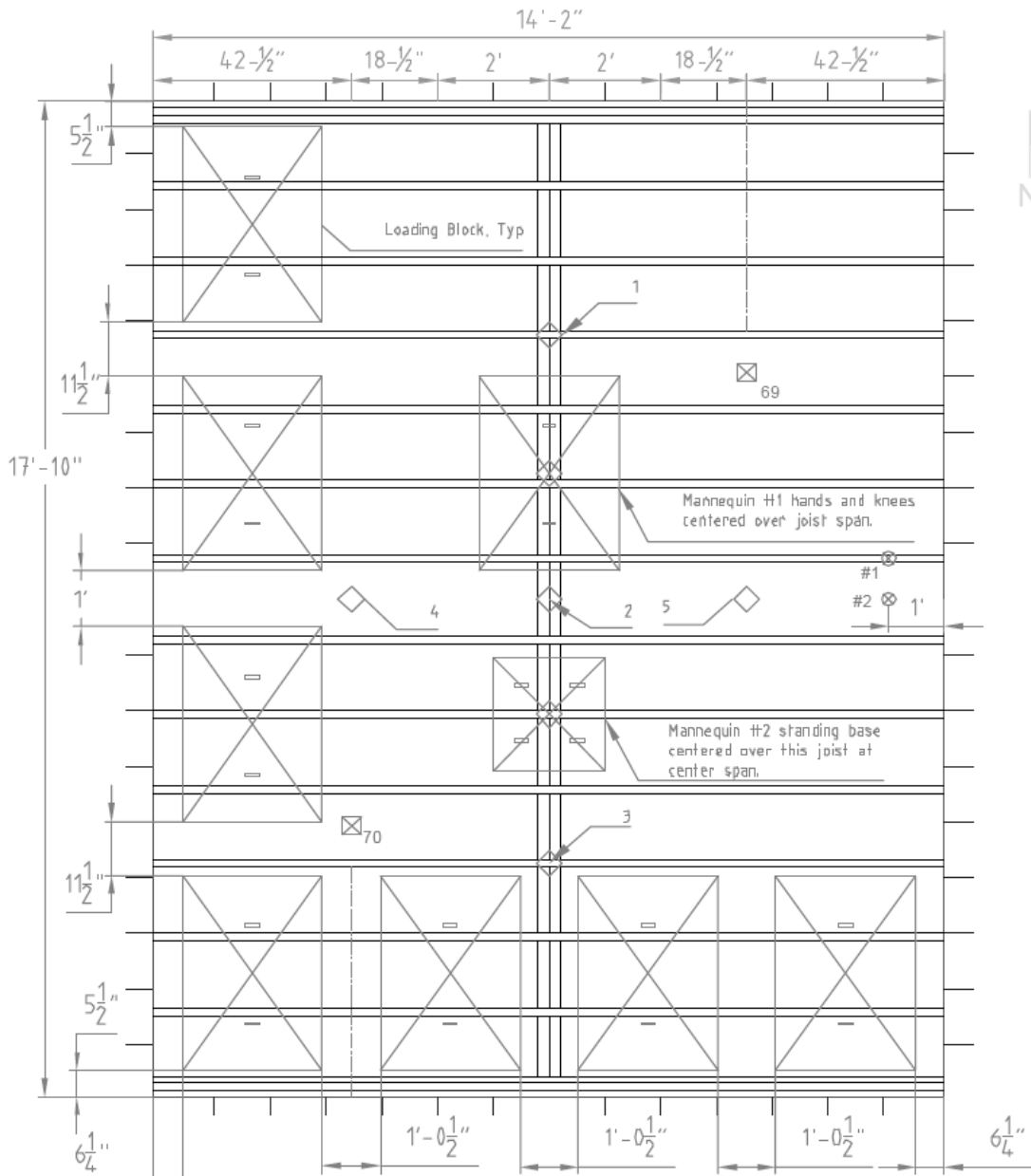

Figure A.1.7 – Loading and Instrumentation Layout (See Figure A.1.8).

Assembly No. 1**Deflection Tranducers:** 

- 1 - Along E-W Centerline, North Quarter-point.
- 2 - Along E-W Centerline, Center-point.
- 3 - Along E-W Centerline, South Quarter-point.
- 4 - Along N-S Centerline, East Quarter-point.
- 5 - Along N-S Centerline, West Quarter-point.

Accelerometers: 

- 1- Over Joist, 12 in. from East edge of assembly.
- 2- Over Center of Span, 12 in. from East edge of assembly.

Audio Recordings: (Not Shown)

- 1 - Mannequin No. 1 (Hands & Knees)
- 2 - Mannequin No. 2 (Standing)

Video Camera Recordings: (Not Shown)

- Channel 1409 - floor level view from northeast corner
- Channel 1411 - IR camera from curing cell roof east center
- Channel 1412 - furnace camera from northwest corner
- Channel 1416 - overhead from east center of assembly
- Channel 1413 - overhead from south west half of assembly
- Channel 1415 - overhead from south east half of assembly
- Channel 1502 - overhead from west north half of assembly
- Channel 1503 - overhead from west south half of assembly

Figure A.1.8 – Loading and Instrumentation Key

Assembly No. 2

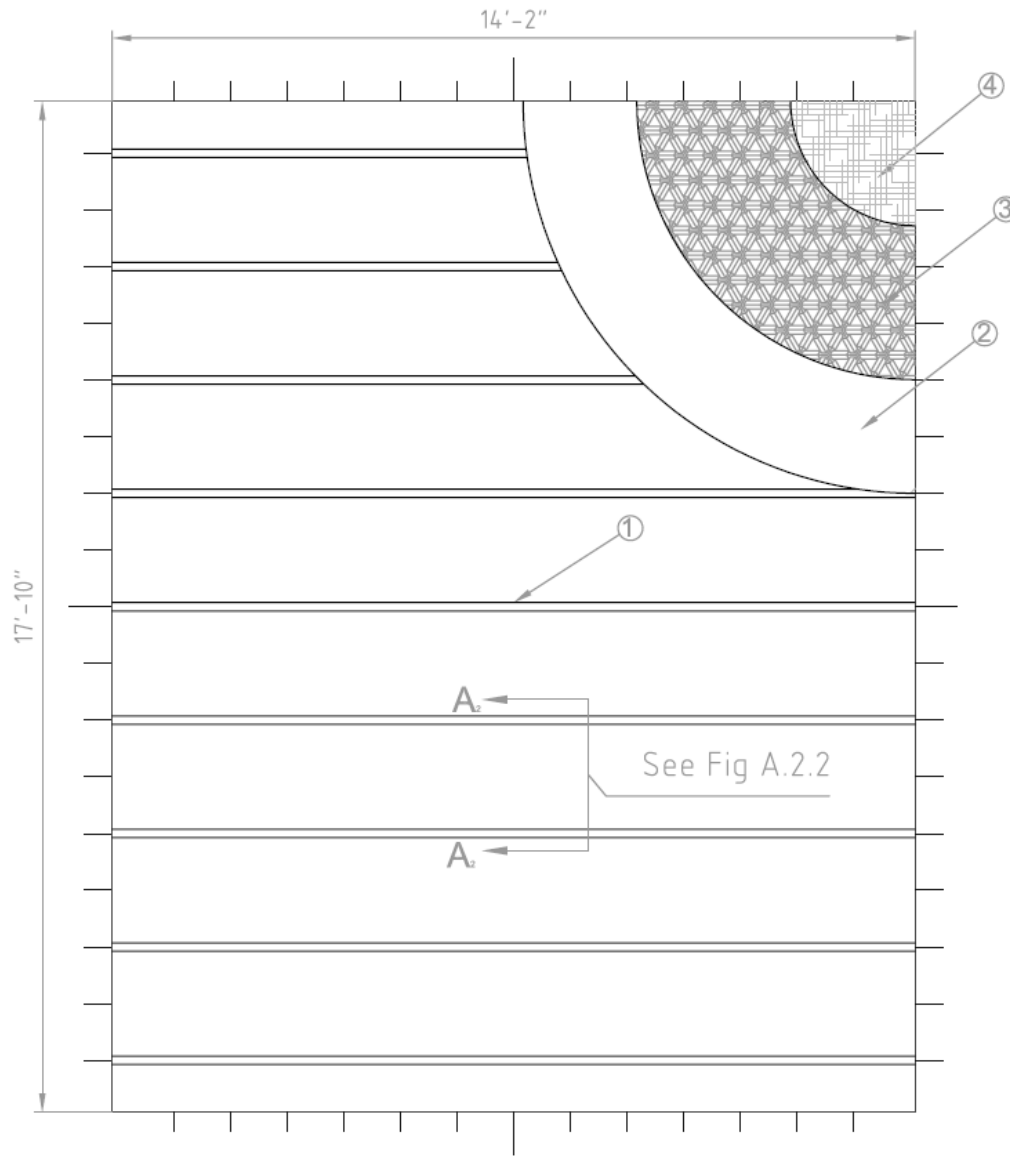

Figure A.2.1 – Construction Layout

Assembly No. 2

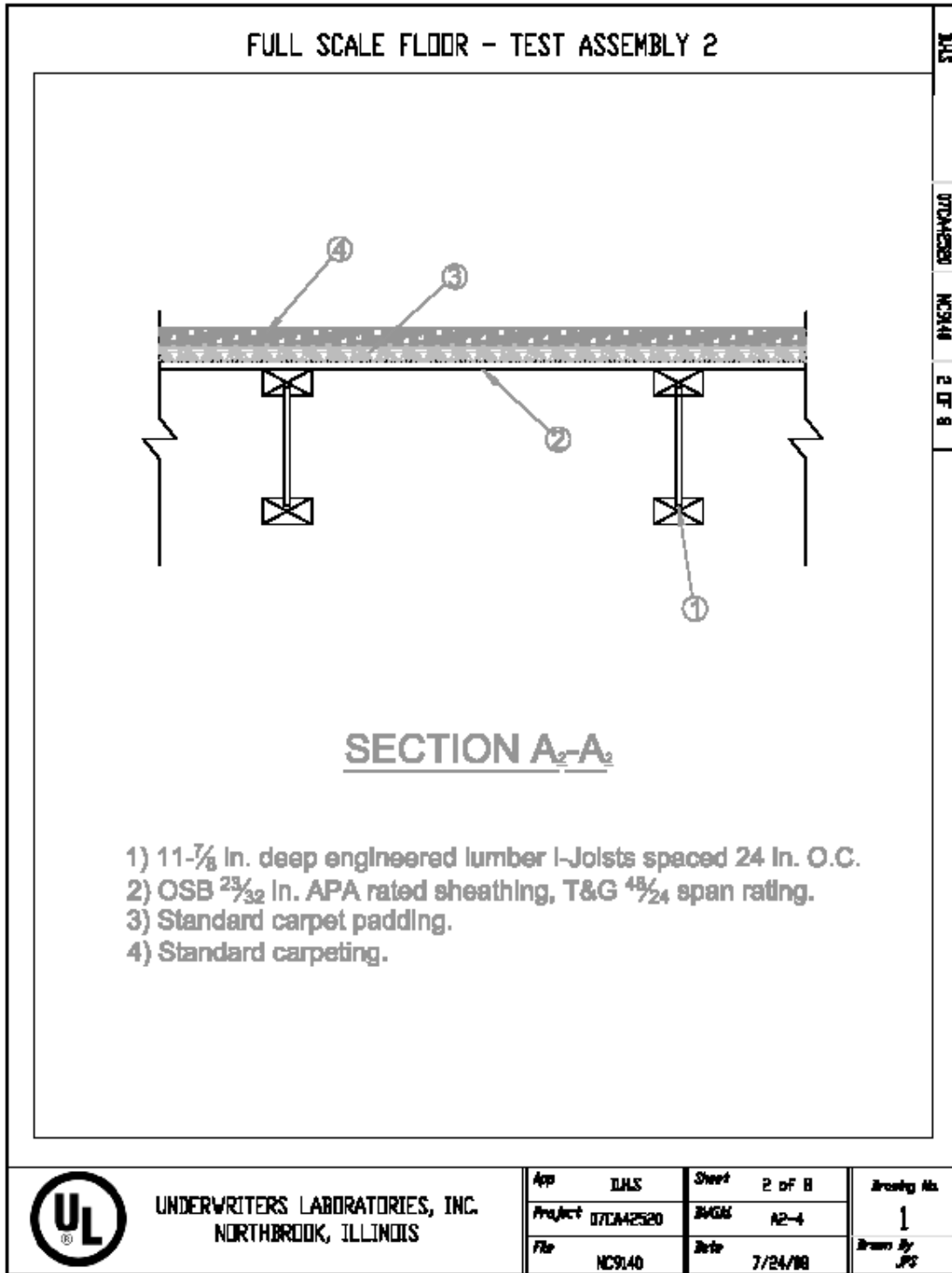

Figure A.2.2 – Construction Layout Section A₂-A₂.

Assembly No. 2

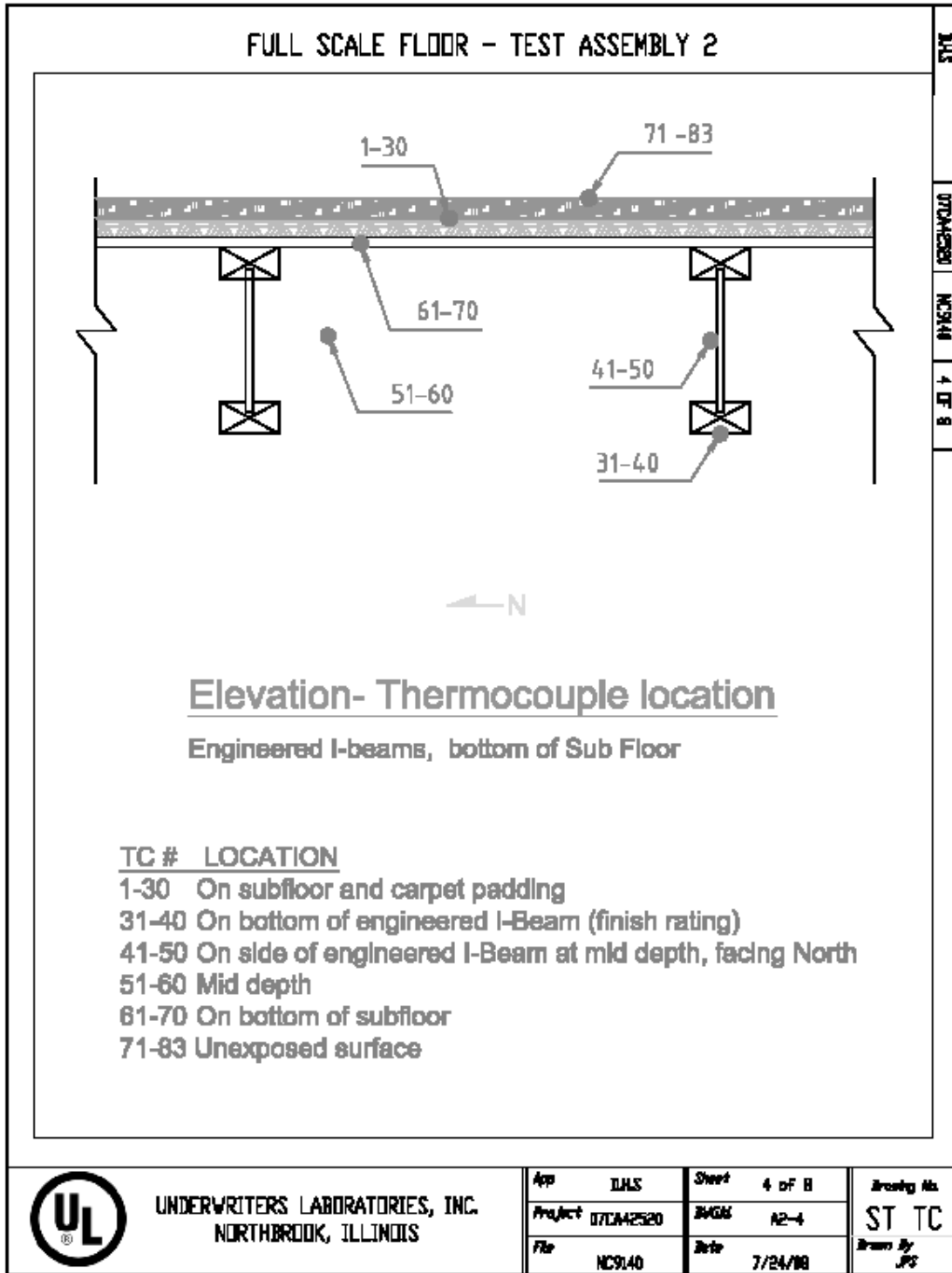

Figure A.2.3 – Thermocouple Locations - Elevation.

Assembly No. 2

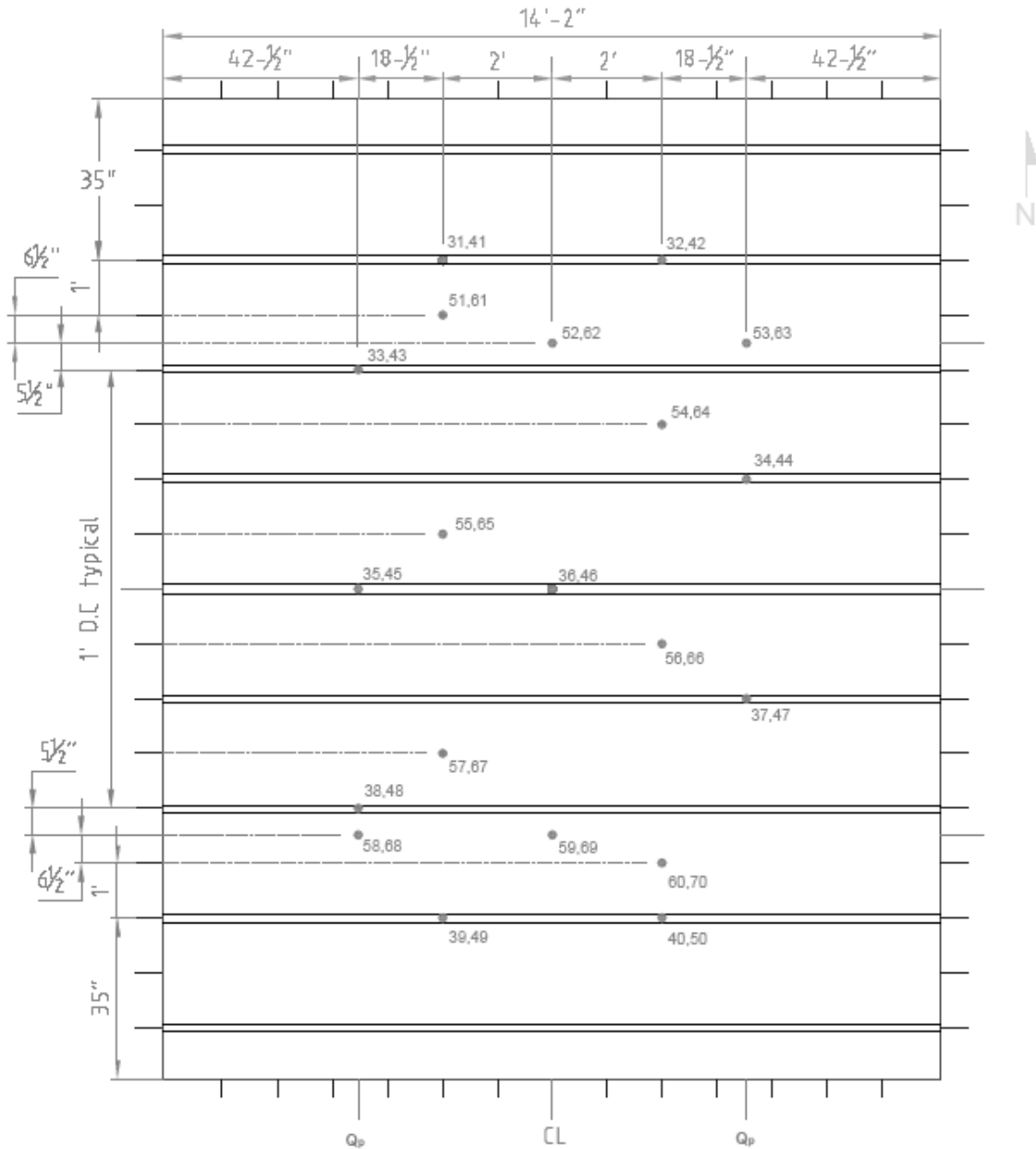

Figure A.2.4 – Thermocouple Locations on Wood Members.

Assembly No. 2

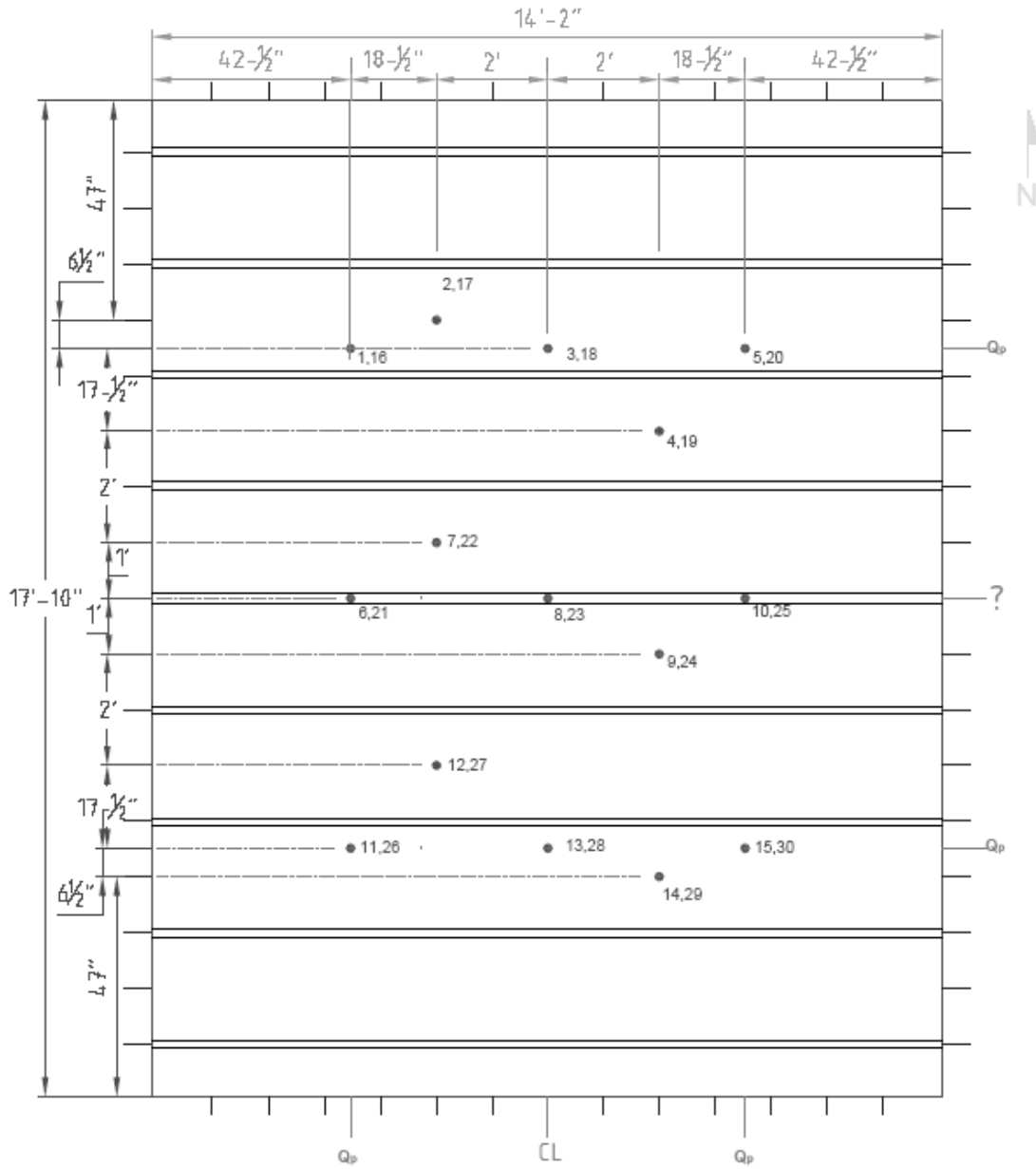

Figure A.2.5 – Thermocouple Locations on Subfloor and Carpet Padding.

Assembly No. 2

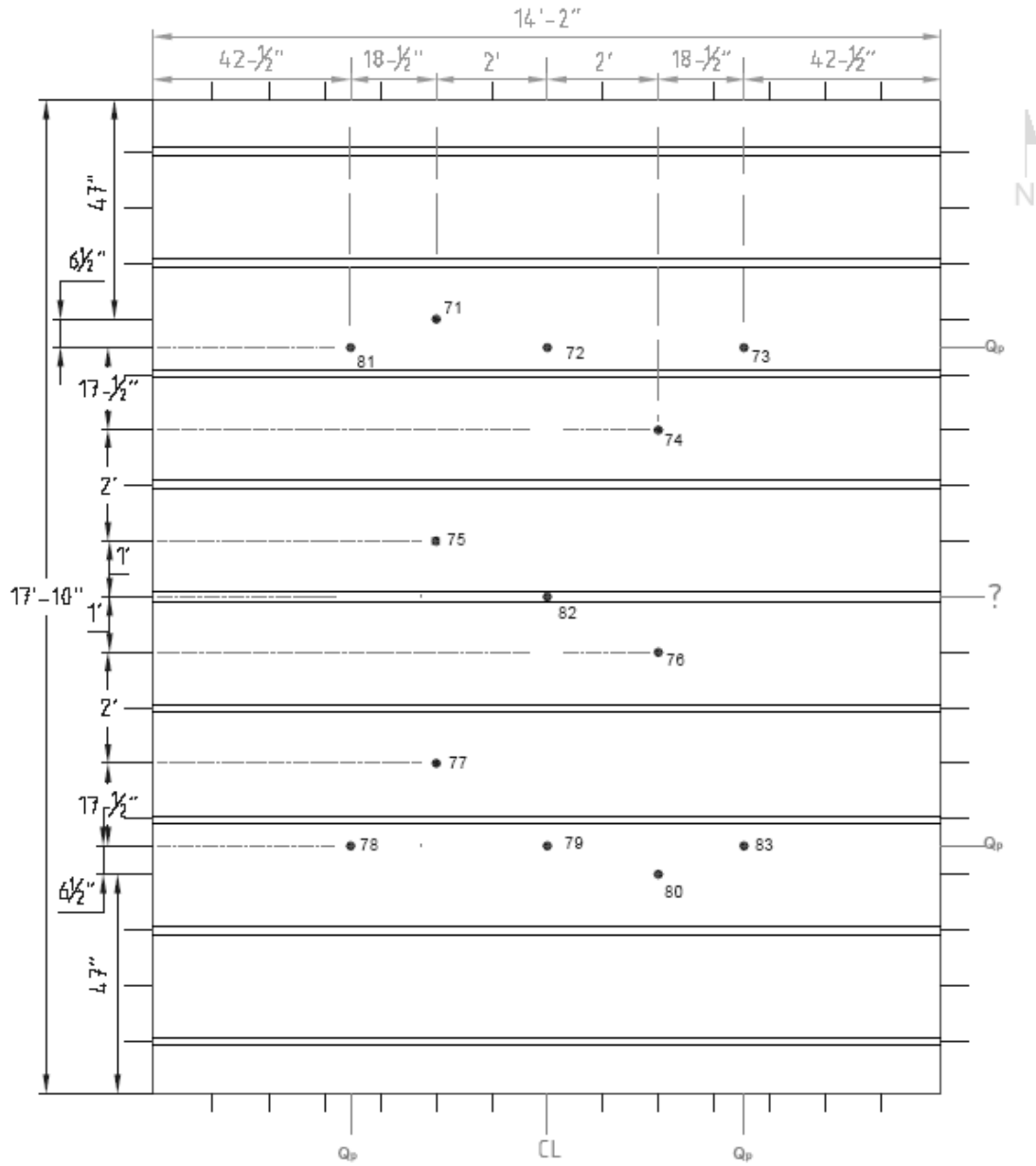

Figure A.2.6 – Thermocouple Locations on Unexposed Surface.

Assembly No. 2

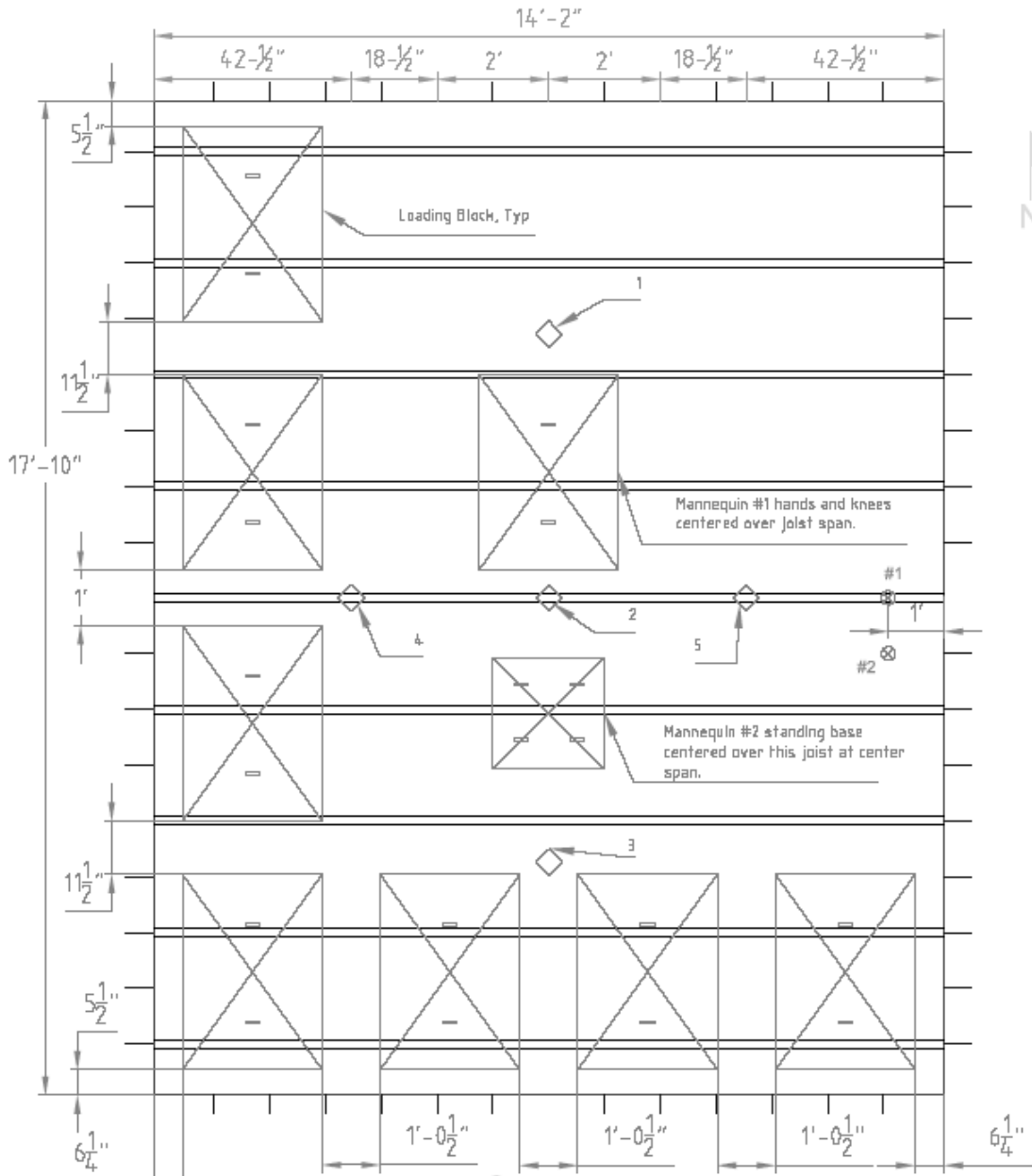

Figure A.2.7 – Loading and Instrumentation Layout (See Figure A.2.8).

Assembly No. 2**Deflection Transducers:**

- 1 - Along E-W Centerline, North Quarter-point.
- 2 - Along E-W Centerline, Center-point.
- 3 - Along E-W Centerline, South Quarter-point.
- 4 - Along N-S Centerline, East Quarter-point.
- 5 - Along N-S Centerline, West Quarter-point.

Accelerometers:

- 1- Over Joist, 12 in. from East edge of assembly.
- 2- Over Center of Span, 12 in. from East edge of assembly.

Audio Recordings: (Not Shown)

- 1 - Mannequin No. 1 (Hands & Knees)
- 2 - Mannequin No. 2 (Standing)

Video Camera Recordings: (Not Shown)

- Channel 1409 - floor level view from northeast corner
- Channel 1411 - IR camera from curing cell roof east center
- Channel 1412 - furnace camera from northwest corner
- Channel 1416 - overhead from east center of assembly
- Channel 1413 - overhead from south west half of assembly
- Channel 1415 - overhead from south east half of assembly
- Channel 1502 - overhead from west north half of assembly
- Channel 1503 - overhead from west south half of assembly

Figure A.2.8 – Loading and Instrumentation Key

Assembly No. 3

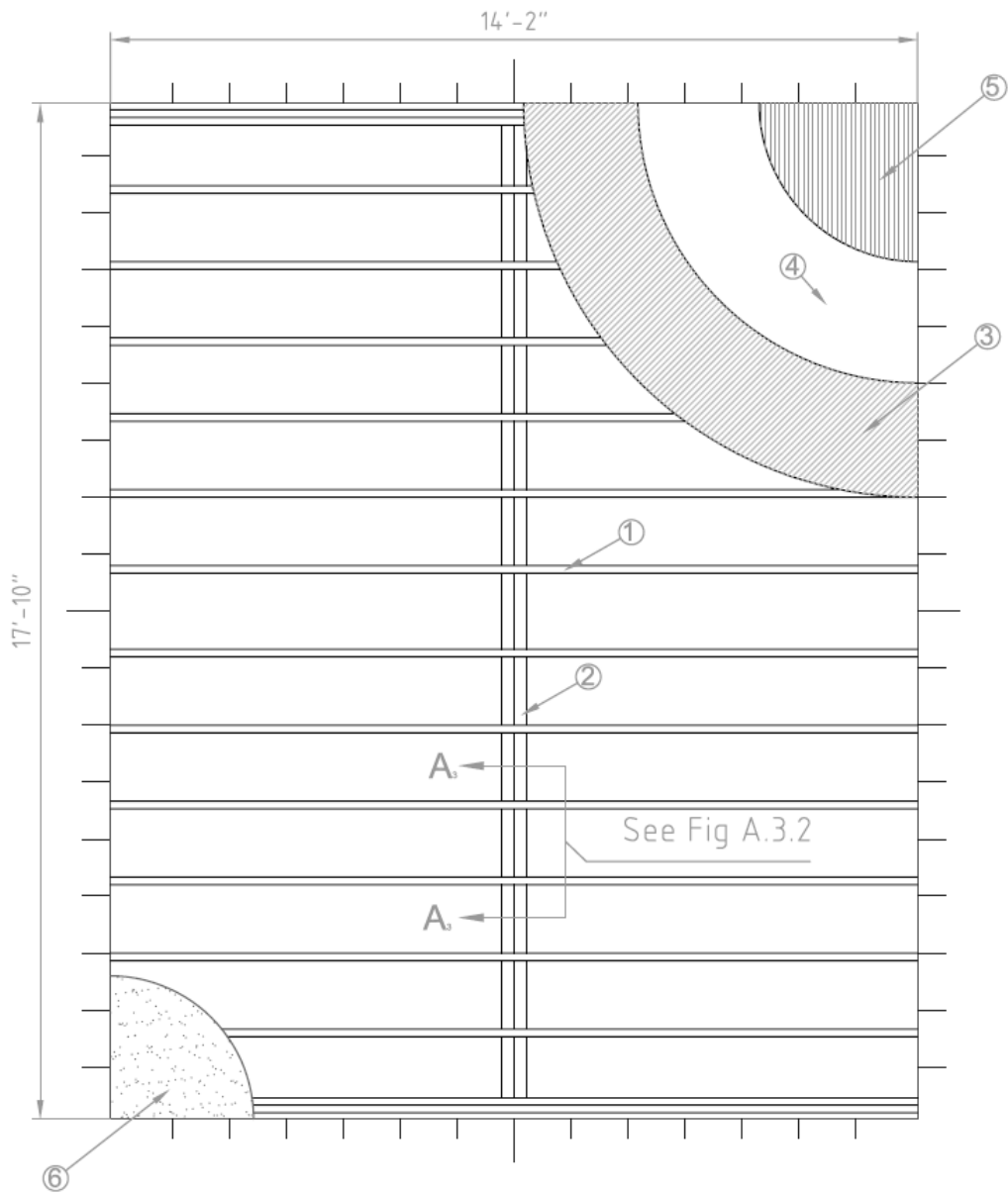

Figure A.3.1 – Construction Layout.

Assembly No. 3

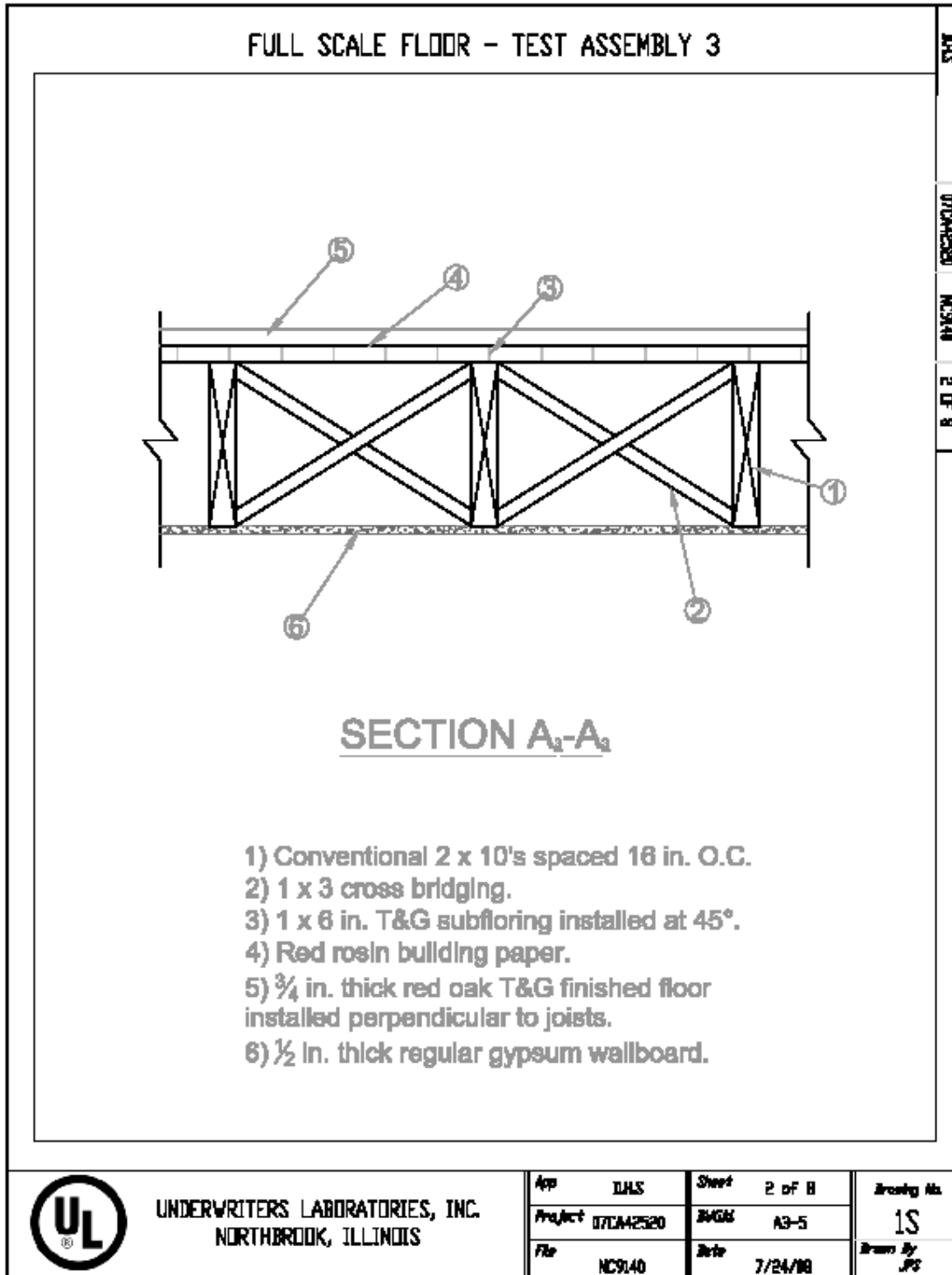

Figure A.3.2 – Construction Layout Section A₃-A₃.

Assembly No. 3

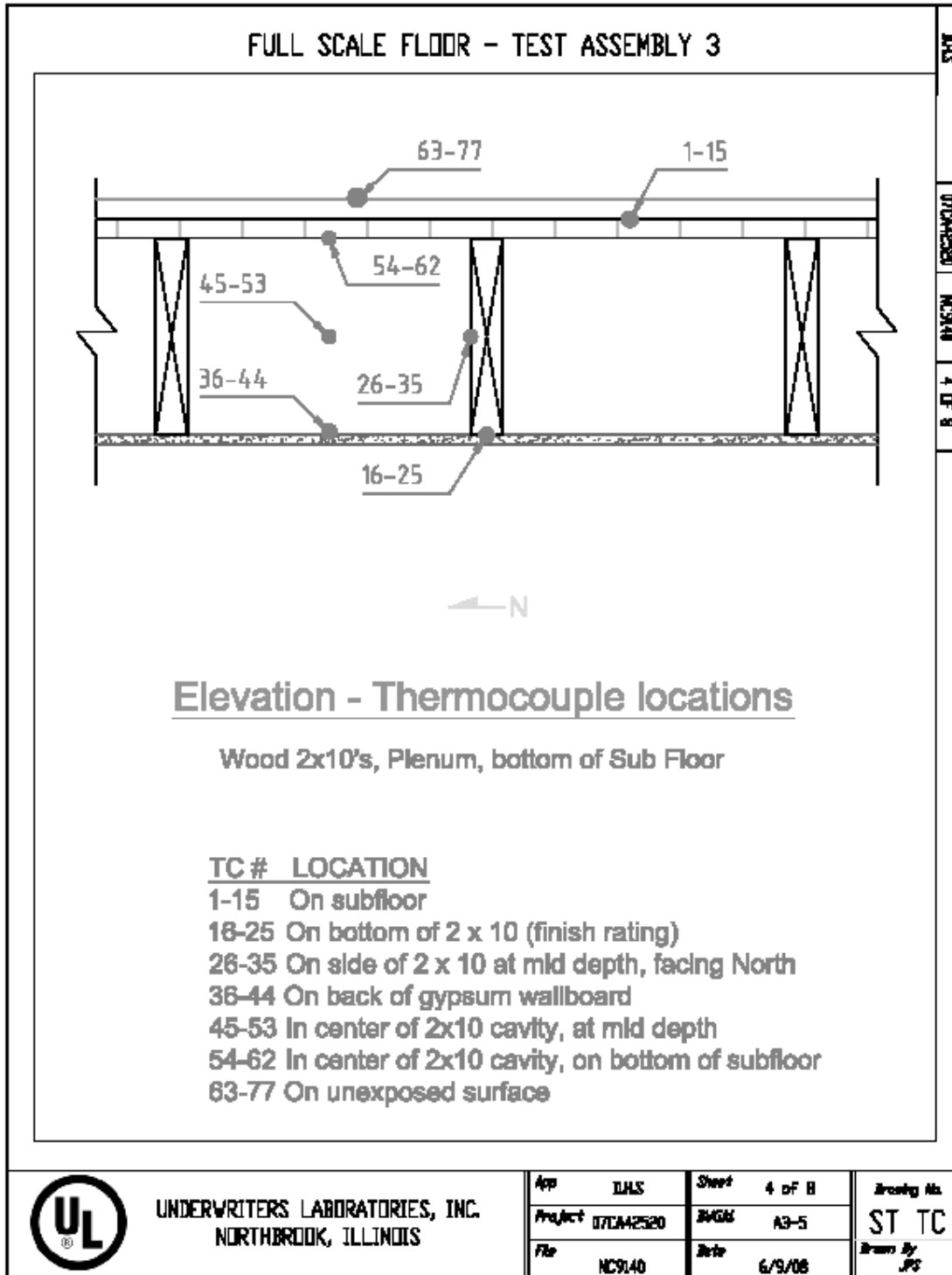

Figure A.3.3 – Thermocouple Locations - Elevation.

Assembly No. 3

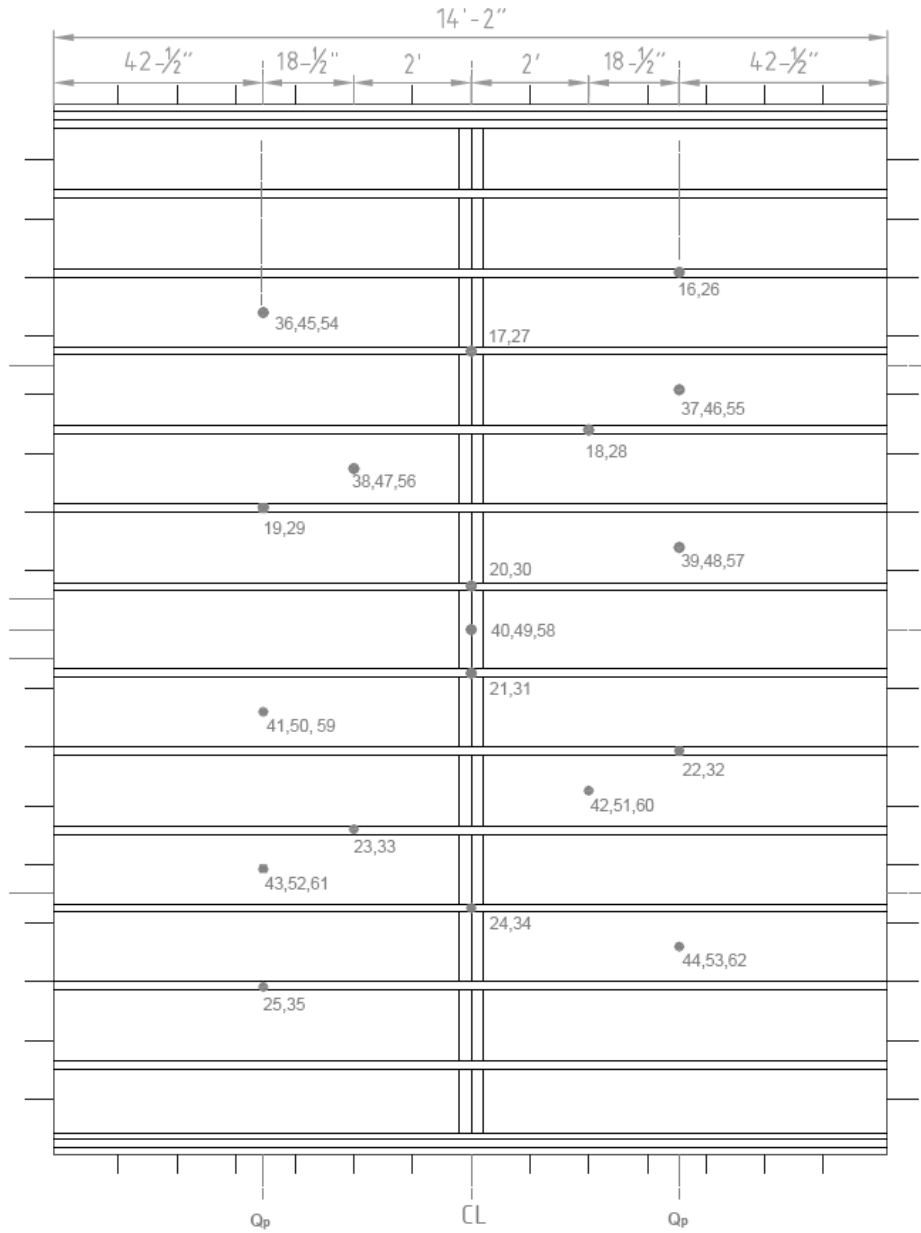

Figure A.3.4 – Thermocouple Locations on Wood Member.

Assembly No. 3

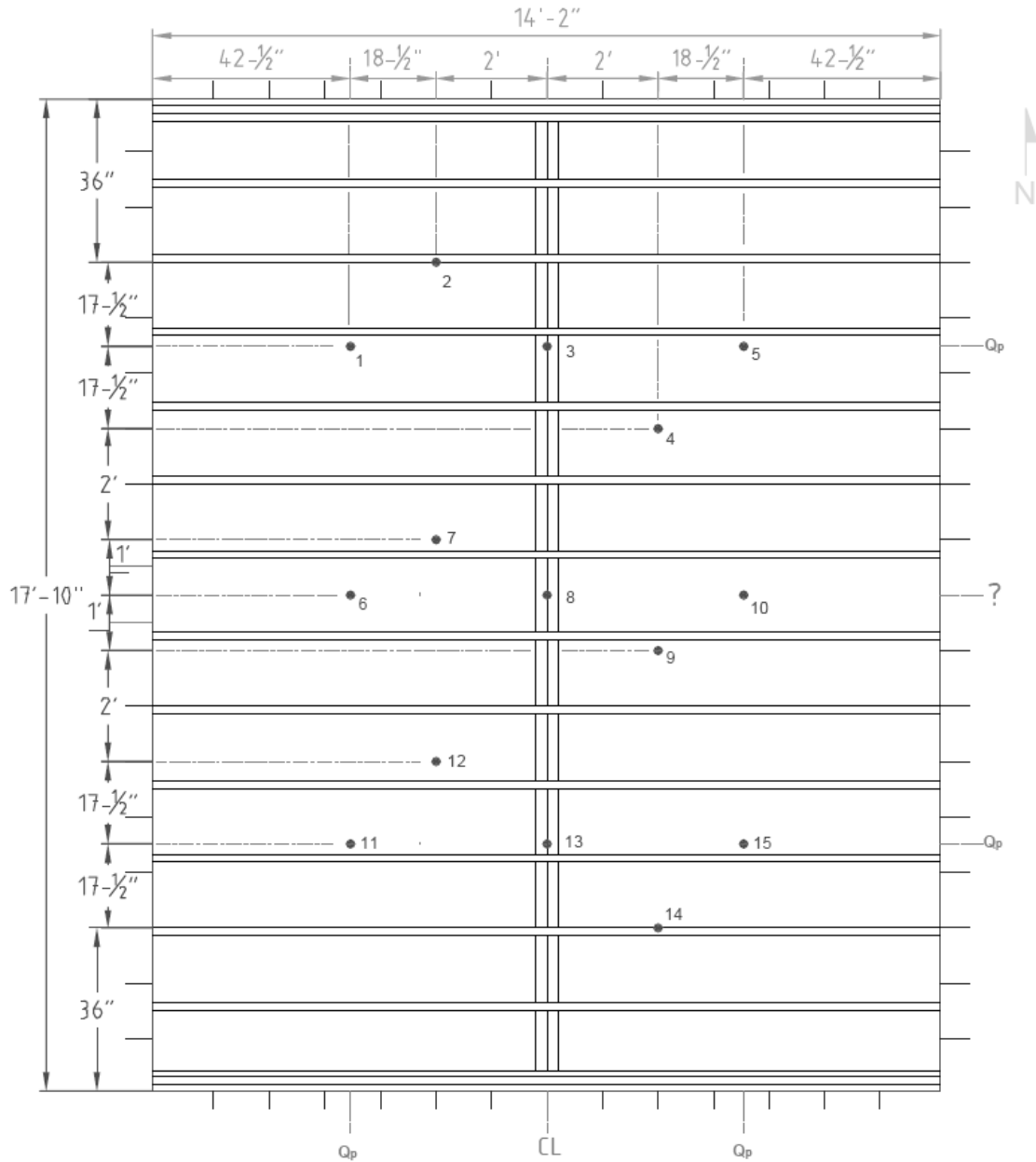

Figure A.3.5 – Thermocouple Locations on Subfloor.

Assembly No. 3

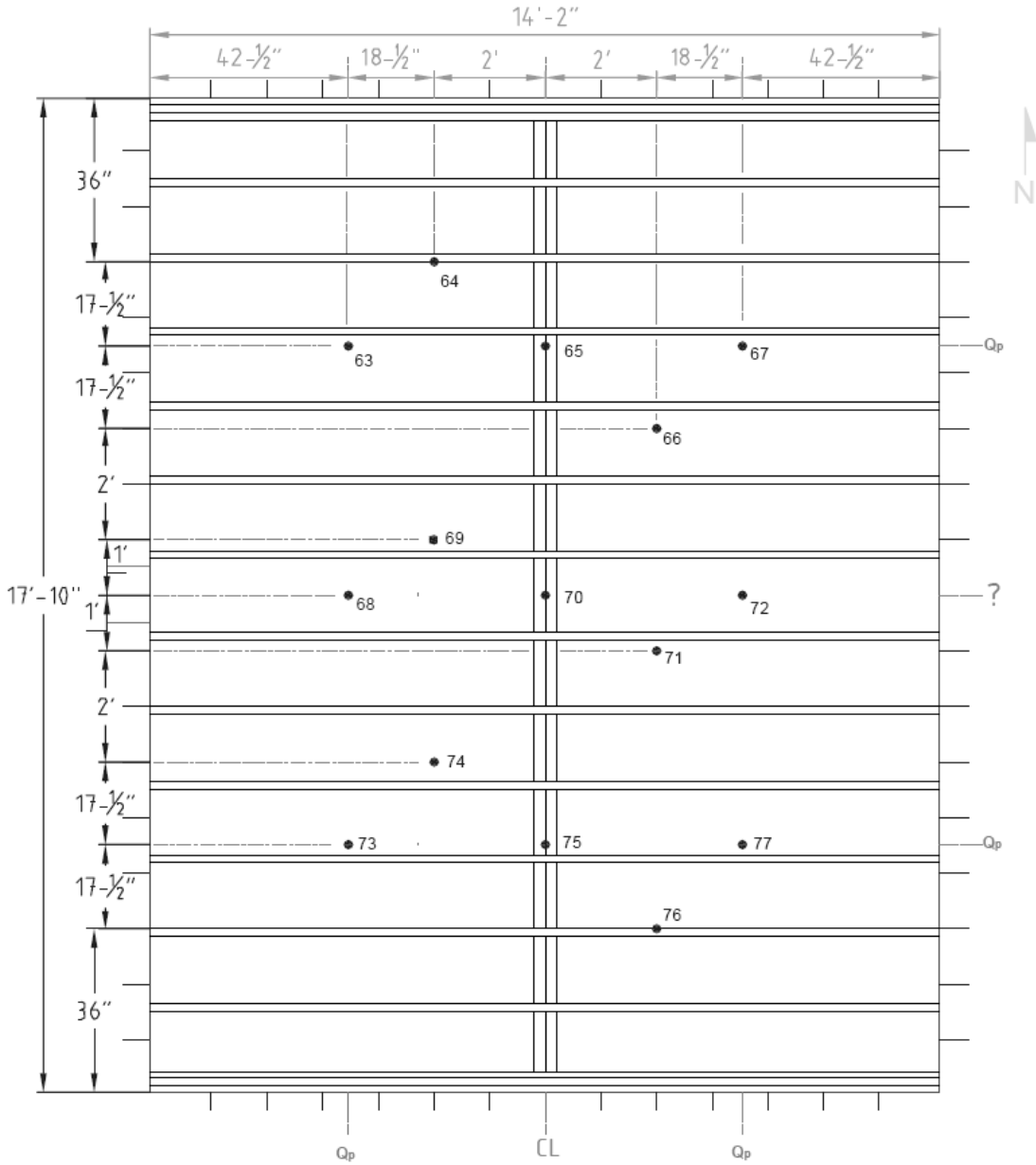

Figure A.3.6 – Thermocouple Locations on Unexposed Surface.

Assembly No. 3

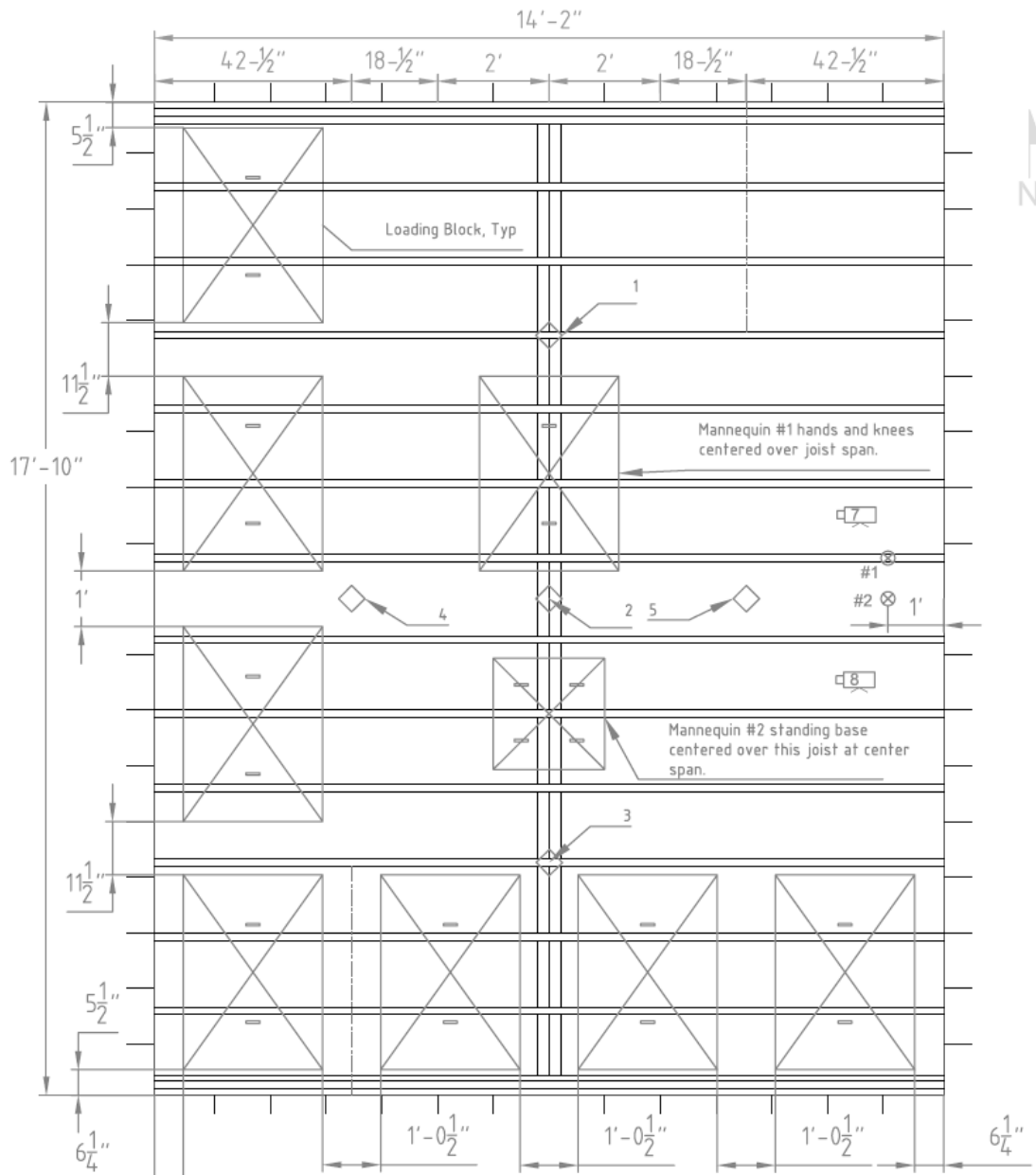

Figure A.3.7 – Loading and Instrumentation Layout (See Figure A.3.8).

Assembly No. 3**Deflection Transducers:** 

- 1 - Along E-W Centerline, North Quarter-point.
- 2 - Along E-W Centerline, Center-point.
- 3 - Along E-W Centerline, South Quarter-point.
- 4 - Along N-S Centerline, East Quarter-point.
- 5 - Along N-S Centerline, West Quarter-point.

Accelerometers: 

- 1- Over Joist, 12 in. from East edge of assembly.
- 2- Over Center of Span, 12 in. from East edge of assembly.

Audio Recordings: (Not Shown)

- 1 - Mannequin No. 1 (Hands & Knees)
- 2 - Mannequin No. 2 (Standing)

Video Camera Recordings: (Not Shown)

- Channel 1409 - floor level view from northeast corner
- Channel 1411 - IR camera from curing cell roof east center
- Channel 1412 - furnace camera from northwest corner
- Channel 1416 - overhead from east center of assembly
- Channel 1413 - overhead from south center of assembly
- Channel 1503 - overhead from west center of assembly

Video Camera Recordings: 

- Channel 1415 - internal camera east (installed in joist cavity 6 from north facing west - under kneeling mannequin #1.
- Channel 1502 - internal camera east (installed in joist cavity 8 from north facing west -under standing mannequin #2.

Furnace Pressure Probes: (Not Shown)

- 1 - located near plate thermocouple No. 78
- 2 - located near plate thermocouple No. 79

Oxygen Content : (Not Shown)

located in E exhaust duct.

Figure A.3.8 – Loading and Instrumentation Key

Assembly No. 4

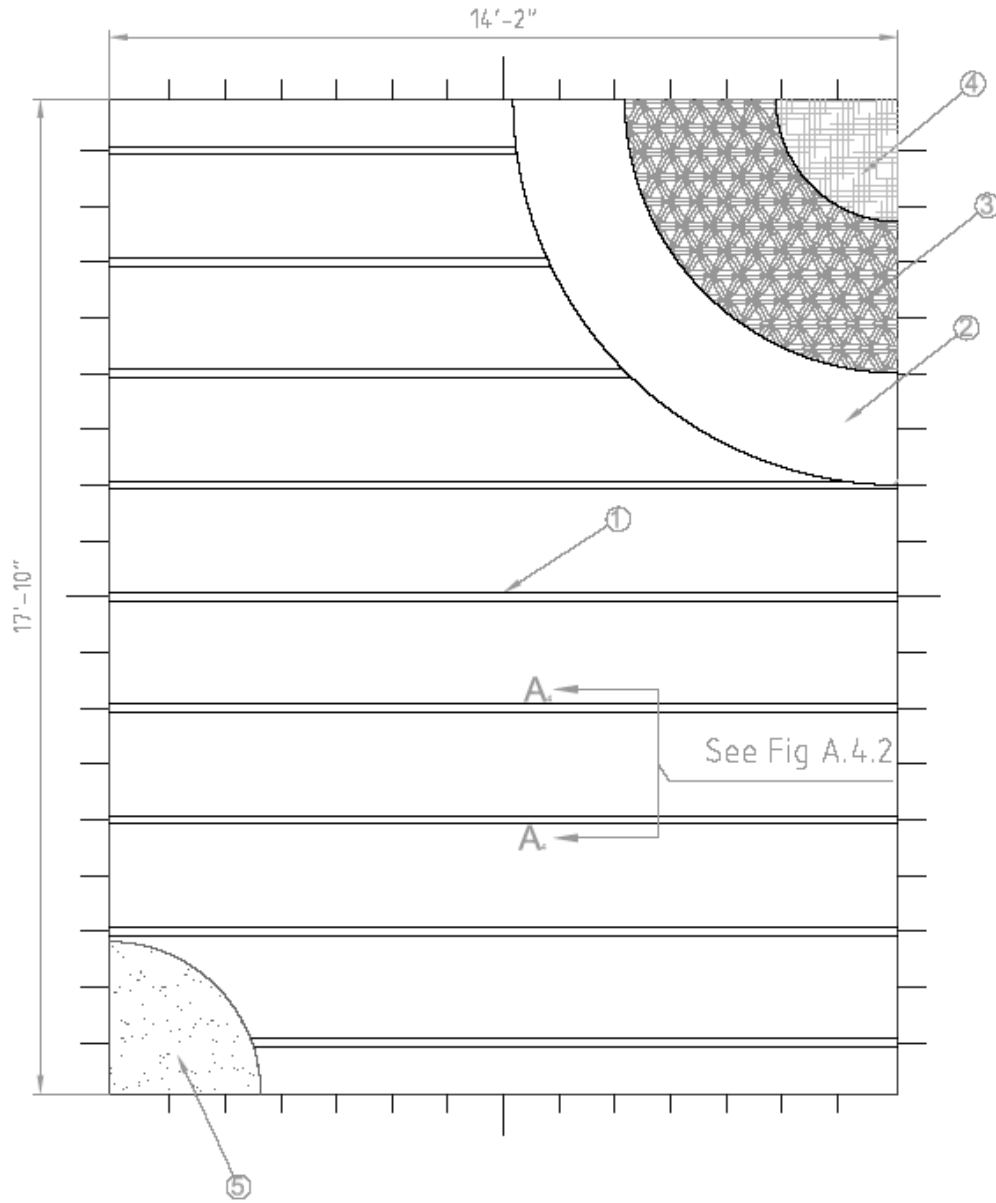

Figure A.4.1 – Construction Layout

Assembly No. 4

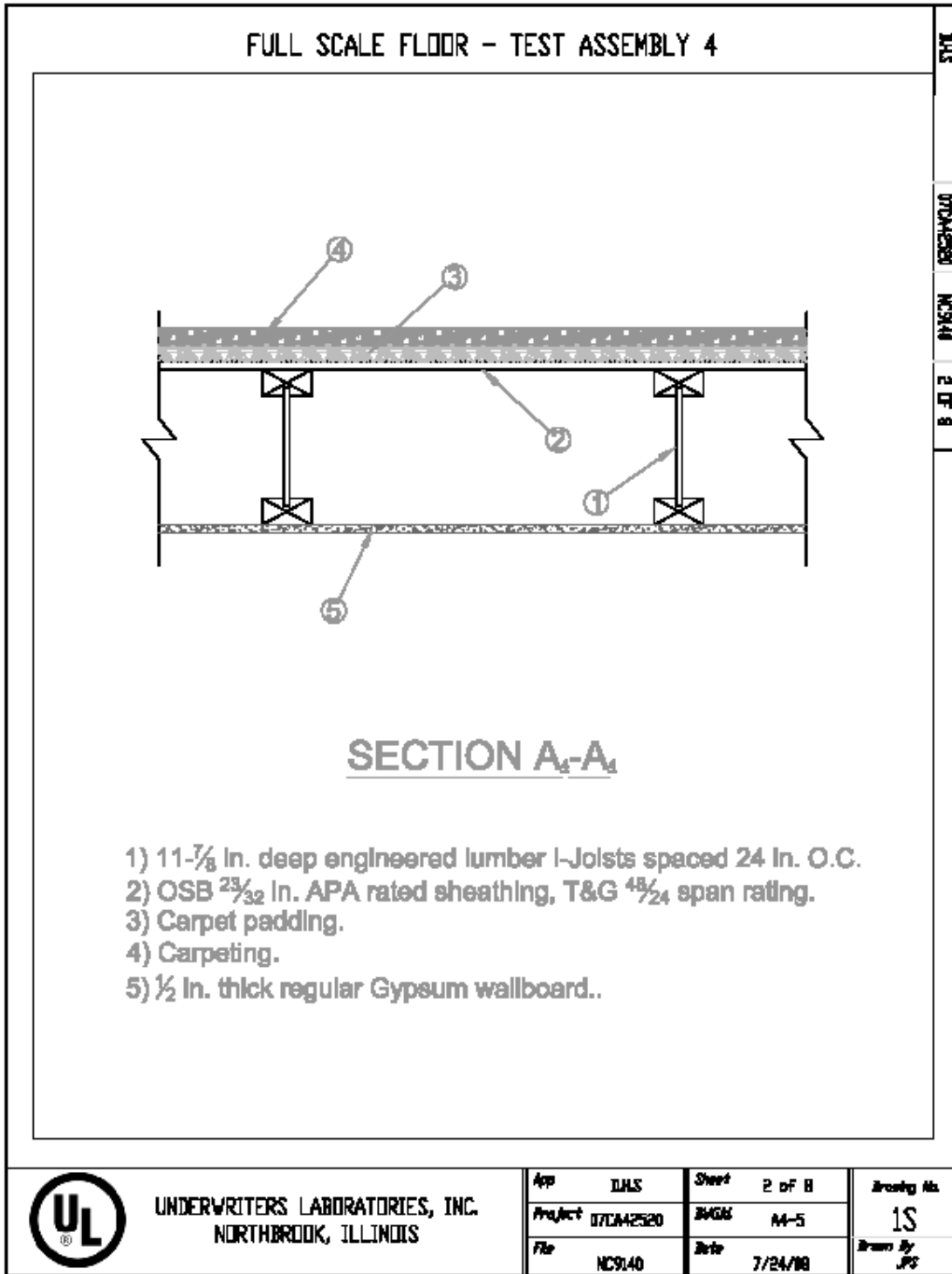

Figure A.4.2 – Construction Layout Section A₄-A₄.

Assembly No. 4

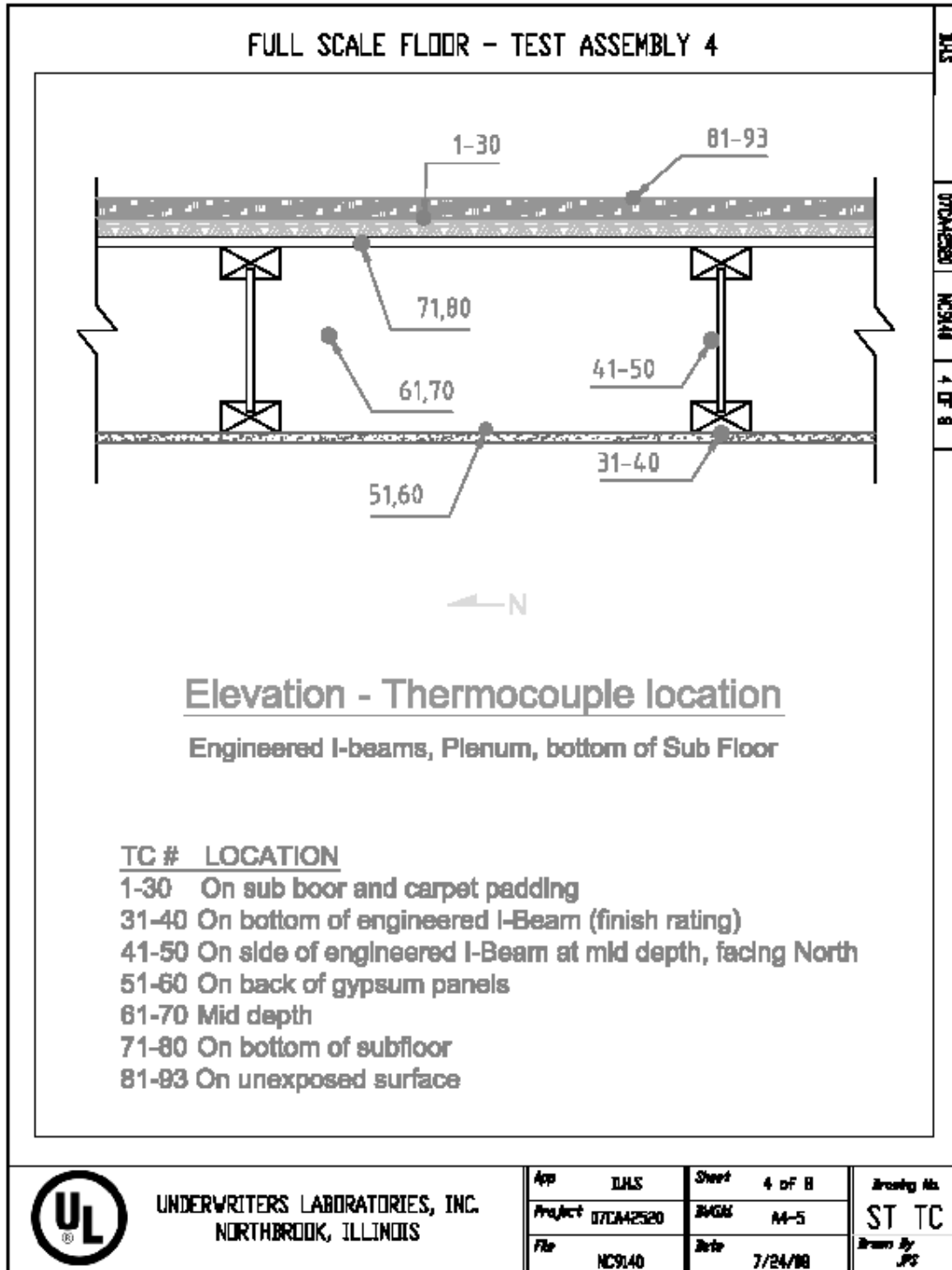

Figure A.4.3 – Thermocouple Locations - Elevation.

Assembly No. 4

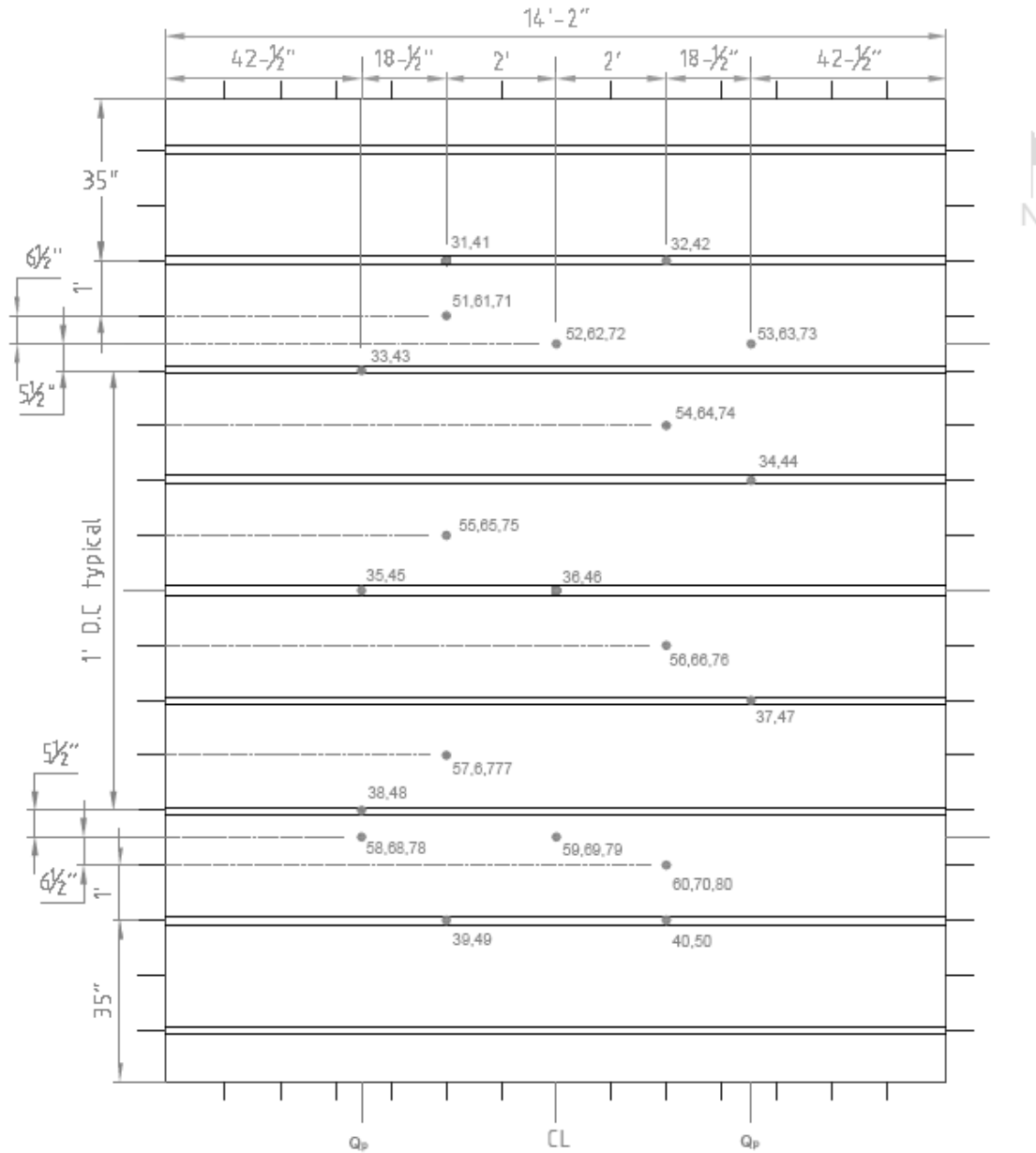

Figure A.4.4 – Thermocouple Locations on Wood Members.

Assembly No. 4

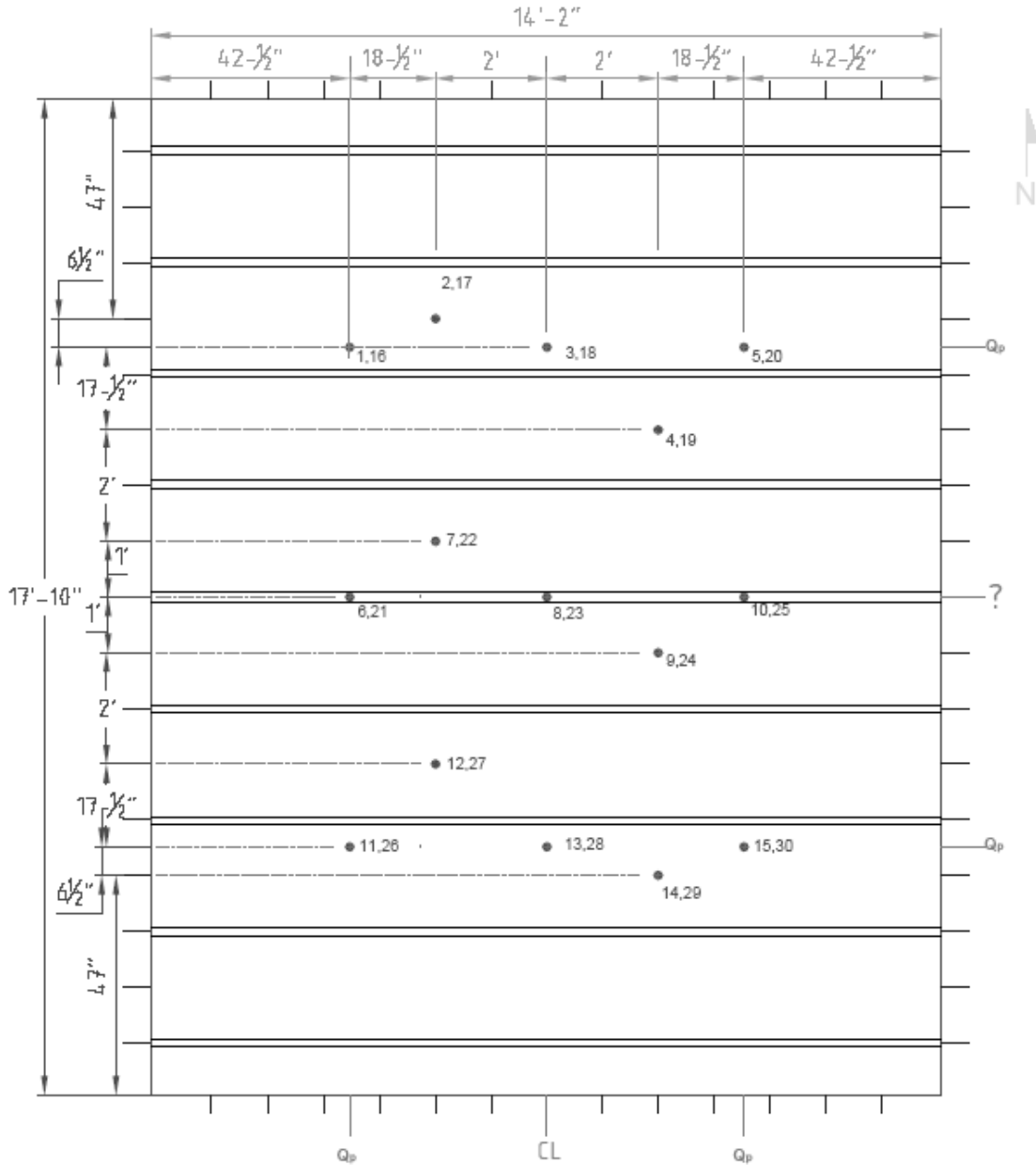

Figure A.4.5 – Thermocouple Locations on Subfloor and Carpet Padding.

Assembly No. 4

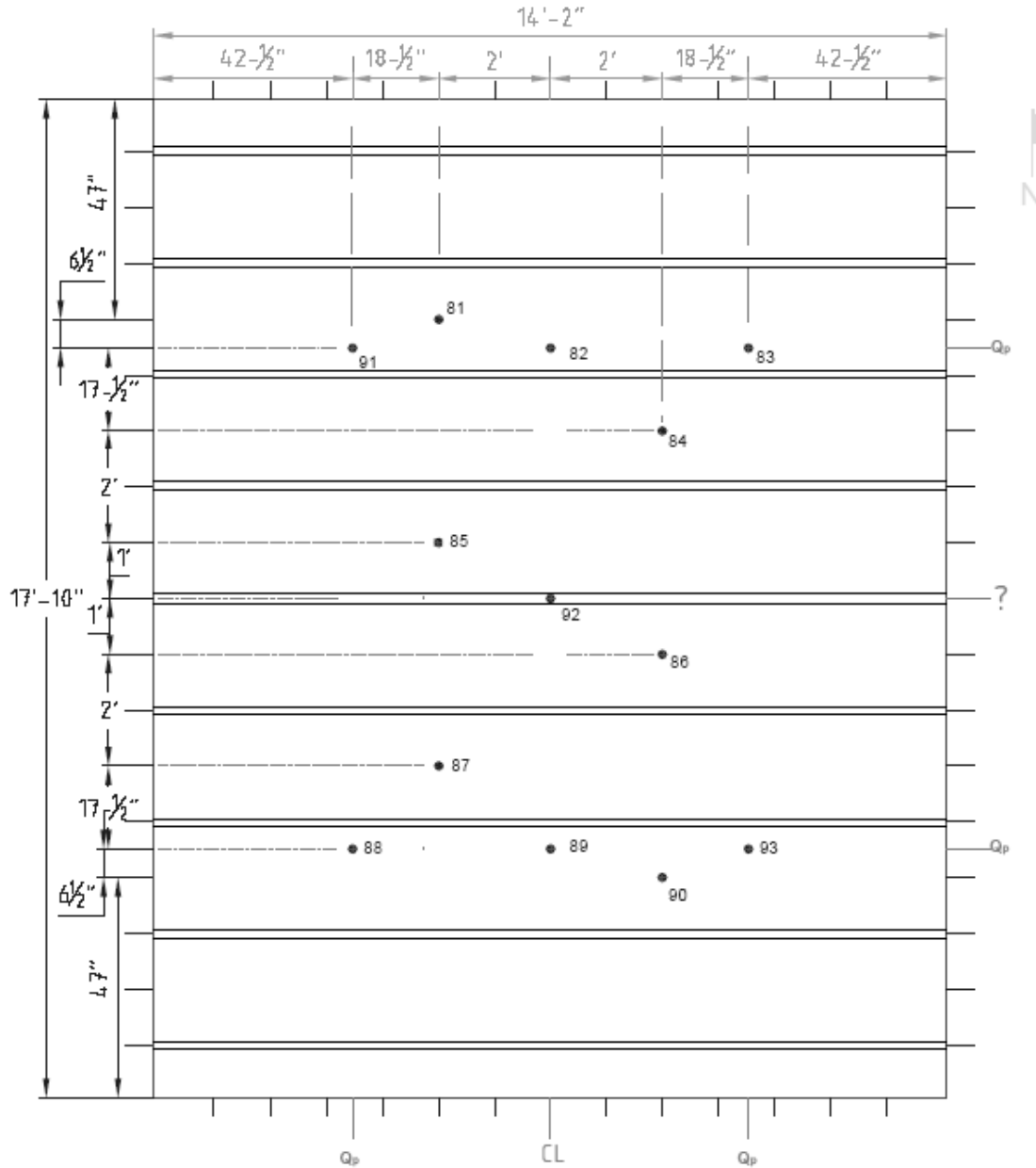

Figure A.4.6 – Thermocouple Locations on Unexposed Surface.

Assembly No. 4

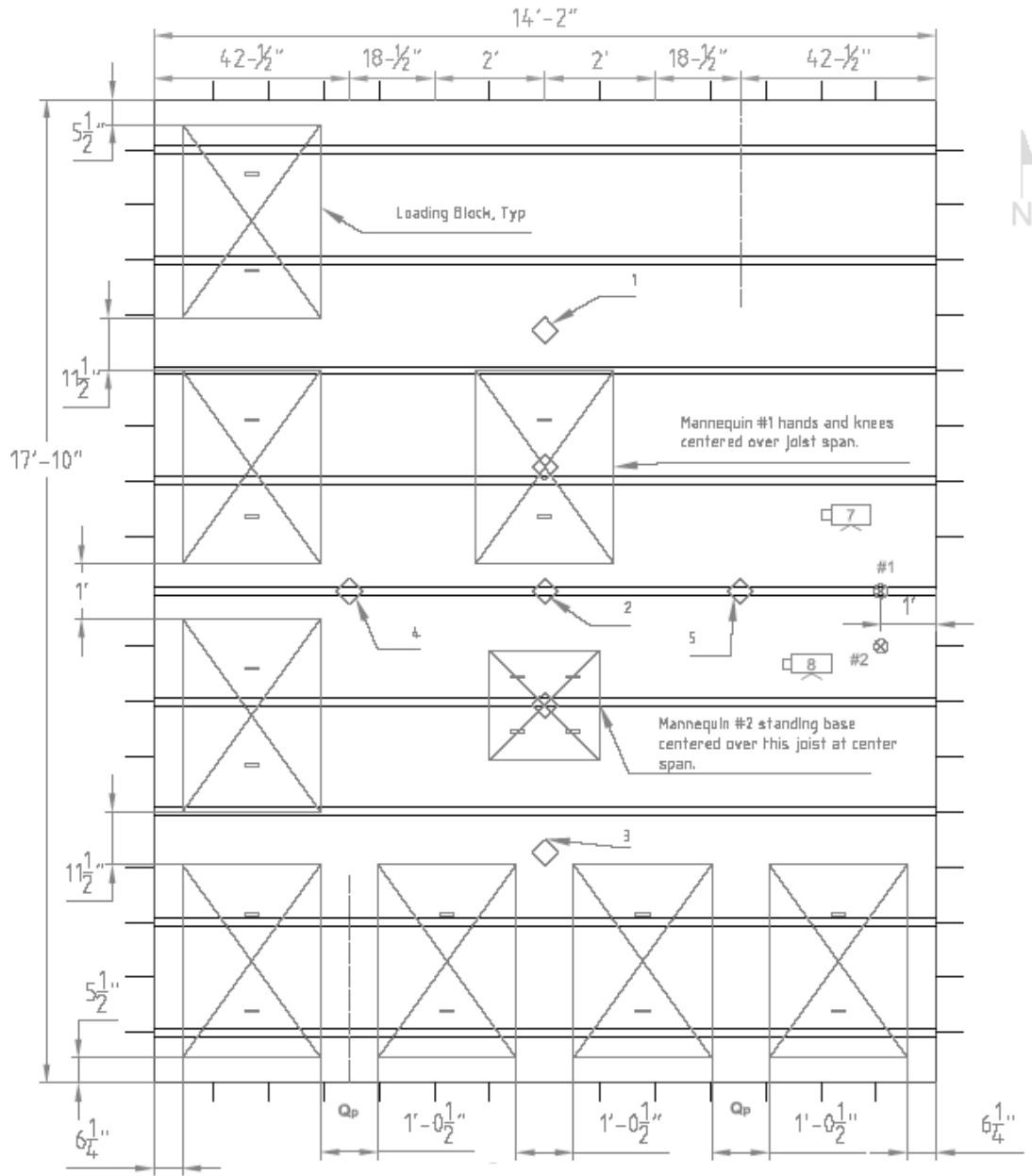

Figure A.4.7 – Loading and Instrumentation Layout (See Figure A.4.8).

Assembly No. 4**Deflection Transducers:**

- 1 - Along E-W Centerline, North Quarter-point.
- 2 - Along E-W Centerline, Center-point.
- 3 - Along E-W Centerline, South Quarter-point.
- 4 - Along N-S Centerline, East Quarter-point.
- 5 - Along N-S Centerline, West Quarter-point.

Accelerometers:

- 1- Over Joist, 12 in. from East edge of assembly.
- 2- Over Center of Span, 12 in. from East edge of assembly.

Audio Recordings: (Not Shown)

- 1 - Mannequin No. 1 (Hands & Knees)
- 2 - Mannequin No. 2 (Standing)

Video Camera Recordings: (Not Shown)

Channel 1409 - floor level view from northeast corner
Channel 1411 - IR camera from curing cell roof east center
Channel 1412 - furnace camera from northwest corner
Channel 1416 - overhead from east center of assembly

Channel 1413 - overhead from south center of assembly
Channel 1503 - overhead from west center of assembly

Video Camera Recordings:

Channel 1415 - internal camera east (installed in joist cavity 6 from north facing west - under kneeling mannequin #1.
Channel 1502 - internal camera east (installed in joist cavity 8 from north facing west -under standing mannequin #2.

Furnace Pressure Probes: (Not Shown)

- 1 - located near plate thermocouple No. 78
- 2 - located near plate thermocouple No. 79

Oxygen Content : (Not Shown)

located in E exhaust duct.

Figure A.4.8 – Loading and Instrumentation Key

Assembly No. 5

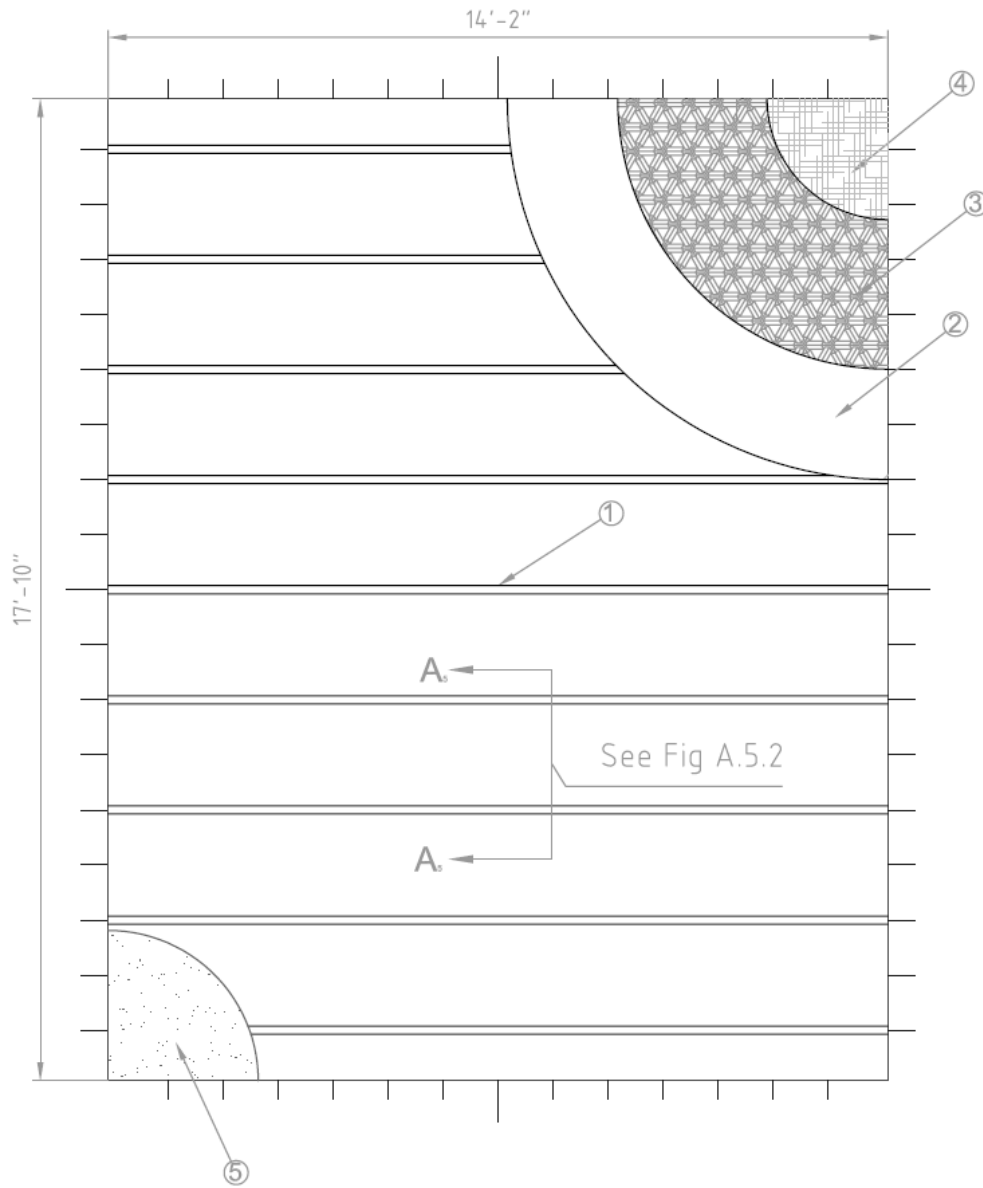

Figure A.5.1 – Construction Layout

Assembly No. 5

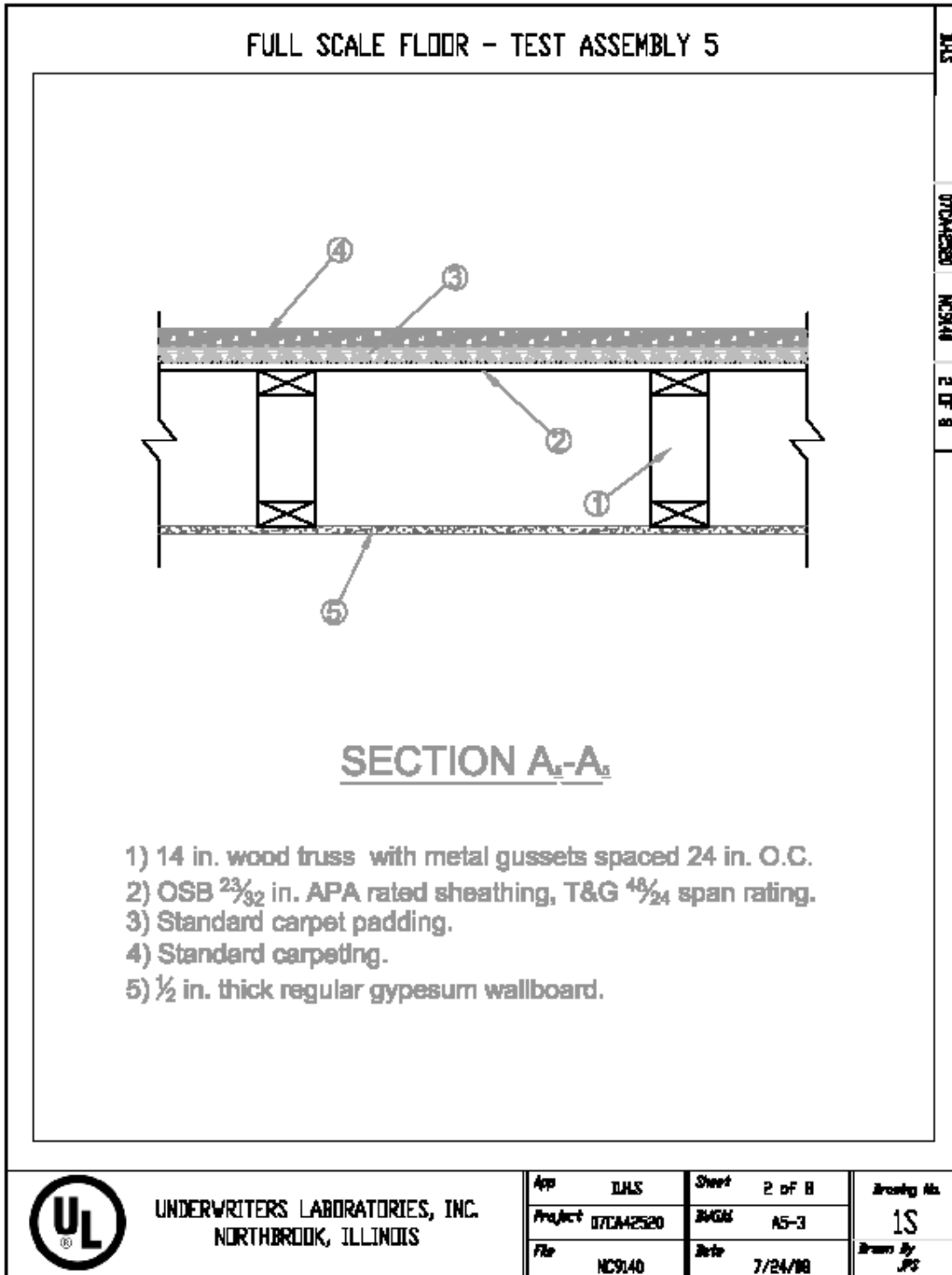

Figure A.5.2 – Construction Layout Section A₅-A₅.

Assembly No. 5

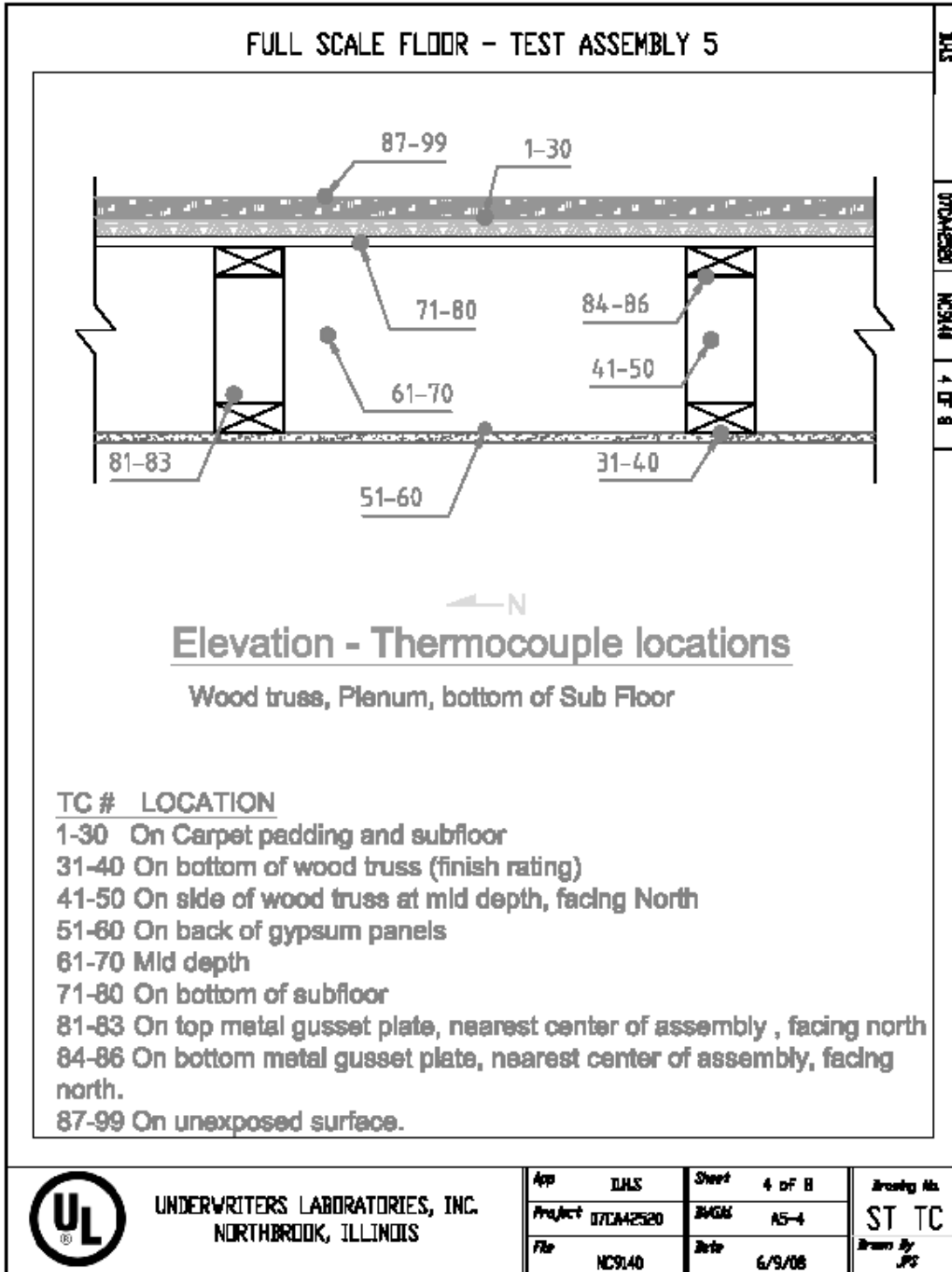

Figure A.5.3 – Thermocouple Locations - Elevation.

Assembly No. 5

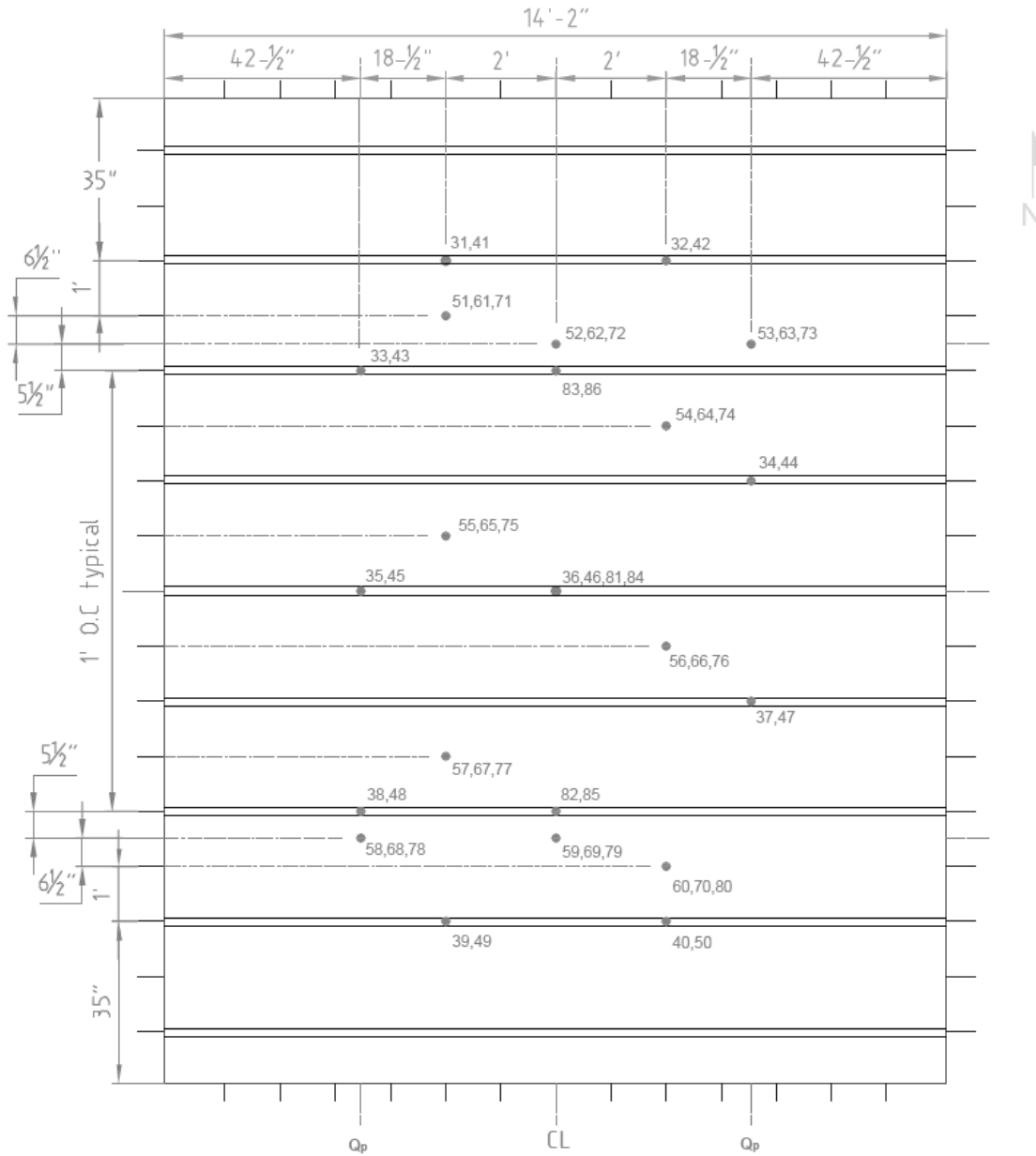

Figure A.5.4 – Thermocouple Locations on Wood Members.

Assembly No. 5

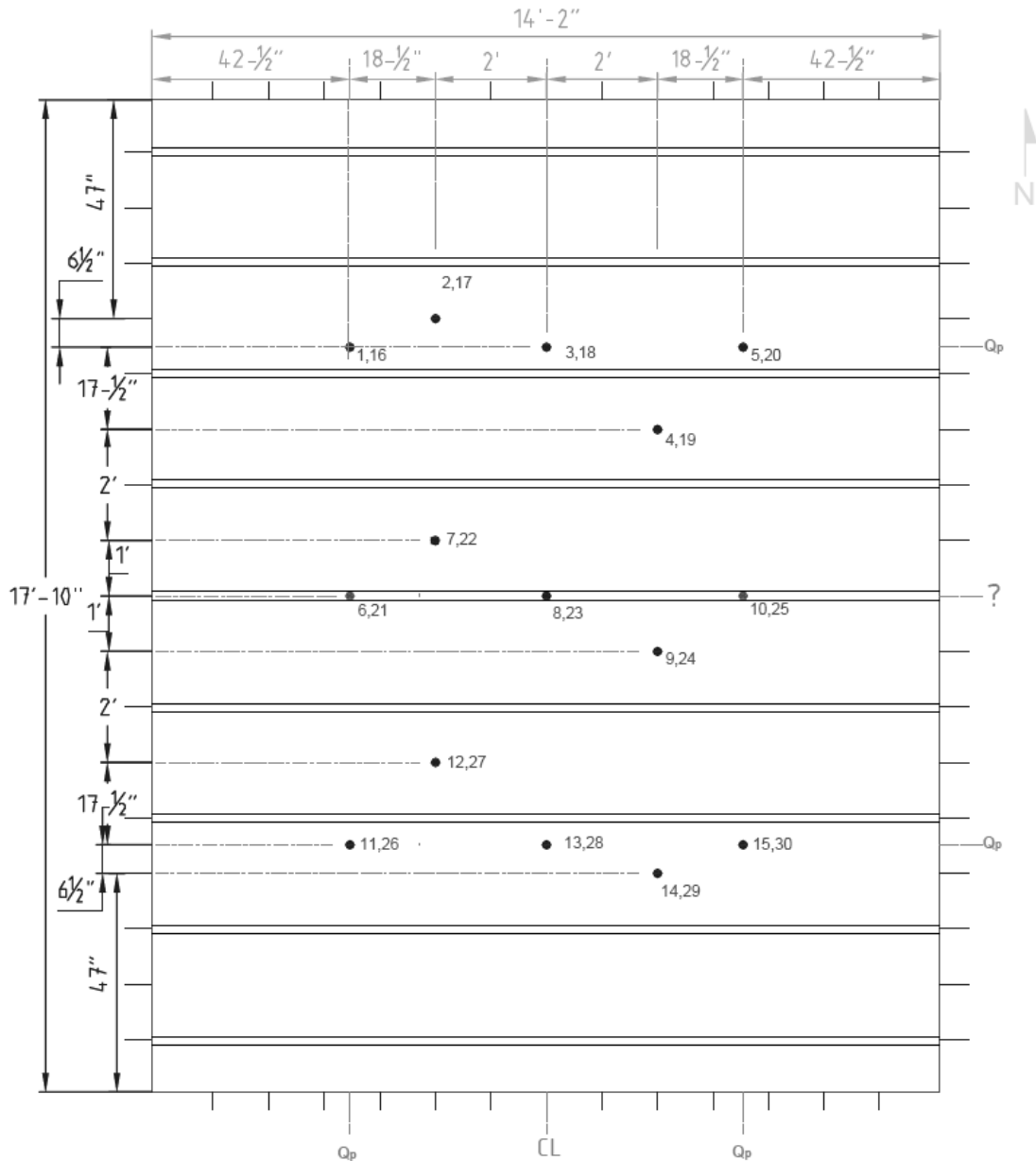

Figure A.5.5 – Thermocouple Locations on Subfloor and Carpet Padding.

Assembly No. 5

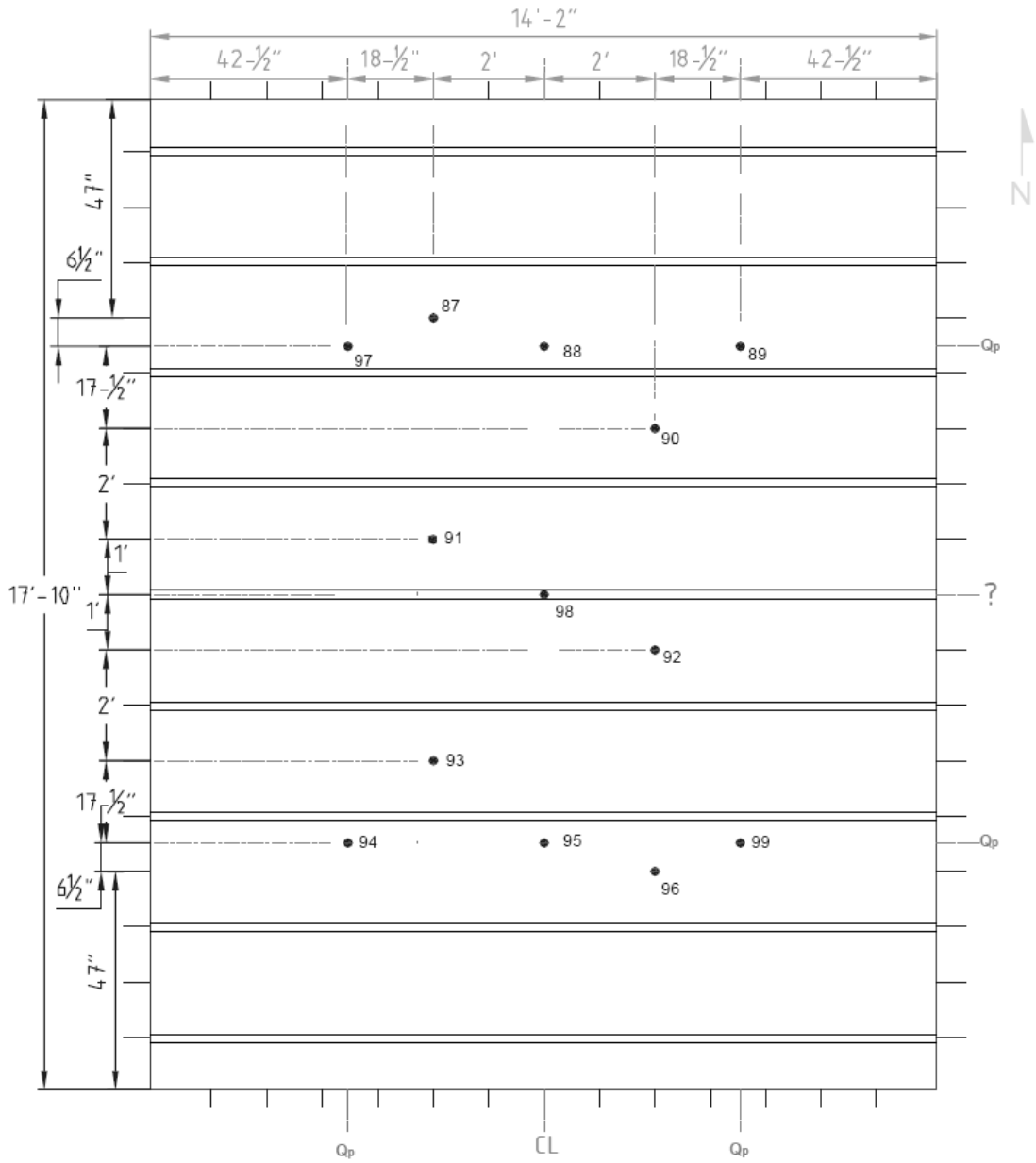

Figure A.5.6 – Thermocouple Locations on Unexposed Surface.

Assembly No. 5

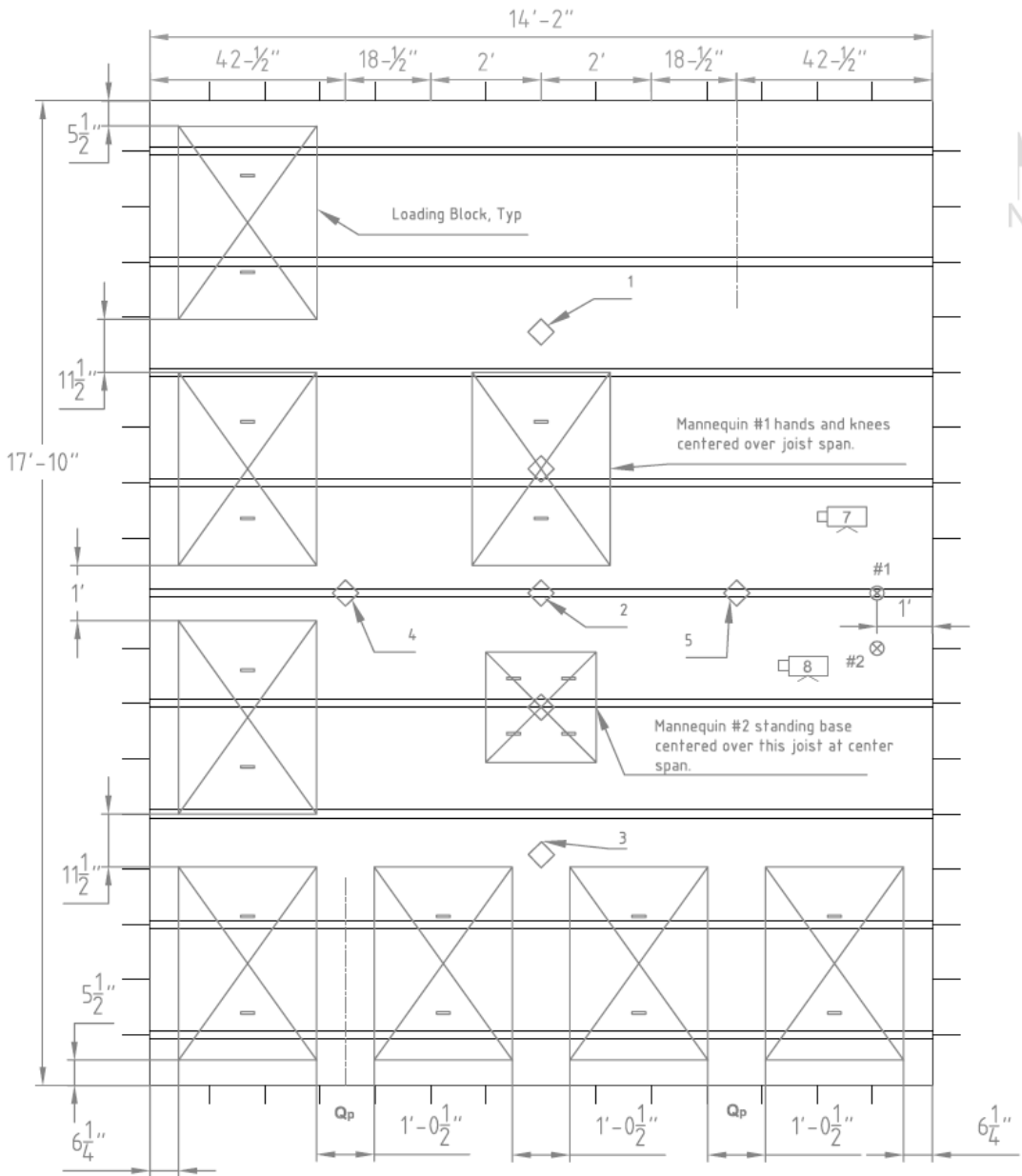

Figure A.5.7 – Loading and Instrumentation Layout (See Figure A.5.8).

Assembly No. 5**Deflection Transducers:**

- 1 - Along E-W Centerline, North Quarter-point.
- 2 - Along E-W Centerline, Center-point.
- 3 - Along E-W Centerline, South Quarter-point.
- 4 - Along N-S Centerline, East Quarter-point.
- 5 - Along N-S Centerline, West Quarter-point.

Accelerometers:

- 1- Over Joist, 12 in. from East edge of assembly.
- 2- Over Center of Span, 12 in. from East edge of assembly.

Audio Recordings: (Not Shown)

- 1 - Mannequin No. 1 (Hands & Knees)
- 2 - Mannequin No. 2 (Standing)

Video Camera Recordings: (Not Shown)

- #1 - Furnace Camera (Facing South East)
- #2 - Floor Level Unexposed Surface View (Facing South)
- #3 - Aerial Unexposed Surface View (Facing East, Center Camera)
- #4 - Aerial Unexposed Surface View (Facing North, Center Camera)
- #5 - Aerial Unexposed Surface View (Facing West, Center Camera)
- #6 - Thermal Imaging Aerial Unexposed Surface View (Centered and Facing West)

**Video Camera Recordings:**

- #7 Concealed space, facing East, towards mannequin #1
- #8 Concealed space, facing East, towards mannequin #2

Figure A.5.8 – Loading and Instrumentation Key

Assembly No. 6

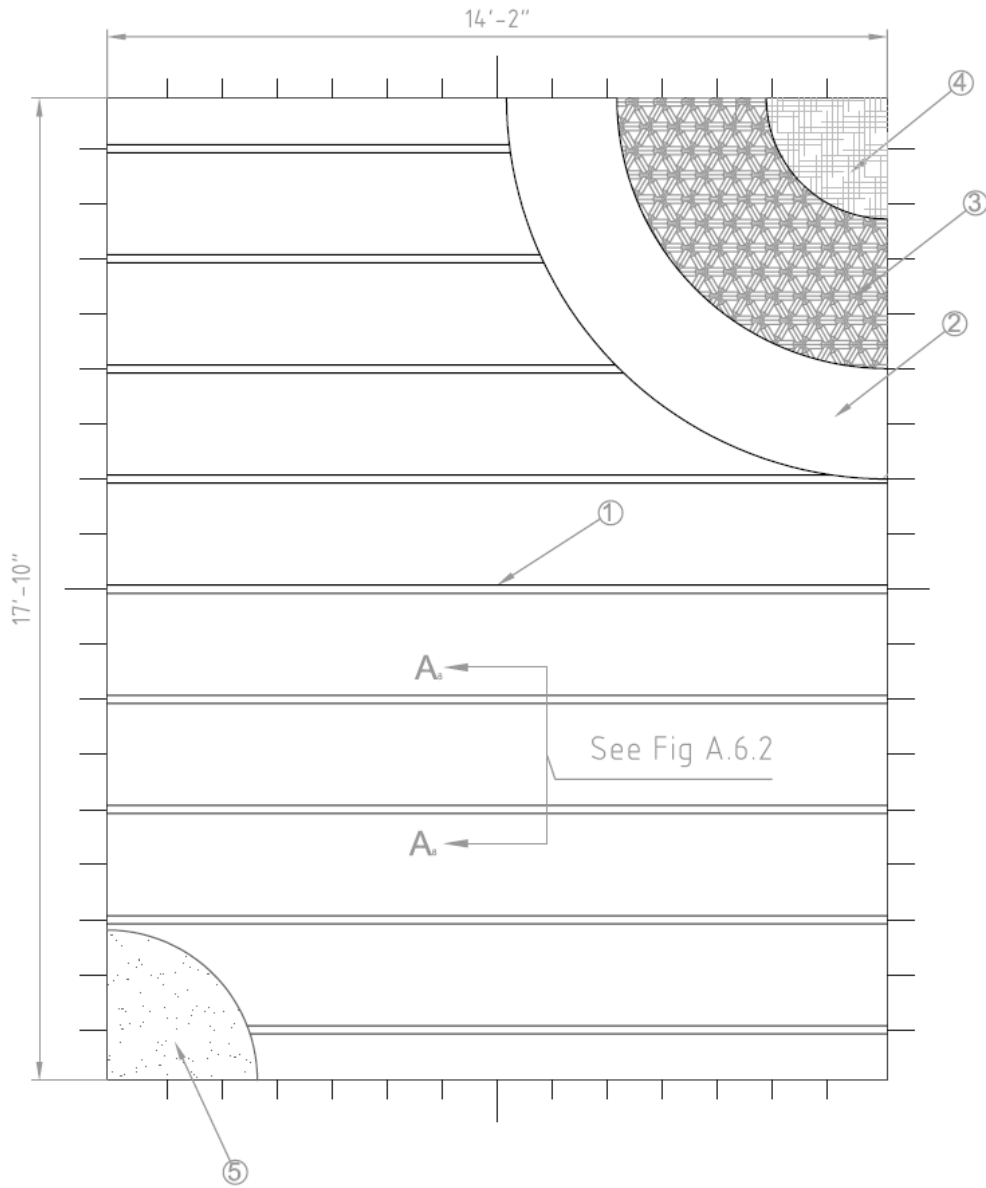
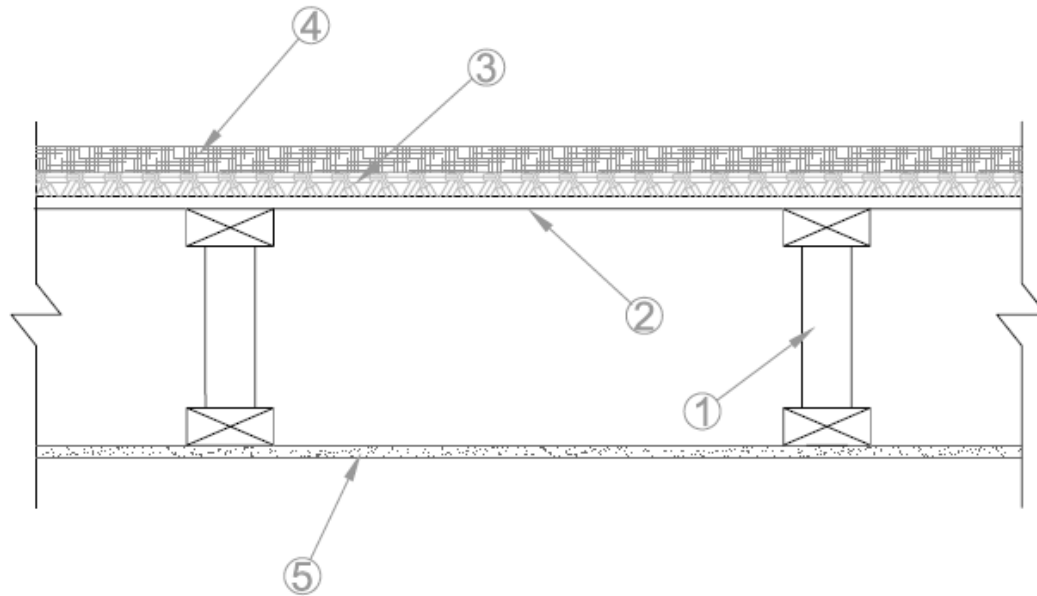

Figure A.6.1 – Construction Layout

Assembly No. 6

SECTION A₆-A₆

- 1) 14 in. Deep wood truss with glued finger joints spaced 24 in. O.C.
- 2) OSB $\frac{23}{32}$ in. APA rated sheathing, T&G $\frac{48}{24}$ span rating.
- 3) Standard carpet padding.
- 4) Standard carpeting.
- 5) $\frac{1}{2}$ in. thick regular gypsum wallboard.

Figure A.6.2 – Construction Layout Section A₆-A₆.

Assembly No. 6

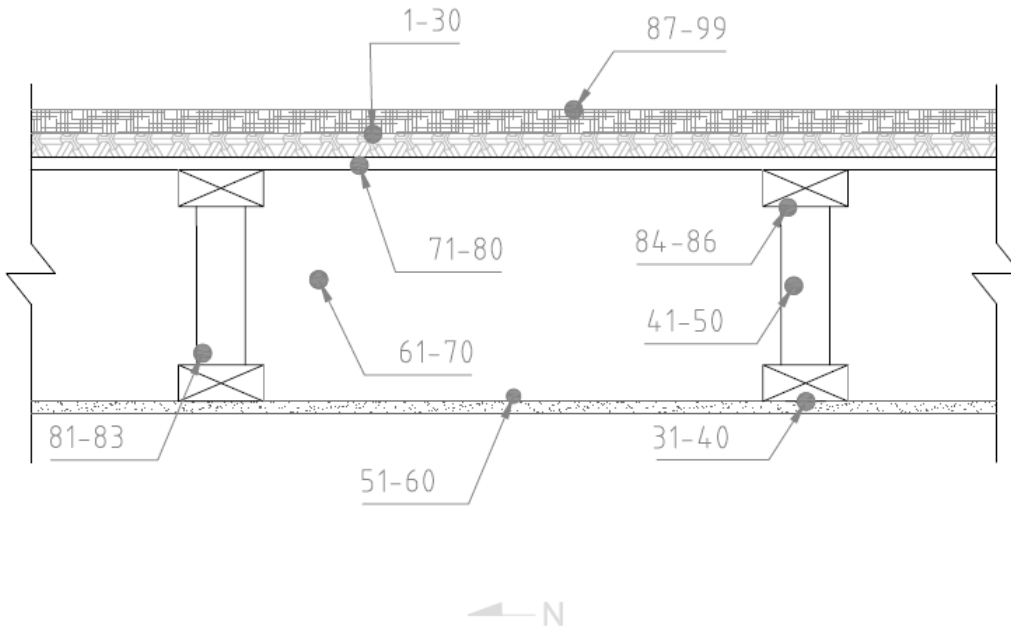

Elevation - Thermocouple Locations

Wood truss, Plenum, bottom of Sub Floor

TC # LOCATION

- 1-30 On subfloor and carpet padding
- 31-40 On bottom of wood truss (finish rating)
- 41-50 On side of wood truss at mid depth, facing North
- 51-60 On back of gypsum panels
- 61-70 Mid depth
- 71-80 On bottom of subfloor
- 81-83 On glued finger joint, nearest center of assembly , facing north
- 84-86 On glued finger joint, nearest center of assembly, facing north
- 87-99 On unexposed surface

Figure A.6.3 – Thermocouple Locations - Elevation.

Assembly No. 6

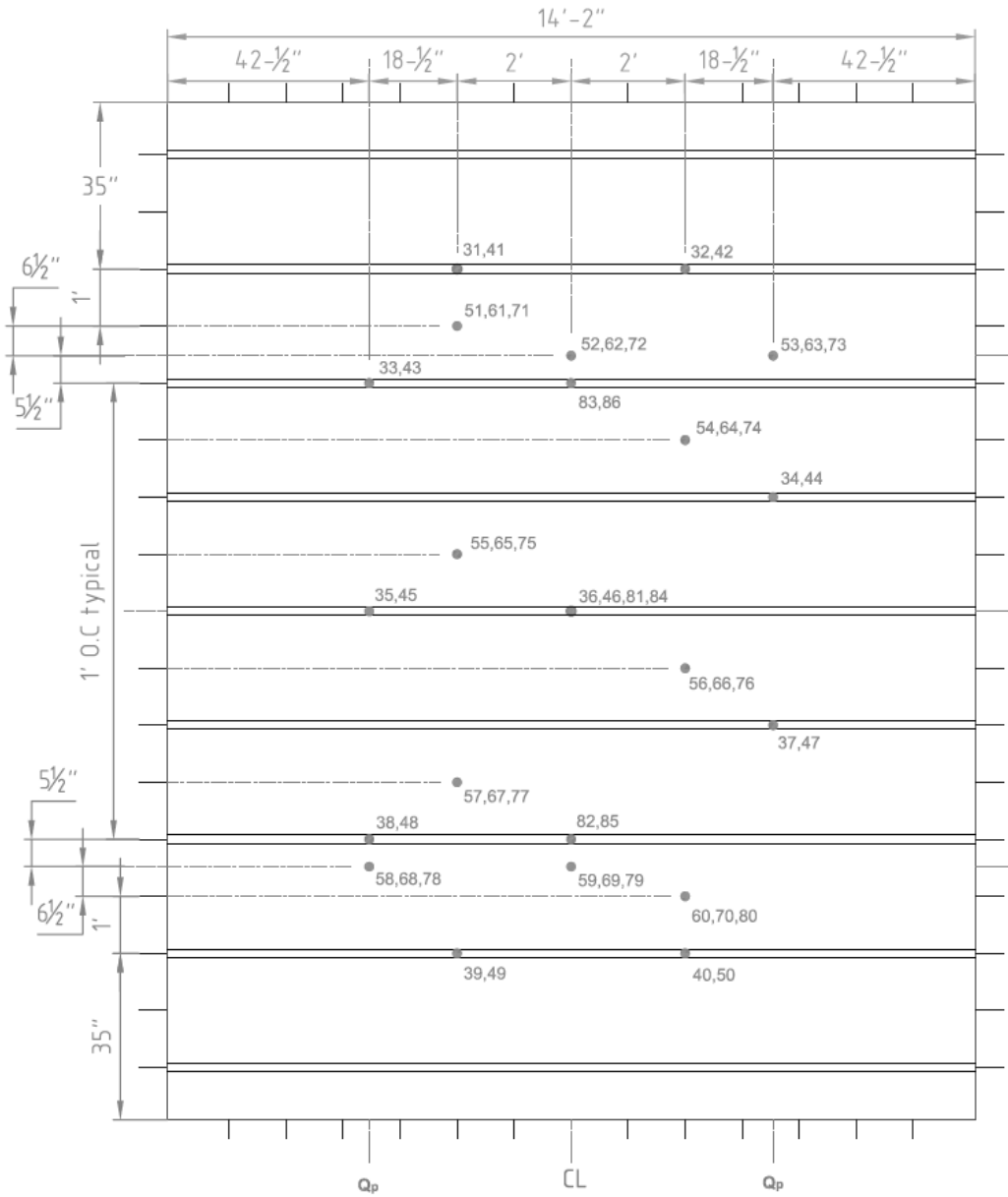

Figure A.6.4 – Thermocouple Locations on Wood Members.

Assembly No. 6

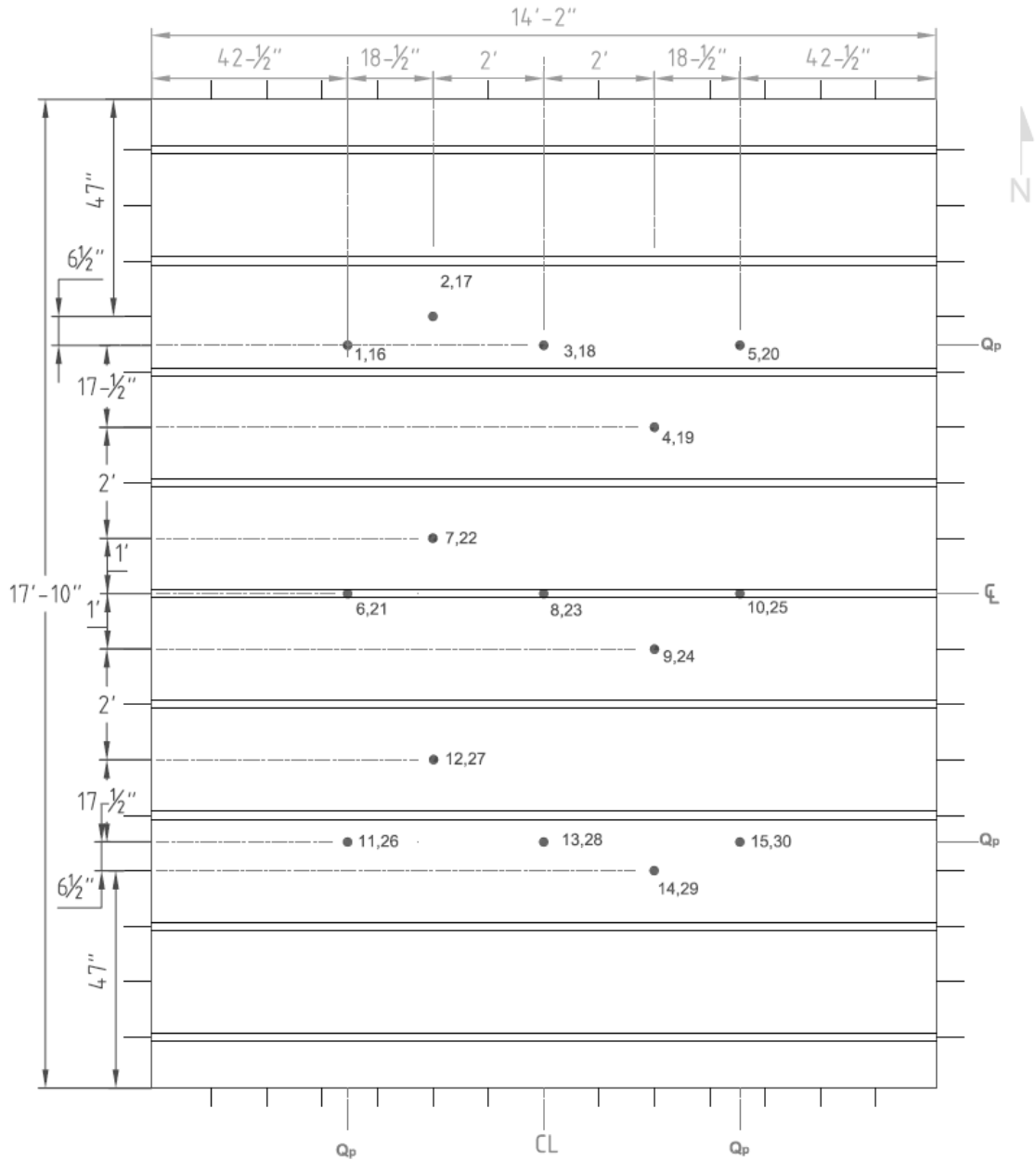

Figure A.6.5 – Thermocouple Locations on Subfloor and Carpet Padding.

Assembly No. 6

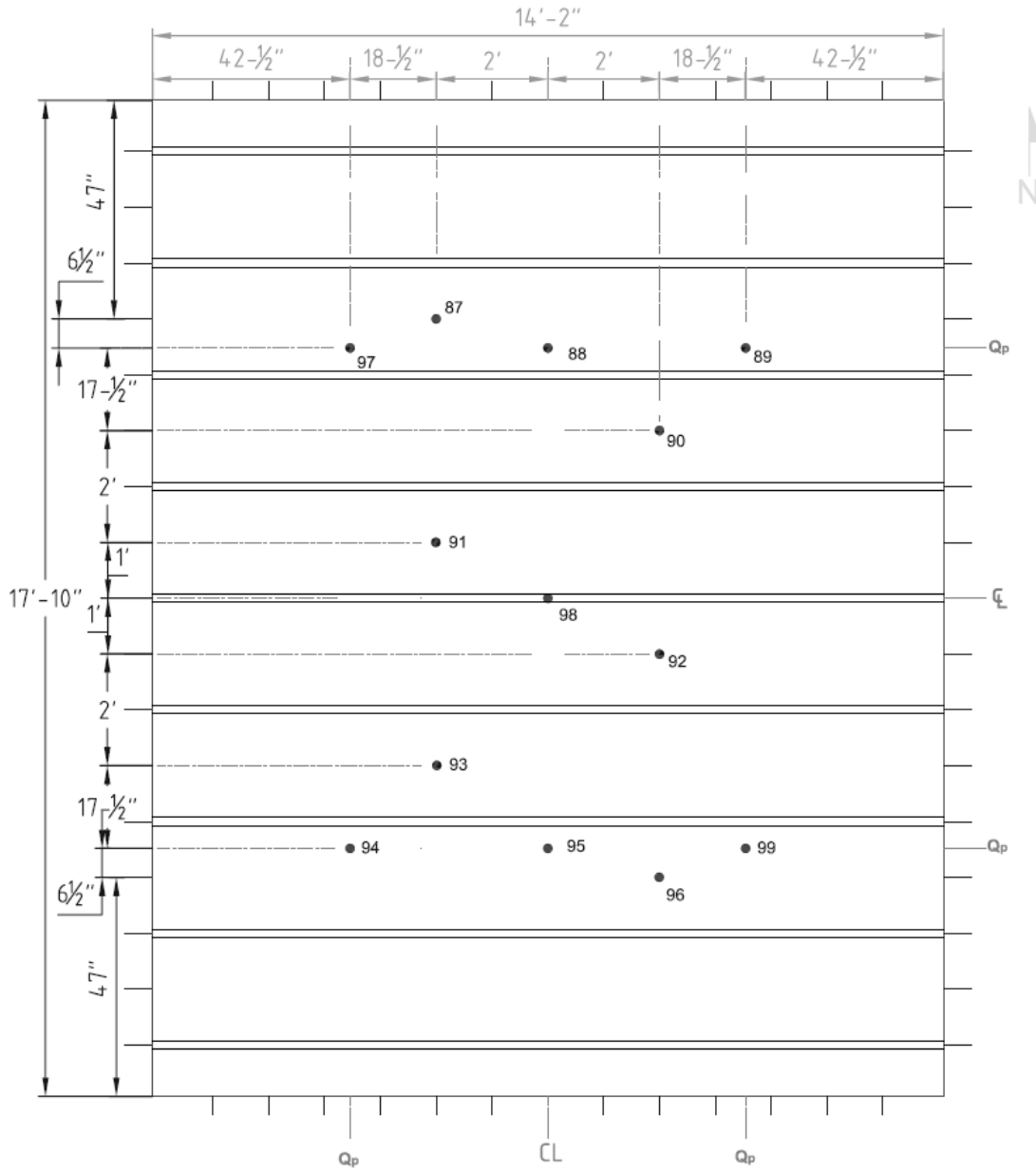

Figure A.6.6 – Thermocouple Locations on Unexposed Surface.

Assembly No. 6

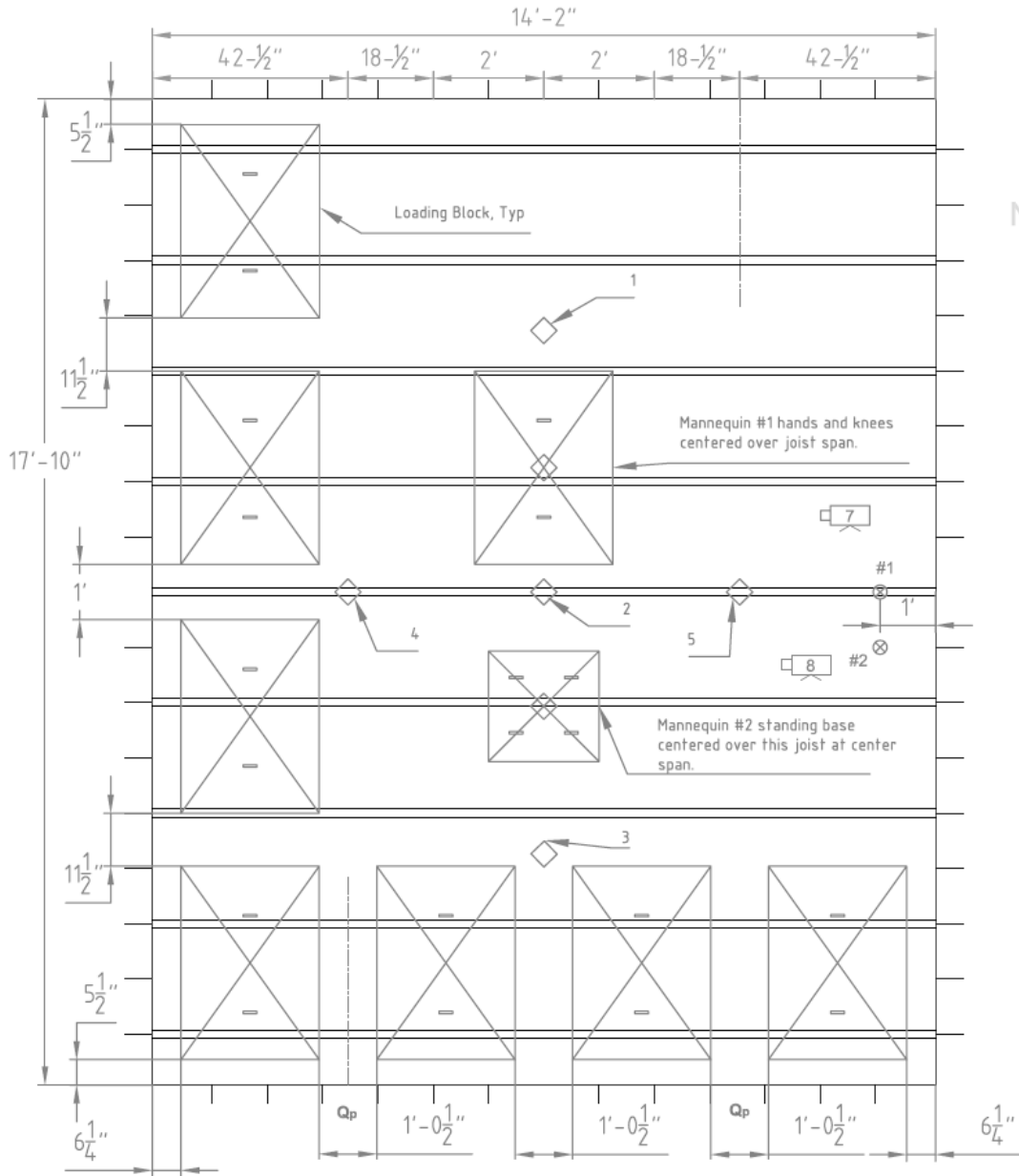

Figure A.6.7 – Loading and Instrumentation Layout (See Figure A.6.8)

Assembly No. 6

Deflection Transducers: 

- 1 - Along E-W Centerline, North Quarter-point.
- 2 - Along E-W Centerline, Center-point.
- 3 - Along E-W Centerline, South Quarter-point.
- 4 - Along N-S Centerline, East Quarter-point.
- 5 - Along N-S Centerline, West Quarter-point.

Accelerometers: 

- 1- Over Joist, 12 in. from East edge of assembly.
- 2- Over Center of Span, 12 in. from East edge of assembly.

Audio Recordings: (Not Shown)

- 1 - Mannequin No. 1 (Hands & Knees)
- 2 - Mannequin No. 2 (Standing)

Video Camera Recordings: (Not Shown)

- Channel 1409 - floor level view from northeast corner
- Channel 1411 - IR camera from curing cell roof east center
- Channel 1412 - furnace camera from northwest corner
- Channel 1416 - overhead from east center of assembly
- Channel 1413 - overhead from south center of assembly
- Channel 1503 - overhead from west center of assembly

Video Camera Recordings: 

- Channel 1415 - internal camera east (installed in joist cavity 6 from north facing west - under kneeling mannequin #1.
- Channel 1502 - internal camera east (installed in joist cavity 8 from north facing west -under standing mannequin #2.

Furnace Pressure Probes: (Not Shown)

- 1 - located near plate thermocouple No. 100
- 2 - located near plate thermocouple No. 101

Oxygen Content : (Not Shown)

located in E exhaust duct.

Figure A.6.8 – Loading and Instrumentation Key

Assembly No. 7

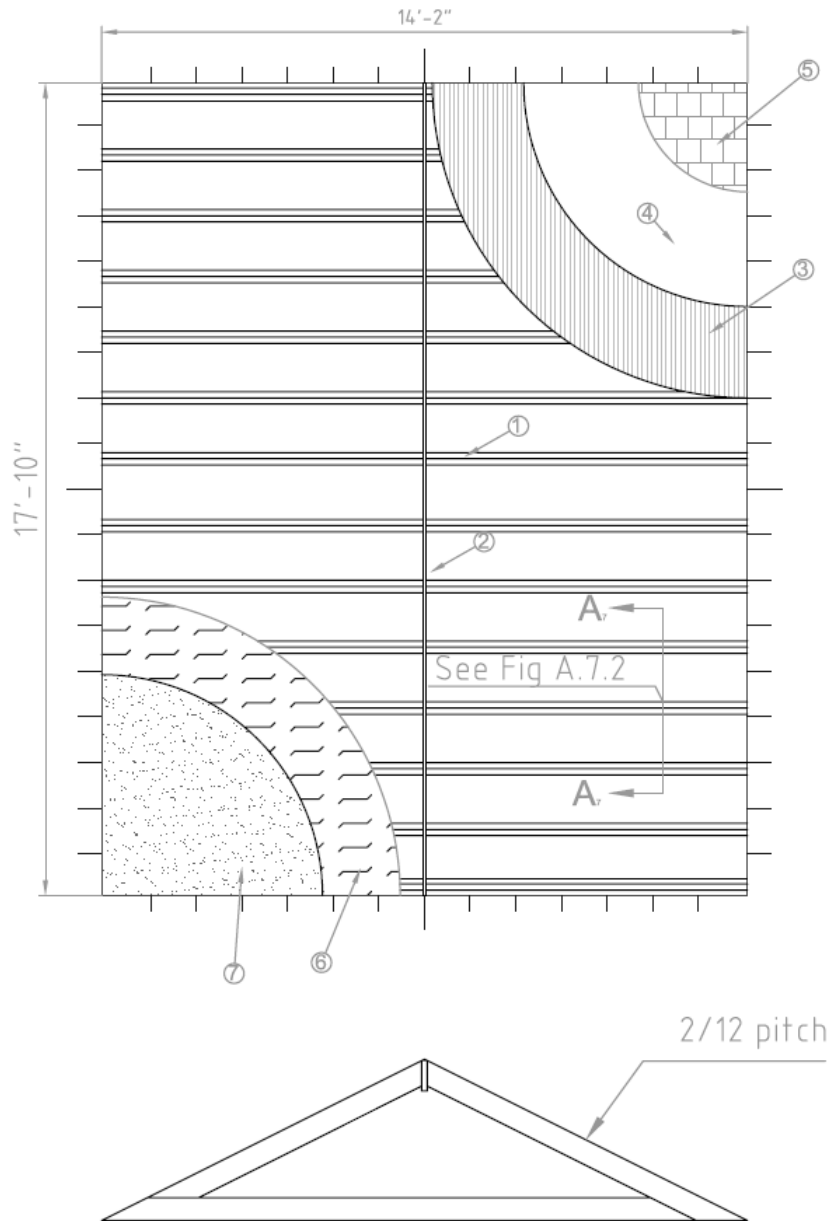

Figure A.7.1 – Construction Layout

Assembly No. 7

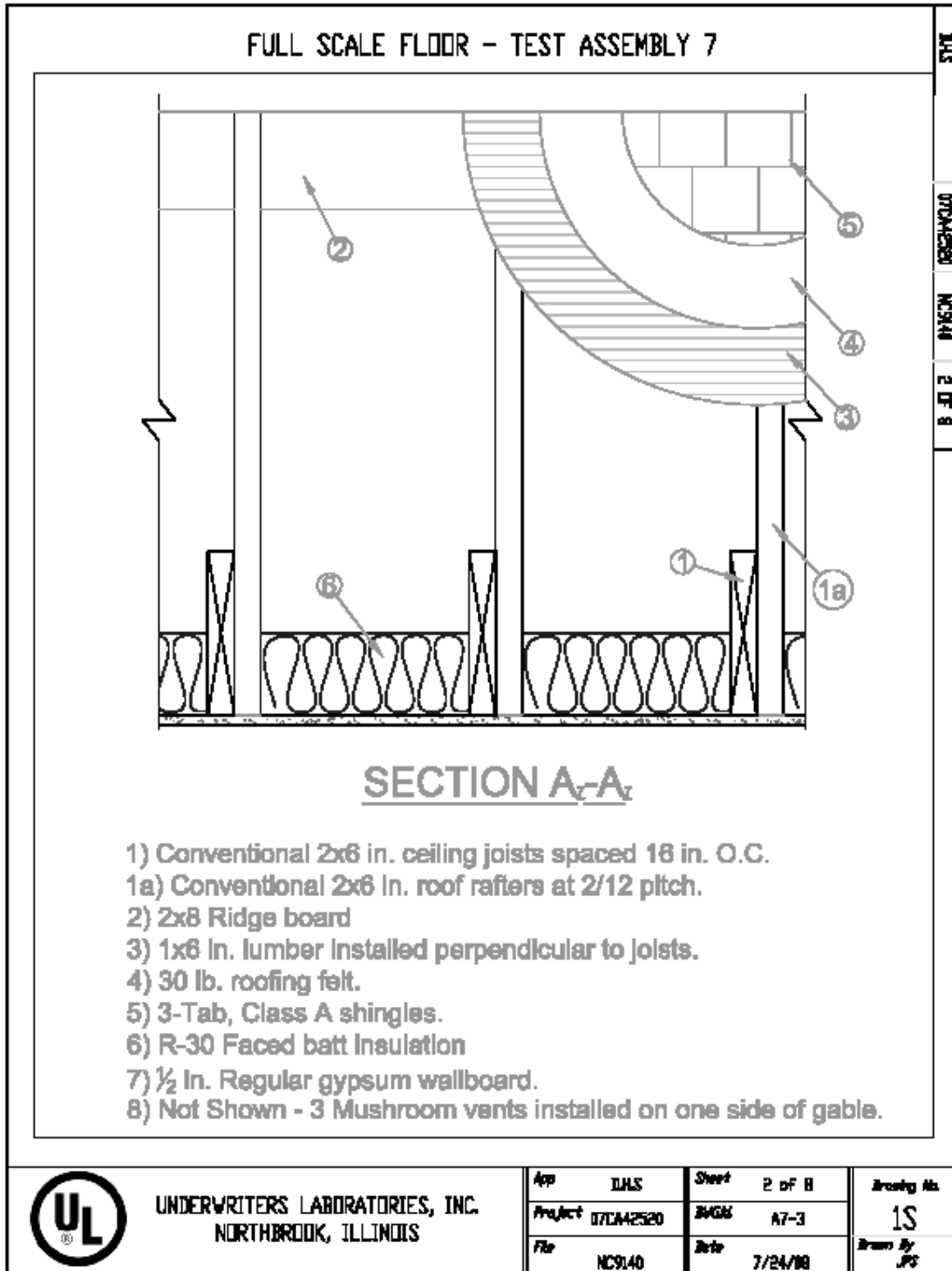

Figure A.7.2 – Construction Layout Section A₇-A₇.

Assembly No. 7

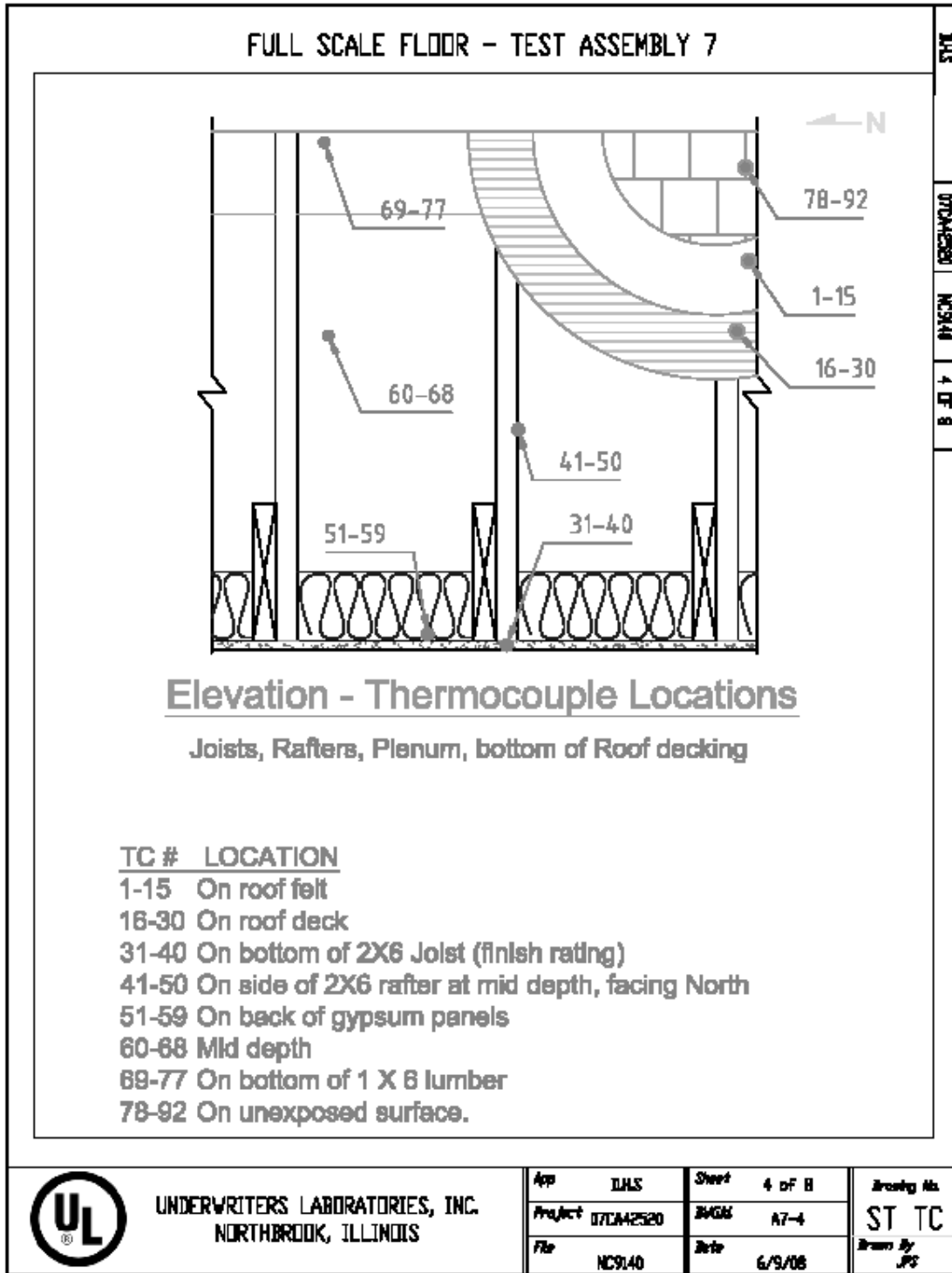

Figure A.7.3 – Thermocouple Locations - Elevation.

Assembly No. 7

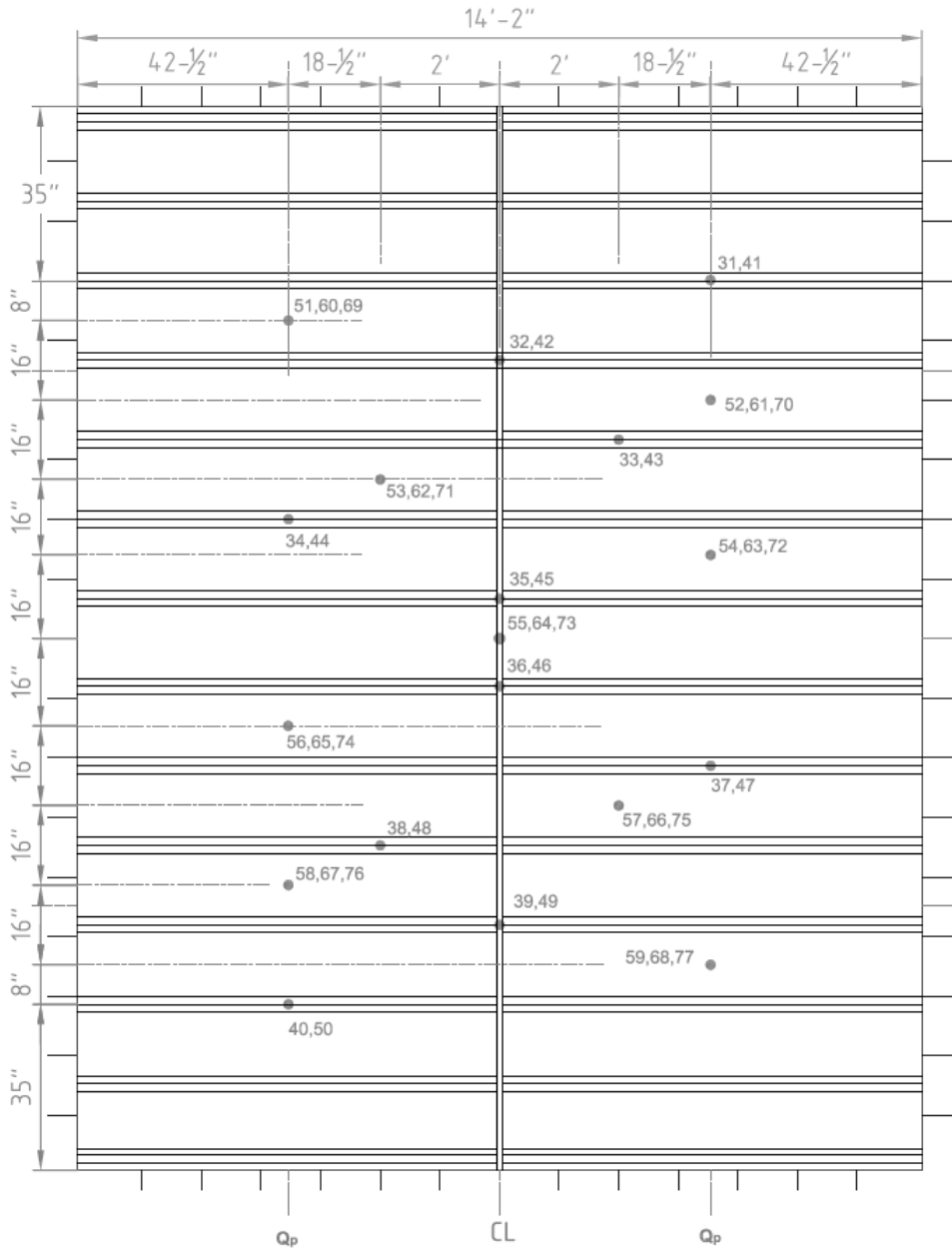

Figure A.7.4 – Thermocouple Locations on Wood Members.

Assembly No. 7

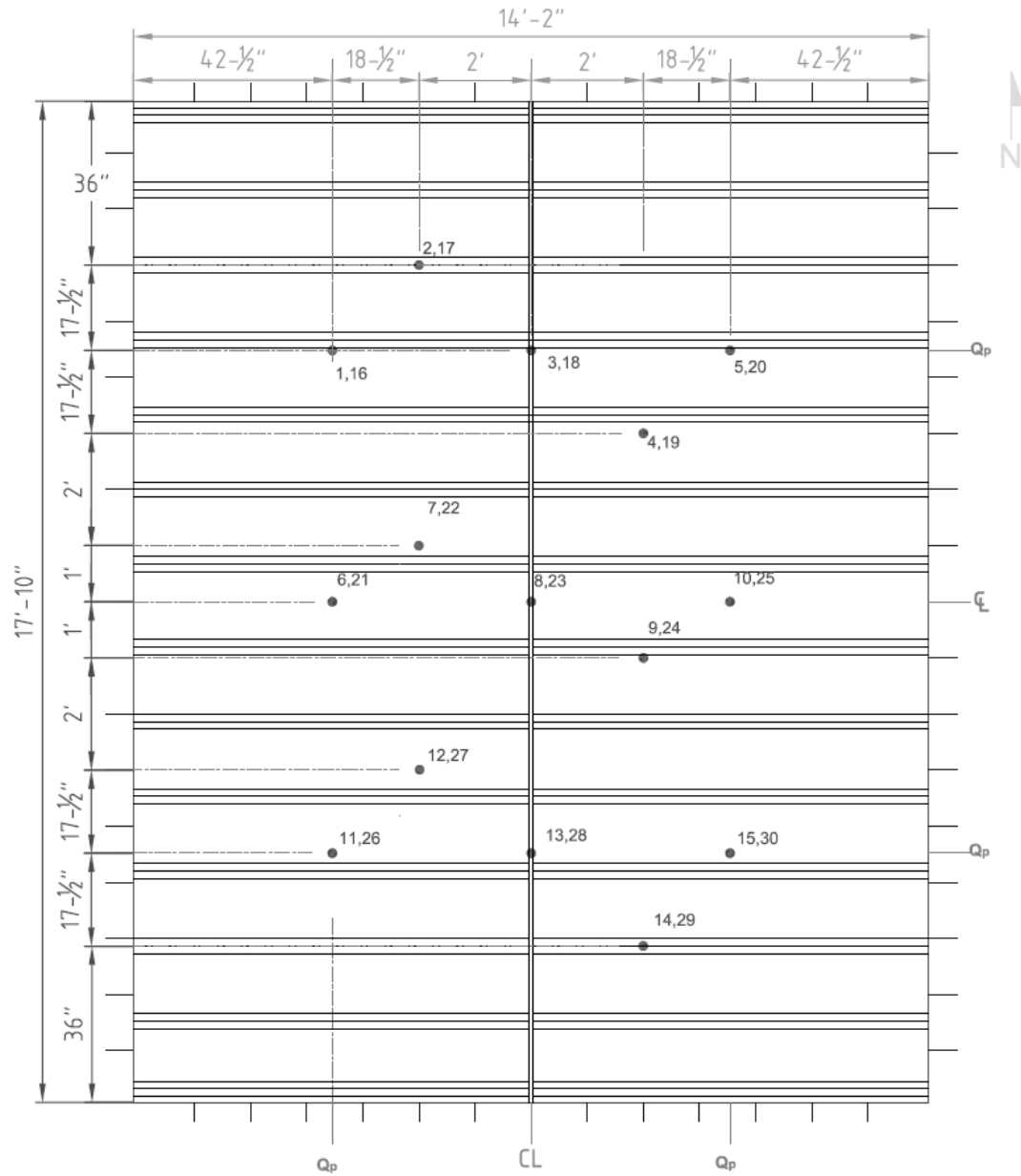
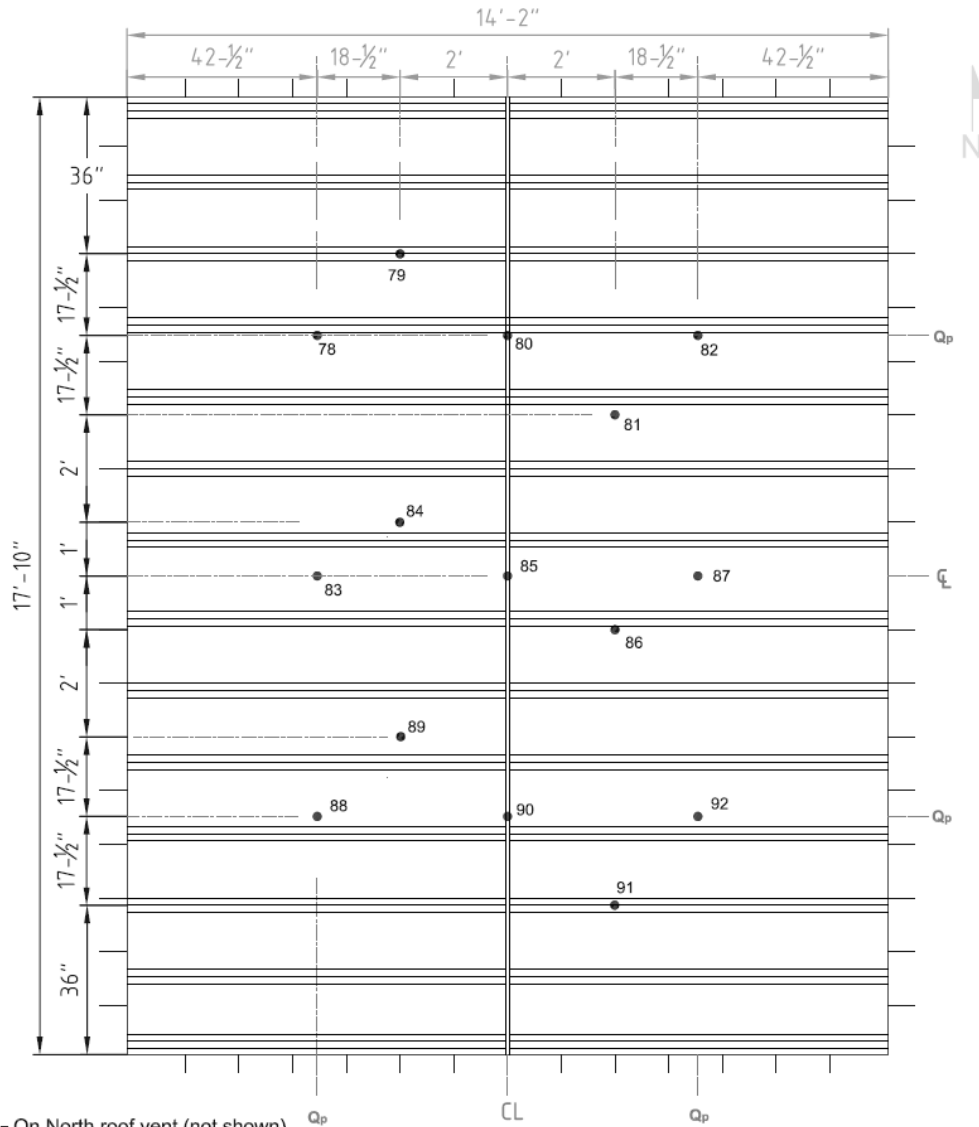

Figure A.7.5 – Thermocouple Locations on Roof Deck and Roof Felt.

Assembly No. 7



- 93 - On North roof vent (not shown)
- 94 - On Center roof vent (not shown)
- 95 - On South roof vent (not shown)

Figure A.7.6 – Thermocouple Locations on Unexposed Surface.

Assembly No. 7

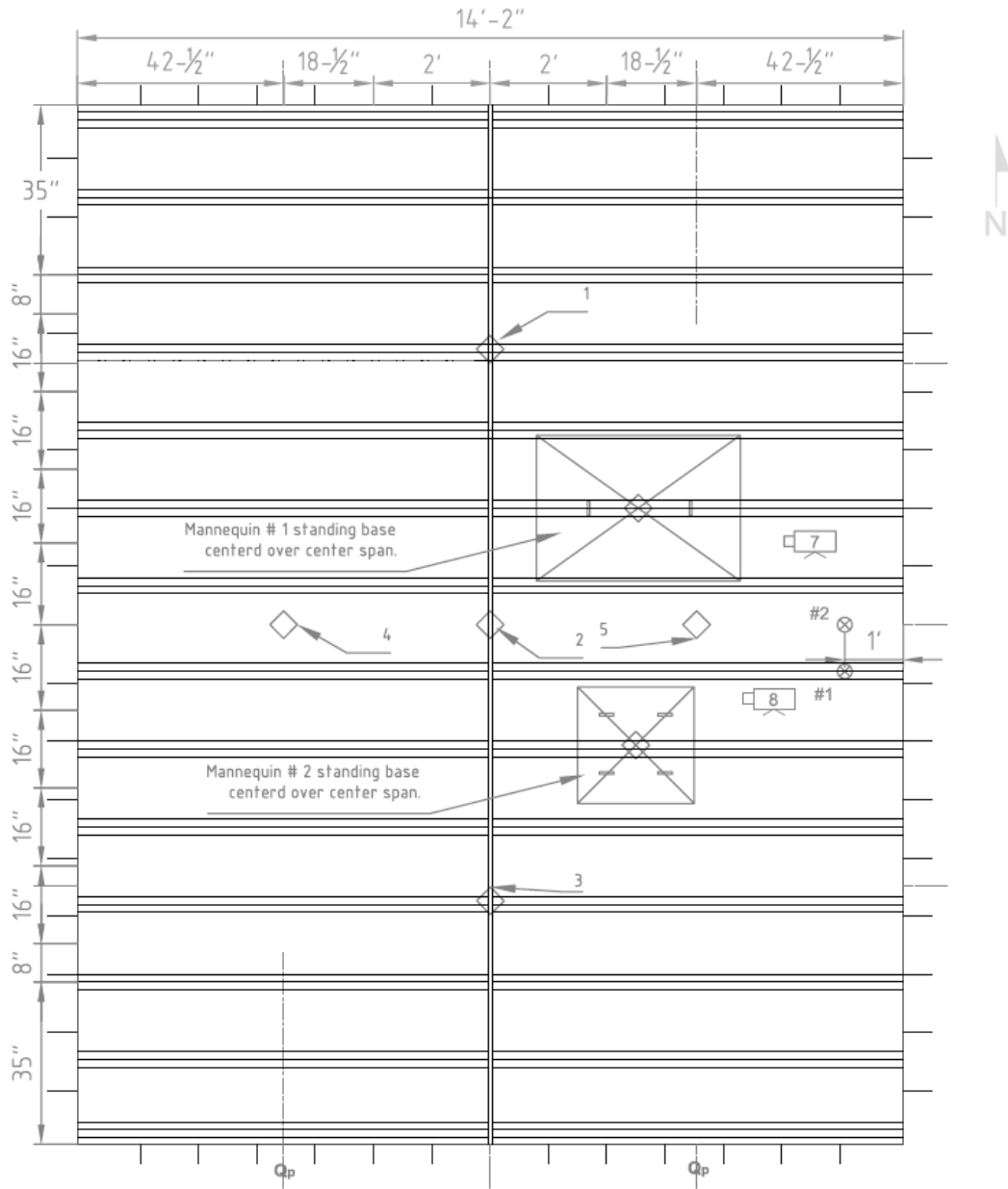

Figure A.7.7 – Loading and Instrumentation Layout (See Figure A.7.8).

Assembly No. 7**Deflection Transducers:** 

- 1 - Along E-W Centerline, North Quarter-point.
- 2 - Along E-W Centerline, Center-point.
- 3 - Along E-W Centerline, South Quarter-point.
- 4 - Along N-S Centerline, East Quarter-point.
- 5 - Along N-S Centerline, West Quarter-point.

Accelerometers: 

- 1- Over rafter, 12 in. from East edge of assembly.
- 2- Over Center of Span, 12 in. from East edge of assembly.

Audio Recordings: (Not Shown)

- 1 - Mannequin No. 1 (Hands & Knees)
- 2 - Mannequin No. 2 (Standing)

Video Camera Recordings: (Not Shown)

- Channel 1409 - floor level view from northeast corner
- Channel 1411 - IR camera from curing cell roof east center
- Channel 1412 - furnace camera from northwest corner
- Channel 1416 - overhead from east center of assembly
- Channel 1413 - overhead from south center of assembly
- Channel 1503 - overhead from west center of assembly

Video Camera Recordings: 

- Channel 1415 - internal camera east (installed in joist cavity 6 from north facing west - under kneeling mannequin #1.
- Channel 1502 - internal camera east (installed in joist cavity 8 from north facing west -under standing mannequin #2.

Furnace Pressure Probes: (Not Shown)

- 1 - located near plate thermocouple No. 96
- 2 - located near plate thermocouple No. 97

Oxygen Content : (Not Shown)

located in E exhaust duct.

Figure A.7.8 – Loading and Instrumentation Key

Assembly No. 8

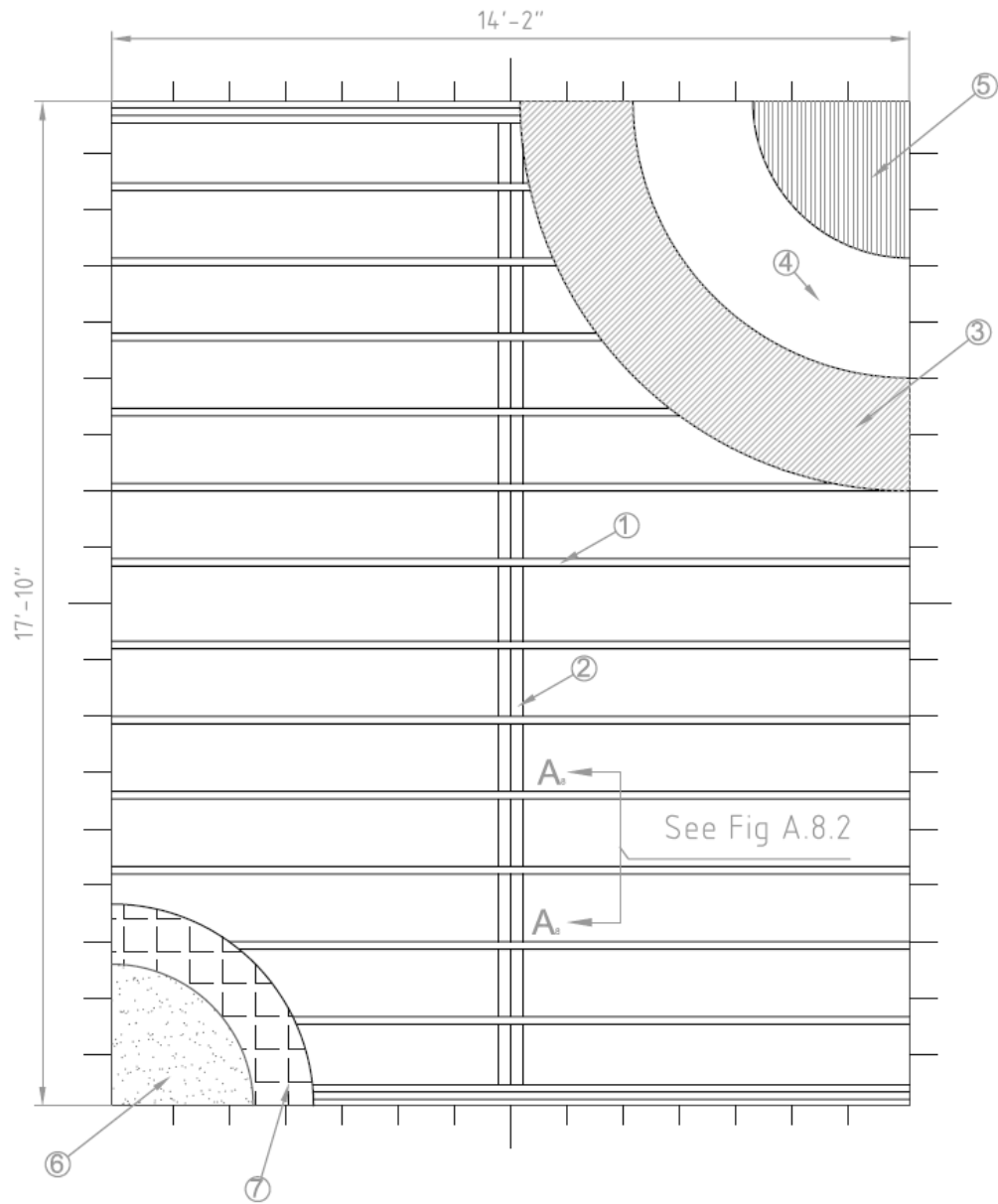

Figure A.8.1 – Construction Layout

Assembly No. 8

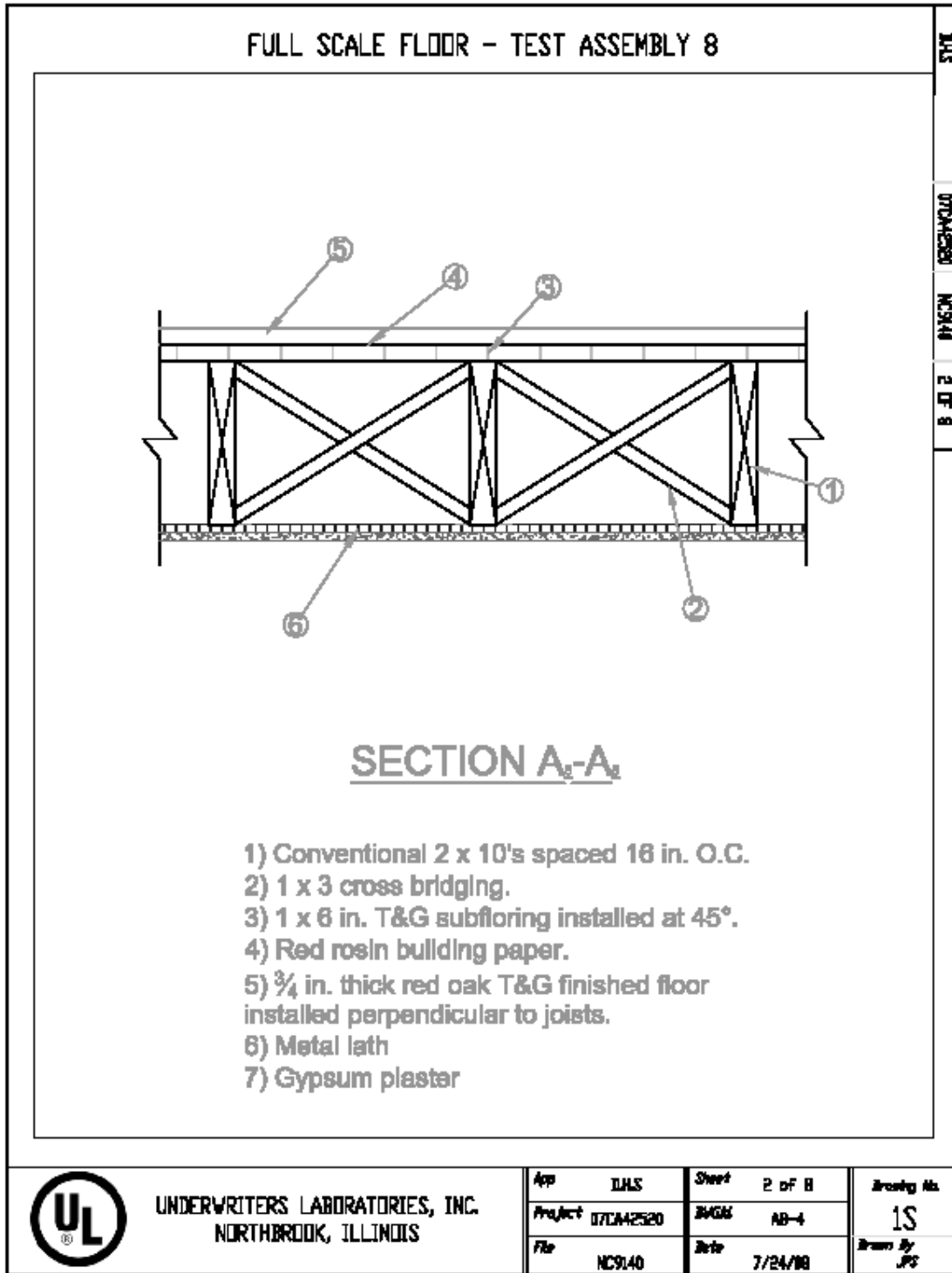

Figure A.8.2 – Construction Layout Section A₈-A₈.

Assembly No. 8

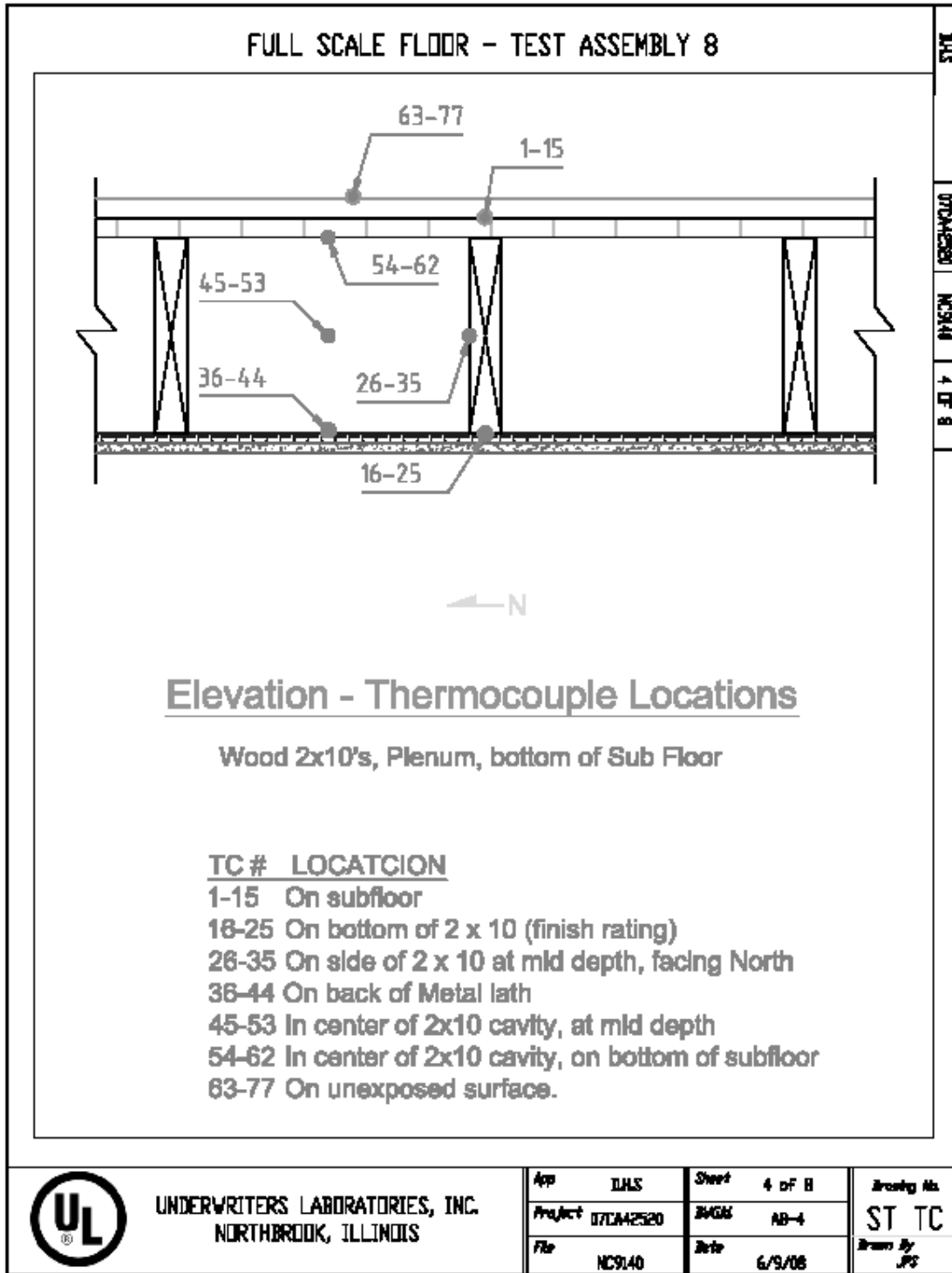

Figure A.8.3 – Thermocouple Locations - Elevation.

Assembly No. 8

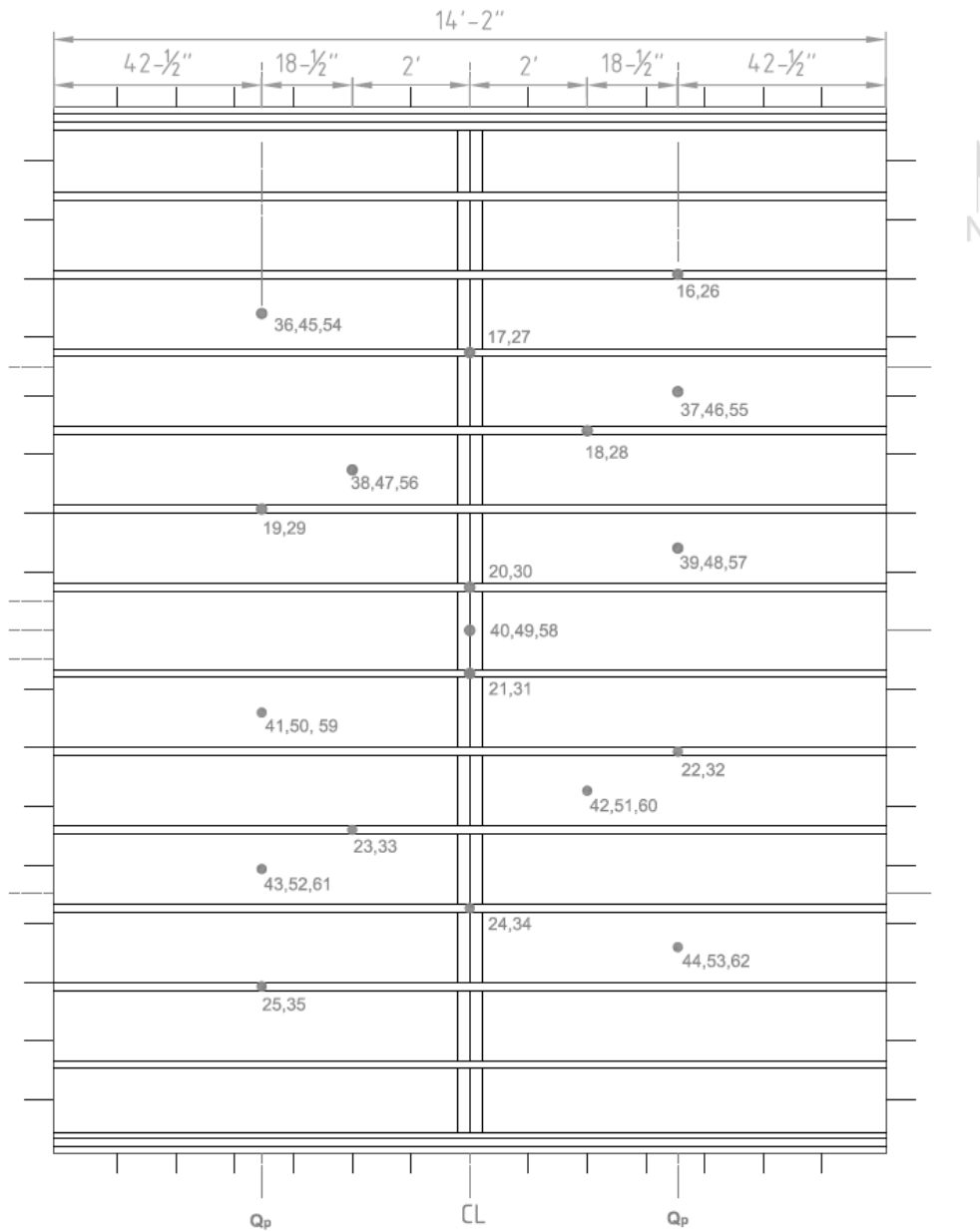

Figure A.8.4 – Thermocouple Locations on Wood Members.

Assembly No. 8

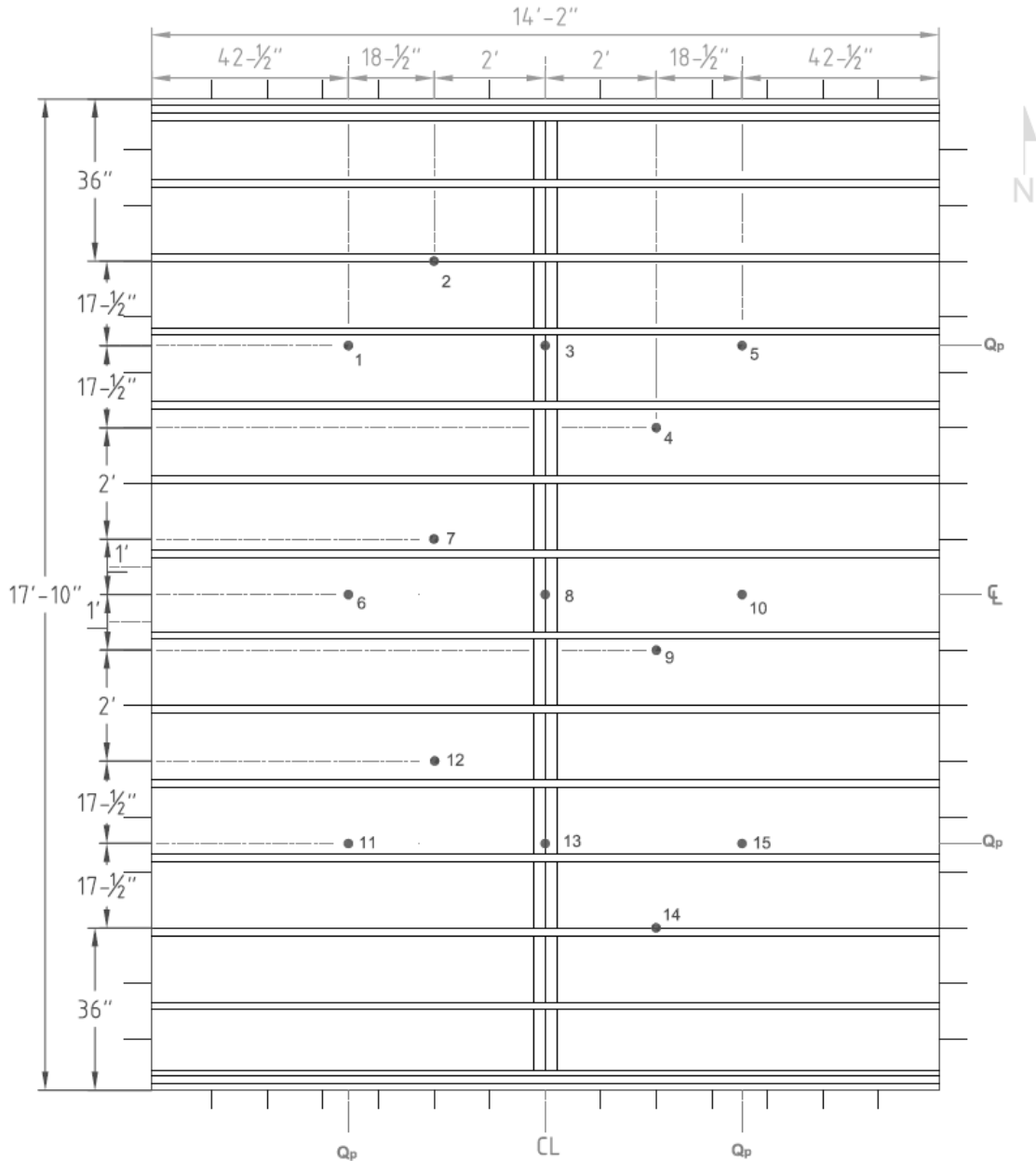

Figure A.8.5 – Thermocouple Locations on Subfloor.

Assembly No. 8

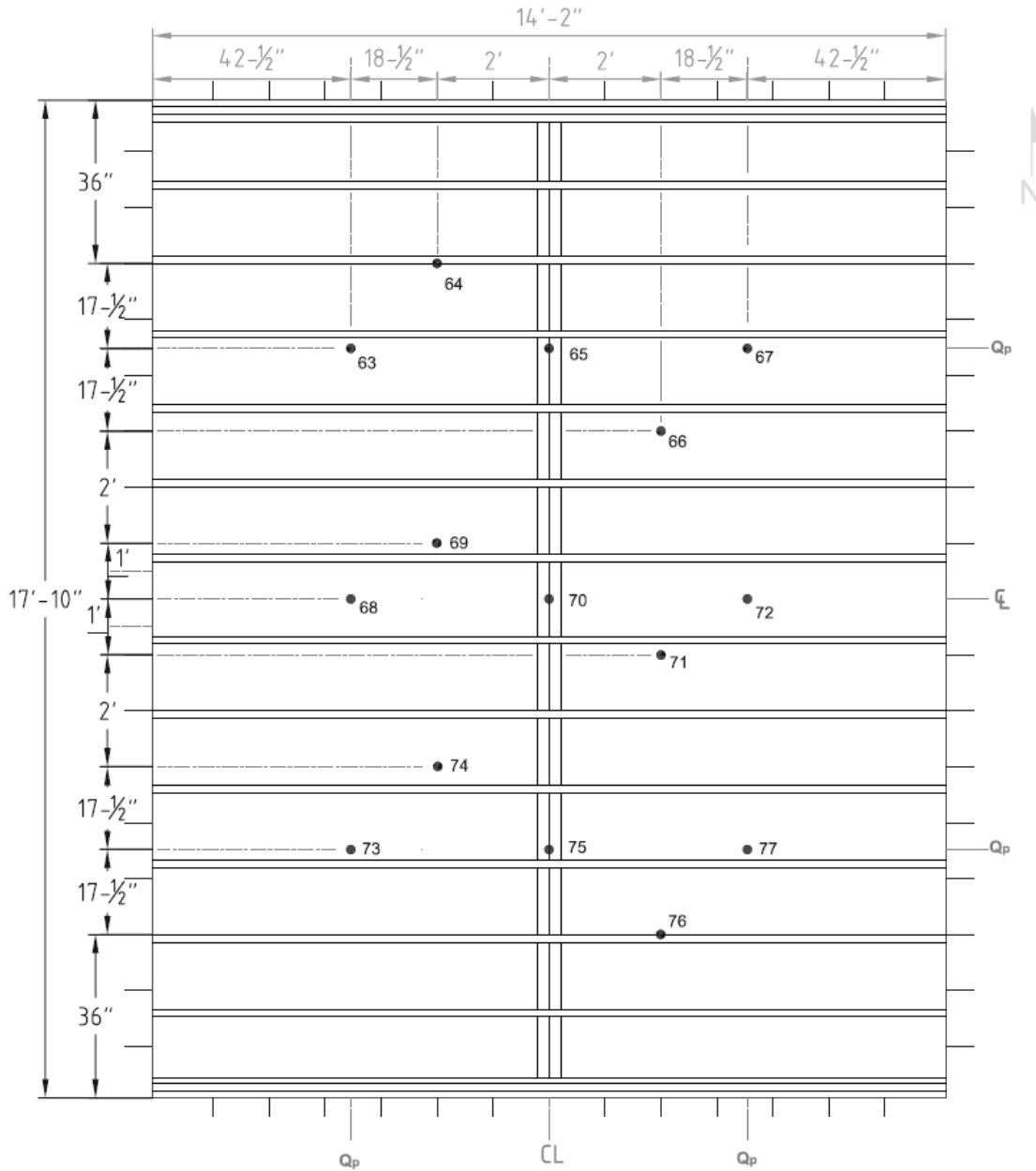

Figure A.8.6 – Thermocouple Locations on Unexposed Surface.

Assembly No. 8

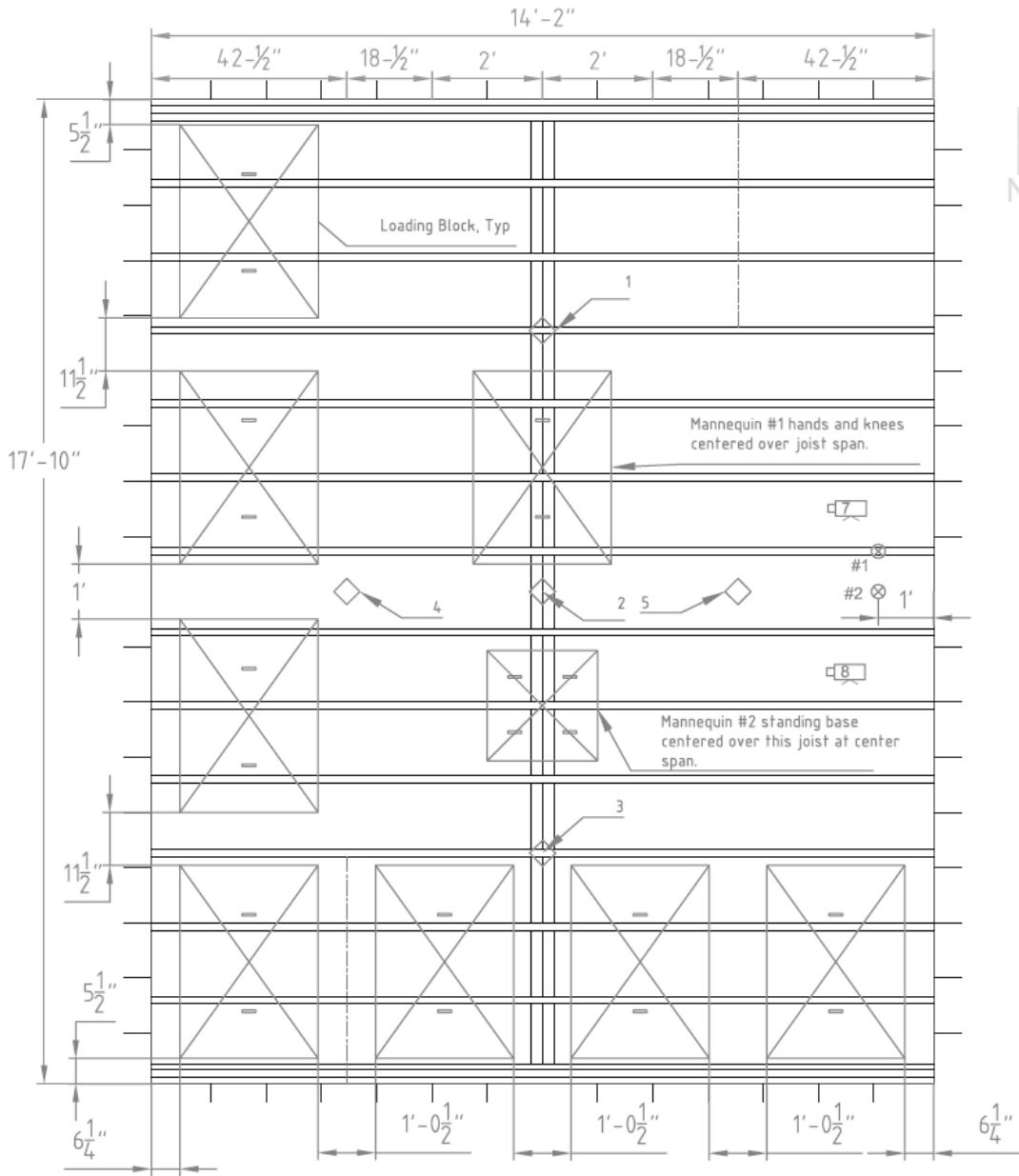

Figure A.8.7 – Loading and Instrumentation Layout (See Figure A.8.8).

Assembly No. 8

Deflection Transducers:



- 1 - Along E-W Centerline, North Quarter-point.
- 2 - Along E-W Centerline, Center-point.
- 3 - Along E-W Centerline, South Quarter-point.
- 4 - Along N-S Centerline, East Quarter-point.
- 5 - Along N-S Centerline, West Quarter-point.

Accelerometers:



- 1- Over Joist, 12 in. from East edge of assembly.
- 2- Over Center of Span, 12 in. from East edge of assembly.

Audio Recordings: (Not Shown)

- 1 - Mannequin No. 1 (Hands & Knees)
- 2 - Mannequin No. 2 (Standing)

Video Camera Recordings: (Not Shown)

- Channel 1409 - floor level view from northeast corner
- Channel 1411 - IR camera from curing cell roof east center
- Channel 1412 - furnace camera from northwest corner
- Channel 1416 - overhead from east center of assembly
- Channel 1413 - overhead from south center of assembly
- Channel 1503 - overhead from west center of assembly

Video Camera Recordings:



- Channel 1415 - internal camera east (installed in joist cavity 6 from north facing west - under kneeling mannequin #1.
- Channel 1502 - internal camera east (installed in joist cavity 8 from north facing west -under standing mannequin #2.

Furnace Pressure Probes: (Not Shown)

- 1 - located near plate thermocouple No. 79

Oxygen Content : (Not Shown)

located in E exhaust duct.

Bi-directional Probe & 1.0 mm diameter thermocouple 80

80 - located near plate thermocouple No. 78. (Not shown)

Figure A.8.8 – Loading and Instrumentation Key

Assembly No. 9

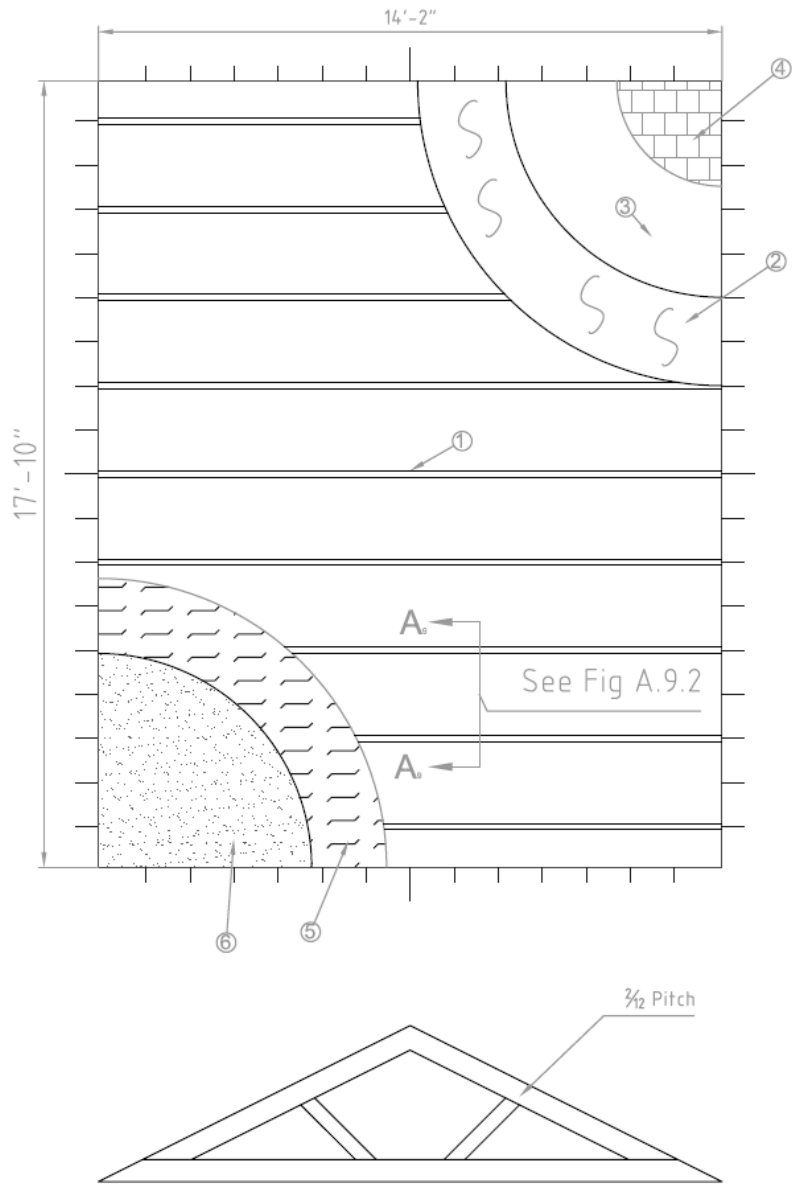

Figure A.9.1 – Construction Layout

Assembly No. 9

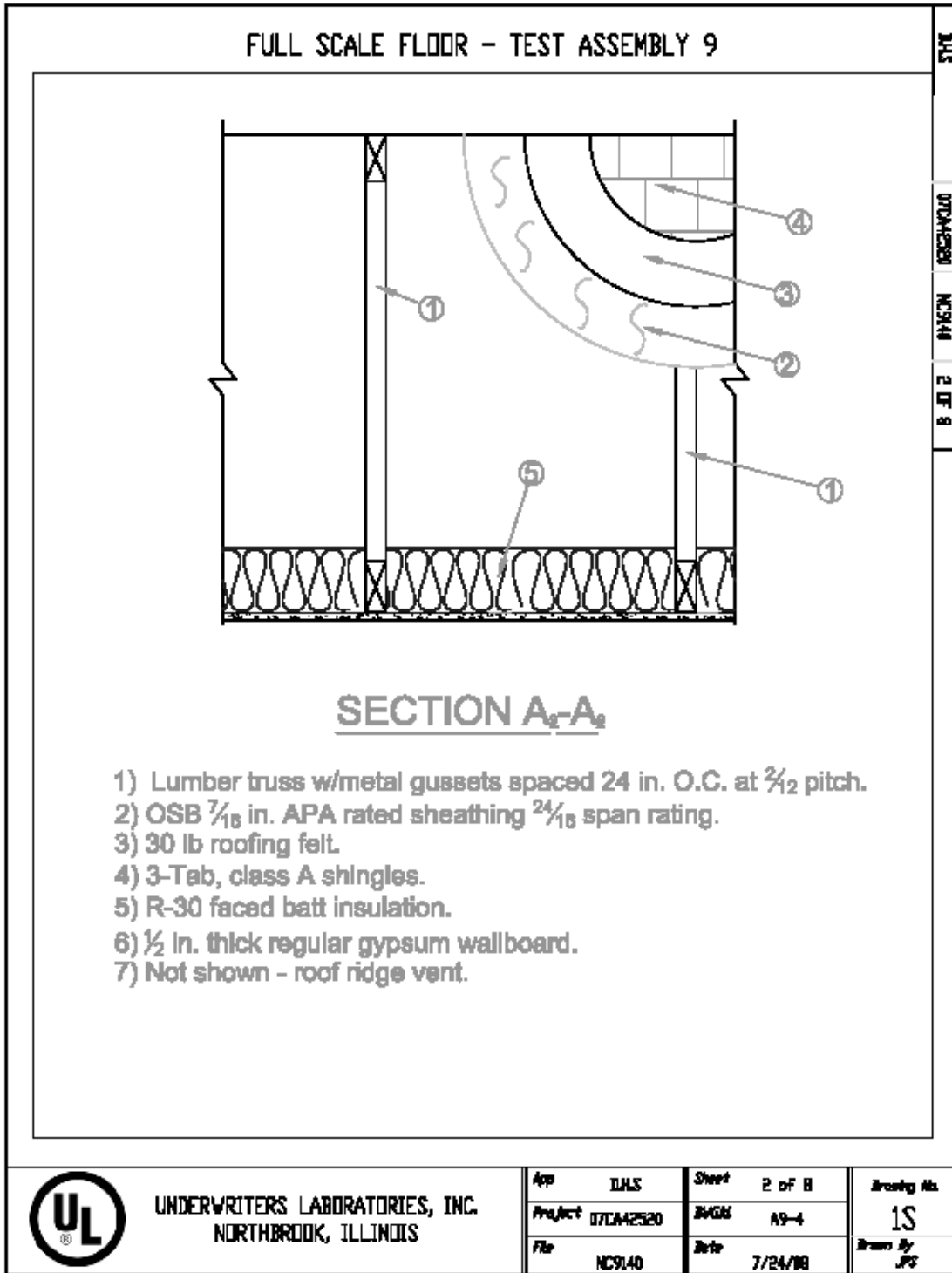

Figure A.9.2 – Construction Layout Section A₉-A₉.

Assembly No. 9

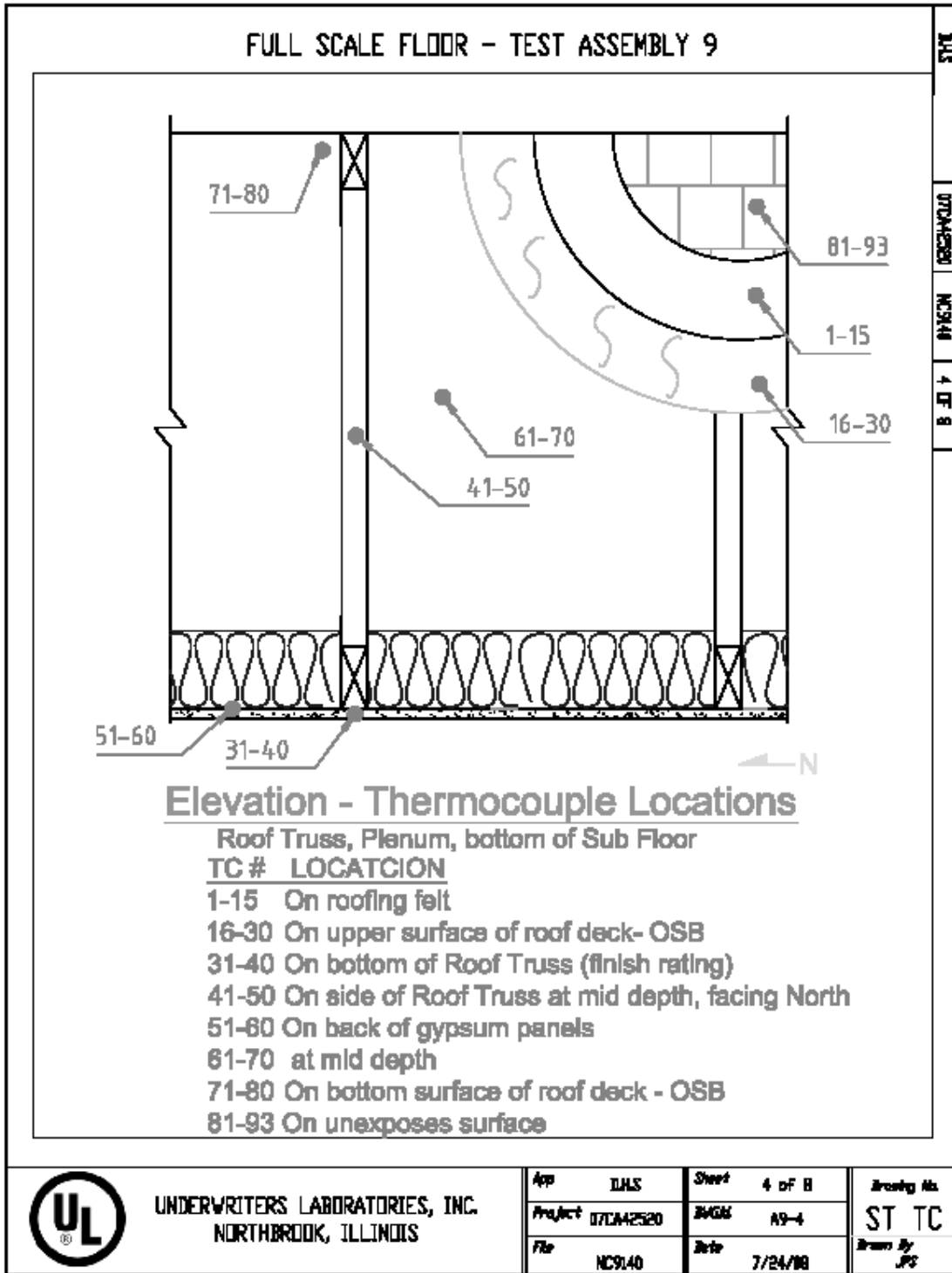
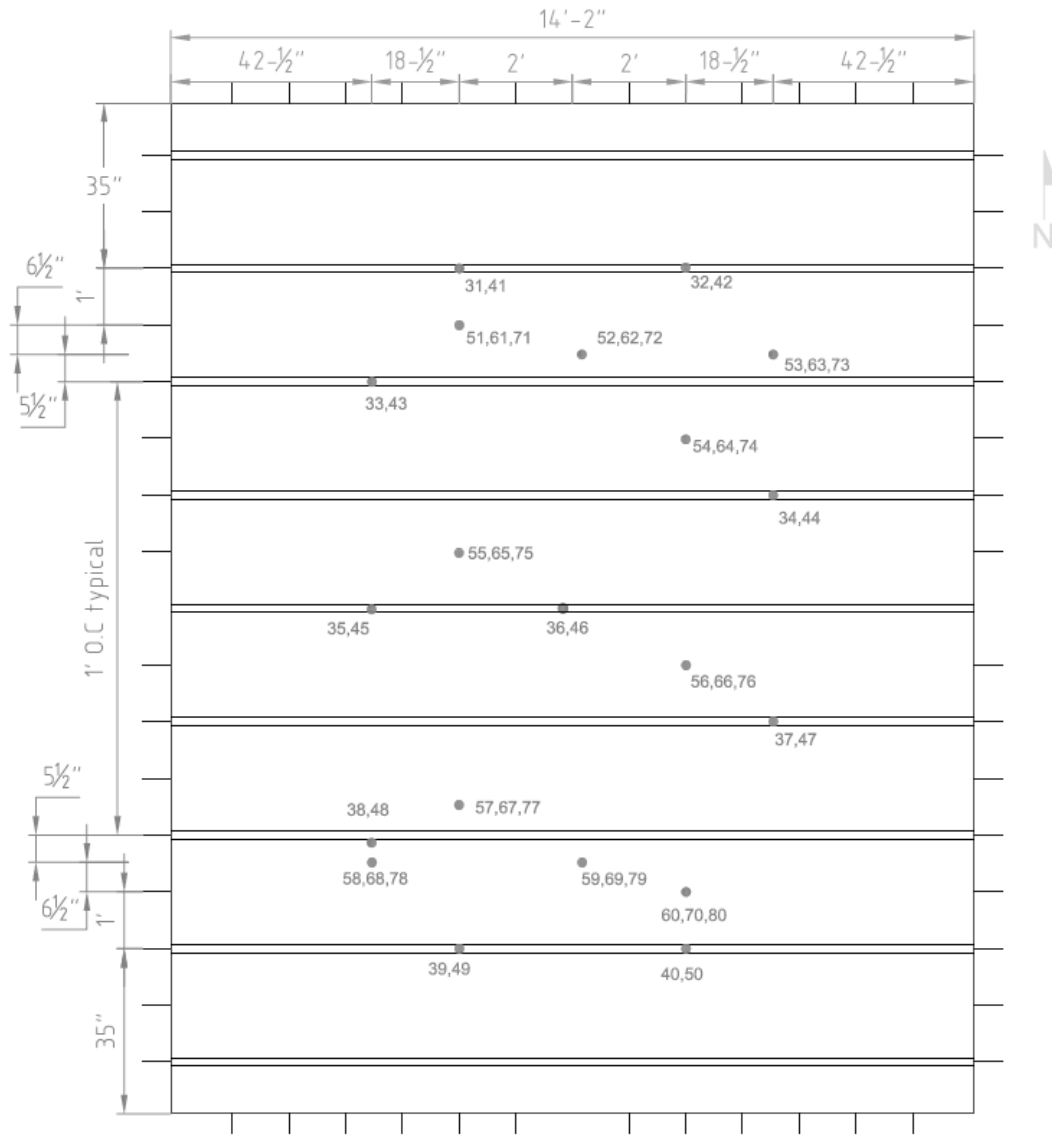

Figure A.9.3 – Thermocouple Locations - Elevation.

Assembly No. 9



Note:
T.C.'s 72 & 79 Moved 2 In. West
due to sheathing cut short from ridge.

Figure A.9.4 – Thermocouple Locations on Wood Members.

Assembly No. 9

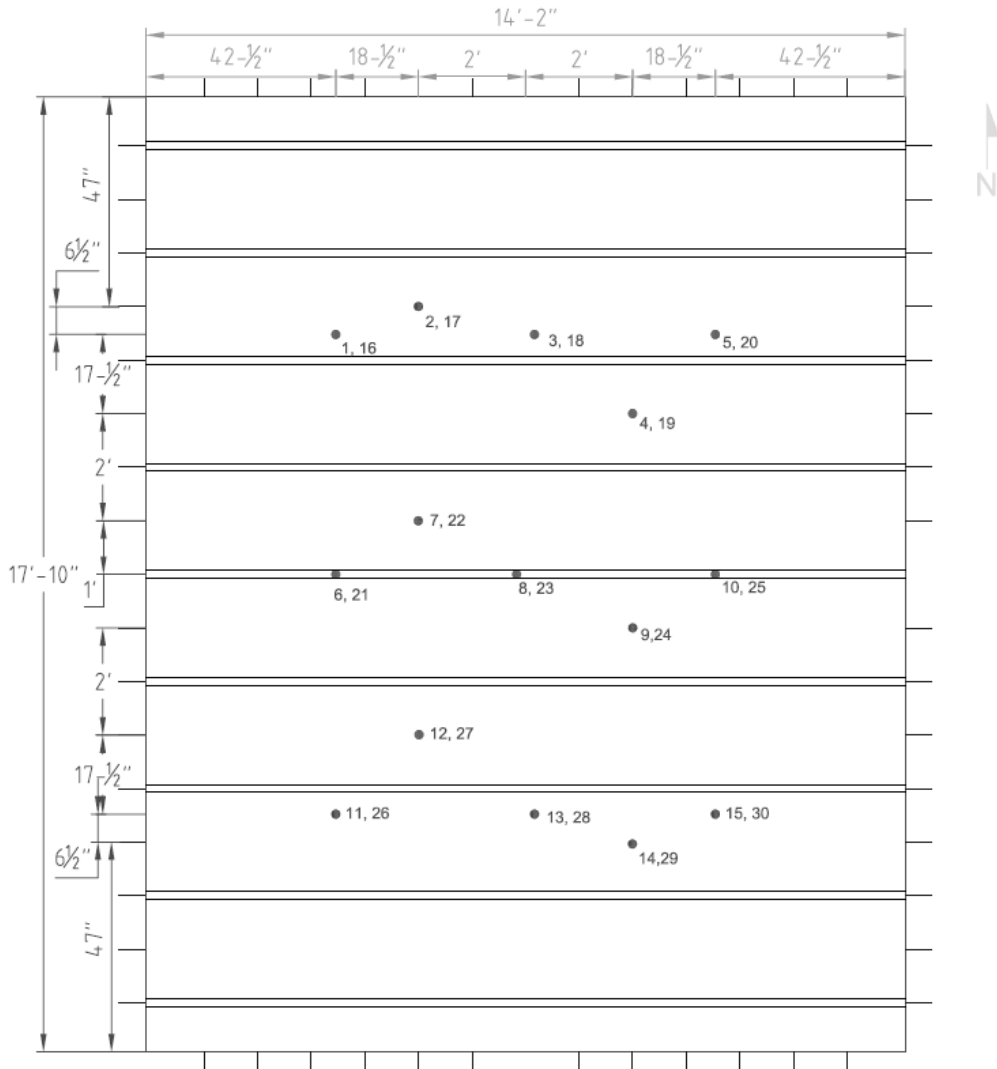

Note:
T.C.'s 3,13,18 & 28 moved 2 In. West.
T.C.'s 8,23 moved 2 in. East
Due to sheathing Being Cut short from
ridge.

Figure A.9.5 – Thermocouple Locations on Roof Subfloor and Roof Felt.

Assembly No. 9

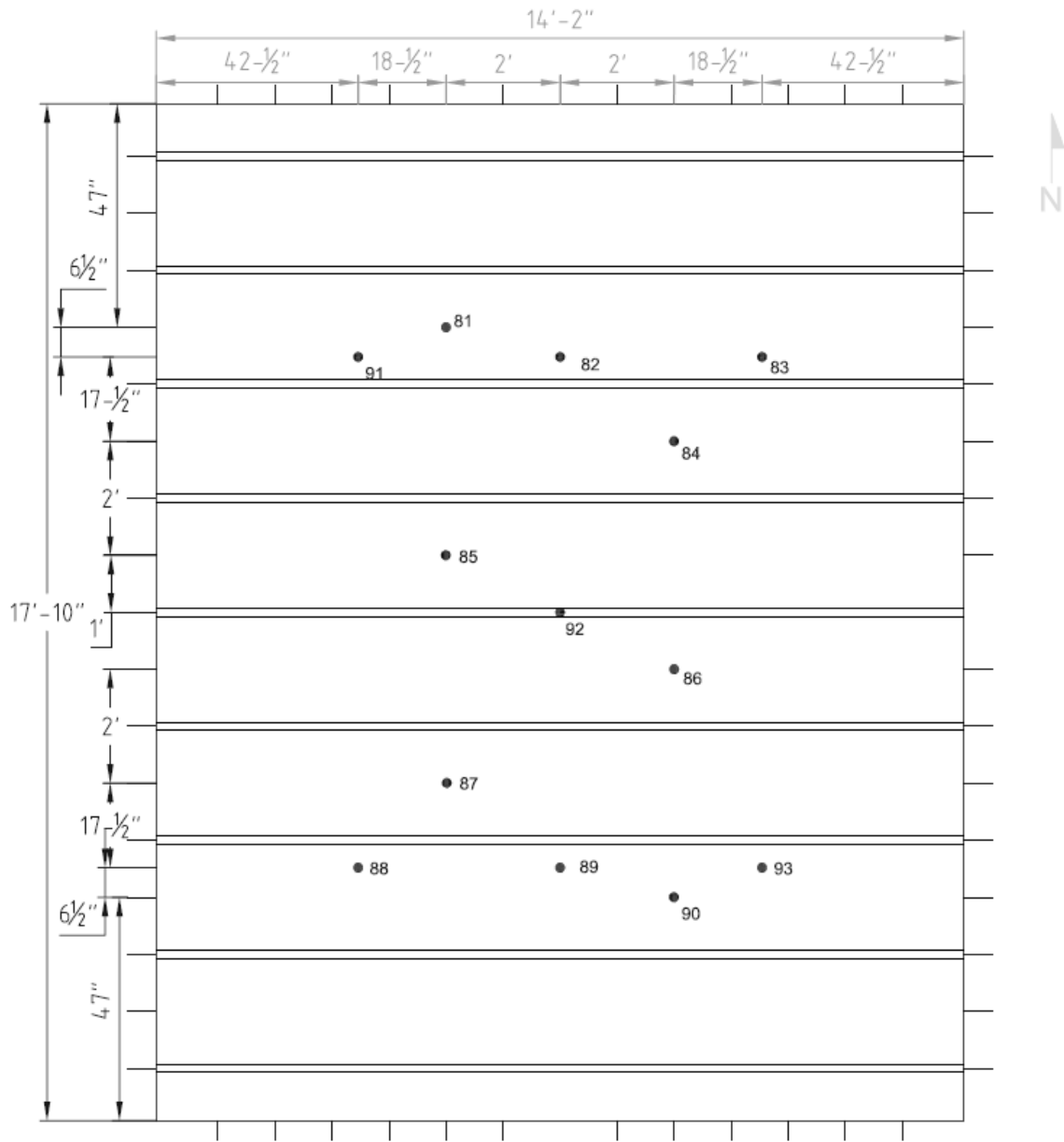

Figure A.9.6 – Thermocouple Locations on Unexposed Surface.

Assembly No. 9

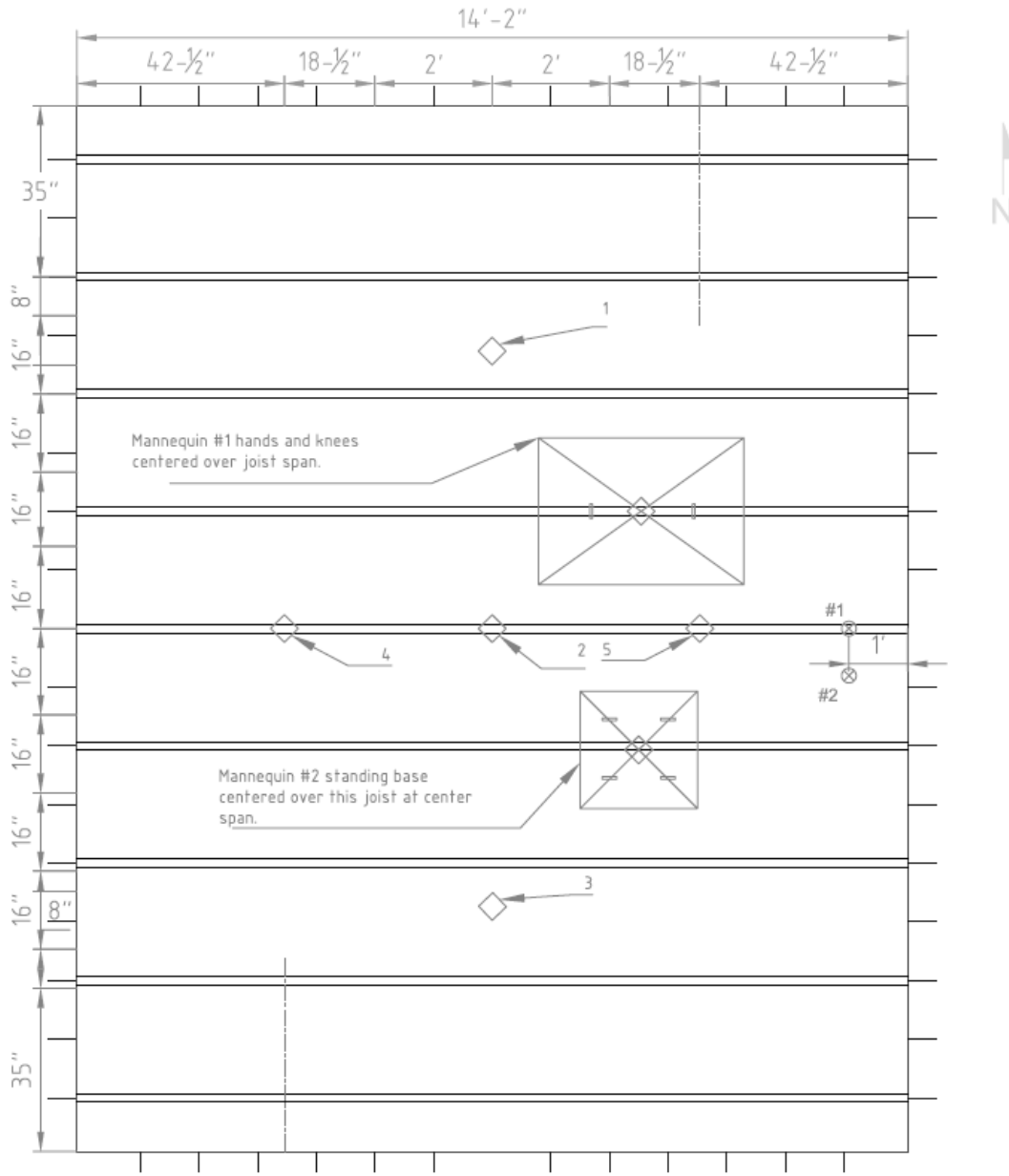

Figure A.9.7 – Loading and Instrumentation Layout (See Figure A.9.8).

Assembly No. 9**Deflection Transducers:** 

- 1 - Along E-W Centerline, North Quarter-point.
- 2 - Along E-W Centerline, Center-point.
- 3 - Along E-W Centerline, South Quarter-point.
- 4 - Along N-S Centerline, East Quarter-point.
- 5 - Along N-S Centerline, West Quarter-point.

Accelerometers: 

- 1- Over rafter, 12 in. from East edge of assembly.
- 2- Over Center of Span, 12 in. from East edge of assembly.

Audio Recordings: (Not Shown)

- 1 - Mannequin No. 1 (Hands & Knees)
- 2 - Mannequin No. 2 (Standing)

Video Camera Recordings: (Not Shown)

- Channel 1409 - floor level view from northeast corner
- Channel 1411 - IR camera from curing cell roof east center
- Channel 1412 - furnace camera from northwest corner
- Channel 1416 - overhead from east center of assembly
- Channel 1413 - overhead from south center of assembly
- Channel 1503 - overhead from west center of assembly

Video Camera Recordings: 

- Channel 1415 - internal camera east (installed in joist cavity 6 from north facing west - under kneeling mannequin #1.
- Channel 1502 - internal camera east (installed in joist cavity 8 from north facing west -under standing mannequin #2.

Furnace Pressure Probes: (Not Shown)

- 1 - located near plate thermocouple No. 95

Oxygen Content : (Not Shown)

located in E exhaust duct.

Bi-directional Probe & 1.0 mm diameter thermocouple (Not Shown)

- 96- located near plate thermocouple No. 94

Figure A.9.8 – Loading and Instrumentation Key