

MACRO STORM WATER DRAINAGE STUDY

Tailormade Landing
Lot 2, Williams Crossing
SITE ACREAGE: 8.29 ACRES

Lee's Summit, MO

PREPARED BY:



Submittal Date: January 2, 2018

Revision

Date	Comment	By
4-24-18	Revised Outlet Structure & Basin	AEP
5-14-18	Revised Basin Grading Added Emergency Spillway Added Drainage Maps Added Soil Data TC Discussion & Calcs CN Discussion & Calcs	AEP
6-6-18	Sub-basin Discussion & Calcs	AEP
7-24-18	Revised Per City Comments Dated 7-17-18	AEP

Matthew J. Schlicht, PE

TABLE OF CONTENTS

- 1. REPORT COVER SHEET**
- 2. TABLE OF CONTENTS**
- 3. GENERAL INFORMATION**
- 4. METHODOLOGY**
- 5. EXISTING CONDITION ANALYSIS**
- 6. PROPOSED CONDITION ANALYSIS**
- 7. FUTURE CONDITIONS ANALYSIS**
 - 7.1 DETENTION**
- 8. CONCLUSIONS & RECOMMENDATIONS**
- 9. EXHIBITS**

3. GENERAL INFORMATION

The proposed project is located at 1600 SE Hamblen Road. The site contains 8.29 acres. The objective of the proposed Tailormade Landing development is to improve the existing Tailormade commercial lot which is located generally in the southwest/west area of the property. Proposed improvements consist of a new building addition, paved parking and new drive aisle along with associated utility infrastructure. The future condition calls for the development of 5 additional commercial lots on the property. The proposed detention facility to be constructed in the proposed development phase shall be designed to control the entire 8.29 acres of future commercial development. The majority of the property is grass covered. The site will meet the APWA Section 5600 storm drainage requirements utilizing the Detention Facility located at the northeast corner of the site. The site generally drains from southwest to northeast. See Exhibit A for an aerial image of the proposed project site along with an aerial image of the surrounding area.

4. METHODOLOGY

NRCS Soil Classification

Soil classifications published by the United States Department of Agriculture/National Resources Conservation Service (USDA/NRCS) website for Jackson County, Missouri on September 16, 2017, the existing site contains two major soil types:

10082 Arisburg-Urban land complex, 1 to 5 percent slopes
Hydrologic Soil Group (HSG): Type C

10180 Udarents-Urban land-Sampsel complex, 2 to 5 percent slopes
HSG: Type C

HSG Type C soils correspond to APWA Curve number coefficients i.e., turf = 74, gravel = 89 and Impervious (Roof & Pavement) = 98. See Exhibit B for a detailed soils report of the proposed project site.

Curve Numbers

The existing and proposed land usage conditions on the site consist of turf/wooded areas, gravel and impervious (roof/paved) areas. Curve numbers represent the amount of runoff that should be anticipated from a given land usage. The following curve numbers have been utilized in this study based upon the soils present and the given land uses.

Turf/Wooded Areas, CN = 74

Gravel Areas, CN = 89

Impervious Areas (Roof & Pavement), CN = 98

Watersheds typically contain a mixture of land uses with varied curve numbers. In order to calculate runoff for a given watershed a composite curve number is calculated which consists of area weighted curve numbers. Drainage maps both existing and proposed are enclosed at the end of the report which detail the land usage for tributary areas both on and offsite. See Exhibit C for a detailed composite curve analysis for both existing and proposed conditions. The Future buildout condition for the property consisting of 6 commercial lots will be assumed to have a 94 curve number.

Time of Concentration, T_c

Time of concentration is the time it takes for the most hydraulically distant point in the watershed to reach the point of interest. When the time of concentration is reached it is assumed that the entire

watershed is contributing flow to the point of interest and peak flow may be calculated for a given design storm. Overland, shallow concentrated and channelized flow portions which make up the Tc have been depicted for each watershed on the appropriate drainage map at the end of the report. See Exhibit D for complete Tc calculations.

5. EXISTING CONDITIONS ANALYSIS

The Existing condition consists of the property as it exists today which includes the Tailormade commercial building along with gravel parking and drive. The majority of the property is grass covered. The site consists one sub-basin referred to as Sub-basin A for the purposes of this report. Sub-basin A contains the entire project property being developed along with additional offsite property upstream to the west and south. Sub-basin A consists of 19.17 total acres, 8.29 onsite and 10.88 offsite. Sub-basin A drains to an existing field inlet located in the northeast section of the property adjacent to Hamblen Road. The existing field inlet shall be referred to as Point of Interest A for the purposes of this report.

The following tables summarize the results of the Existing Conditions Analysis. An Existing Conditions Land Usage Map may be found in Exhibit E which was utilized to help determine composite curve numbers for each sub-basin. An Existing Conditions Drainage Map may be found in Exhibit F.

Table 5-1 Existing Conditions Sub-basin Data

Sub-basin	Area (ac.)	Composite CN	Tc (min.)
A	19.17	78	20.9

Table 5-2 Existing Conditions Sub-basin/Point of Interest Peak Discharge Rates

Sub-basin	Q2 (cfs)	Q10 (cfs)	Q100 (cfs)
A	31.54	61.65	108.59

The City requires a Comprehensive Runoff Control Strategy per APWA 5608.4. Comprehensive Control requires that Post-Development peak discharge rates from the site shall not exceed those indicated below regardless of Pre-Development land usage.

- 50% storm peak rate less than or equal to 0.5 cfs per site acre.
- 10% storm peak rate less than or equal to 2.0 cfs per site acre.
- 1% storm peak rate less than or equal to 3.0 cfs per site acre.

Allowable release rates were calculated at each Point of Interest, allowing that offsite peak discharges would be permitted to bypass detention requirements. Offsite bypass peak flow rates were calculated as a percentage of the existing conditions, relating to the percentage of offsite area flowing to each point. Release rates for the proposed development onsite were calculated in accordance with stated detention criteria. The development release rates were added to the bypass peak flow rates to calculate an allowable peak flow rate at each Point of Interest.

Table 5-3 Point of Interest Offsite Area

Point of Interest	Total Area (ac.)	Onsite Area (ac.)	Percentage Offsite
A	19.17	8.29	56.8%

Table 5-4 Point of Interest Allowable Peak Flow Rates

Point of Interest	Allowable Q2 (cfs)	Allowable Q10 (cfs)	Allowable Q100 (cfs)
A	22.06	51.60	86.55

A Hydraflow analysis was completed to determine the various peak discharge rates. A complete Hydraflow Report may be found in Exhibit G which includes Existing, Proposed and Future conditions.

6. PROPOSED CONDITIONS ANALYSIS

The Proposed condition consists of a building expansion for Tailormade along with new asphalt parking, drive and associated utility infrastructure. The remaining area consisting of 5 future commercial lots and the detention area shall remain grass covered. A Proposed Conditions Land Usage Map may be found in Exhibit G which was utilized to help determine composite curve numbers for each sub-basin. A Proposed Conditions Drainage Area Map may be found in Exhibit H.

The following tables contain input data and summarize the computed results from the Hydraflow Analysis for the Proposed Conditions. The Proposed Conditions peak discharge rates will be compared to the Allowable Release Rates. Any change in the peak discharge rates will be directly attributable to the proposed development onsite.

Table 6-1 Proposed Conditions Sub-basin Data

Sub-basin	Area (ac.)	Composite CN	Tc (min.)
A	19.17	79	20.9

Table 6-2 Proposed Conditions Sub-basin/Point of Interest Peak Discharge Rates

Sub-basin	Q2 (cfs)	Q10 (cfs)	Q100 (cfs)
A	33.14	63.62	110.78

As shown above the Proposed Conditions Peak Discharge Rates to Point of Interest A are considerably higher than the calculated Allowable Release Rates therefore a detention facility would be required to reduce the Proposed Condition Peak Flows below Allowable. However as previously stated the goal is to design and construct a detention facility that will reduce peak flows from Future Conditions at or below Allowable.

7. FUTURE CONDITIONS ANALYSIS

The Future Condition (Ultimate Buildout) consists of developing an additional 5 commercial lots on the subject property. The commercial lots are assumed to have a curve number of 94. The area reserved for the detention basin is 0.70 acres and has a curve number of 74.

The following tables contain input data and summarize the computed results from the Hydraflow Analysis for Future Conditions. Any change in the peak discharge rates will be directly attributable to the proposed future development onsite.

Table 7-1 Future Conditions Sub-basin Data

Sub-basin	Area (ac.)	Composite CN	Tc (min.)
A	19.17	85	19.8

Table 7-2 Future Conditions Sub-basin/Point of Interest Peak Discharge Rates

Sub-basin	Q2 (cfs)	Q10 (cfs)	Q100 (cfs)
A	44.92	78.23	127.64

The existing control structure is not adequate to route the entire Future Sub-basin A through the proposed detention facility and meet all applicable design criteria such as 100-year clogged and non-clogged flow conditions. In order to meet allowable release rates as outlined in Table 4-4 above Sub-basin A will be divided into two sub-basins, Sub-basin A and Sub-basin A1. Sub-basin A will bypass

the detention basin and Sub-basin A1 will be routed through the proposed detention facility. The combination of un-detained Sub-basin A and detained Sub-basin A1 peak discharge rates must be reduced below allowable release rates. A Future Conditions Drainage Area Map may be found in Exhibit I.

The following tables contain input data and summarize the computed results from the Hydraflow Analysis for Future Conditions for Sub-basin A and Sub-basin A1. The Future Conditions peak discharge rates will be compared to Allowable Release Rates to confirm conformance with all applicable design criteria.

Table 7-3 Future Conditions Sub-basin Data

Sub-basin	Area (ac.)	Composite CN	Tc (min.)
A	10.12	85	19.8
A1	9.06	85	19.0

Table 7-4 Future Conditions Sub-basin Peak Discharge Rates

Sub-basin	Q2 (cfs)	Q10 (cfs)	Q100 (cfs)
A	23.71	41.30	67.38
A1	22.06	37.87	61.21

7.1 DETENTION

A new earthen detention basin is being proposed in Sub-basin A1 to attenuate peak discharge rates. The basin shall be grass lined with maximum side slopes of 3:1 and a minimum bottom slope of 2%. The bottom elevation is 1003.20 at the 24" HDPE inlet pipe. The top of berm elevation is 913.50. The basin has a maximum storage volume of 151,899 cubic feet. The outlet structure will consist of a 5' wide by 5' deep rectangular concrete box structure with 6" interior weir wall. Three orifices will be placed in the weir wall. A 2" diameter circular orifice at elevation 1003.10 utilized to release the 1.37" Water Quality event over a minimum 40 hour timeframe. 40-Hour Release Calculations for the Water Quality event are provided in Exhibit J. The 2" orifice will be shielded by a trash rack upstream to help minimize clogging and routine maintenance. The second and third orifices shall both consist of a 12" dia. circular orifice at elevation 1008.10. One 12" orifice has been cored at the factory. The second 12" dia. orifice shall be cored in the field and be equidistant from the side wall and center orifice. The interior weir wall crest elevation shall be 1012.60. The top of the structure shall be at 1013.60. The effective crest length for the emergency spillway rectangular weir on the outlet control structure shall be 9.5'. However due to necessary changes in the outlet control structure the emergency spillway will only operate in storm events beyond the back to back 100-yr clogged event. The control structure outlet pipe shall be a 24" HDPE at 3.28% slope. The Detention Basin Plan may be found in Exhibit K.

An emergency spillway consisting of an 80 linear foot broad crested weir shall be located along the eastern berm of Detention Basin A1. The crest elevation shall be 1012.00 which is more than 6 inches higher than the 100-yr water surface elevation of 1011.49. The emergency spillway was analyzed to determine both flowrate and hydraulic grade line of the 100-yr storm event assuming the primary outlet structure is 100% plugged and there is zero available storage in the basin. The earthen weir will convey the 100 year peak discharge of 61.21 cfs. A freeboard of 1-foot is required from the spillway HGL to the top of berm. The proposed bypass HGL is 1012.44 providing 1.06 feet of freeboard to the top of basin at 1013.50. The maximum velocity from the earthen weir is 1.73 feet per second which will allow the weir and spillway to be turf lined. Basin A1 emergency spillway calculations may be found at the end of Exhibit L which also contains the complete Hydraflow Analysis. An inlet pipe analysis is also provided at the end of Exhibit L. See Table 7-5 for a summary of detention basin data.

Table 7-5 Future Conditions Detention Basin Data

	Peak Qin (cfs)	Tp In (min.)	Peak Qout (cfs)	Tp Out (min.)	Peak W.S.E.	Max. Storage (cf)
Basin A1						
2-Year	22.06	725	0.92	882	1008.36	46,253
10-Year	37.87	725	8.01	745	1009.47	62,953
100-Year	61.21	724	14.44	744	1011.49	101,365

As shown in the table above all proposed peak flowrates have been attenuated. See Table 7-6 below for a summary of proposed peak discharge rates at point of interest A. Hydrographs tributary to each point of interest have been combined to determine subsequent peak discharge rates.

Table 7-6 Future Conditions Point of Interest Peak Discharge Rates

Point of Interest	Q2 (cfs)	Q10 (cfs)	Q100 (cfs)
A	23.91	41.55	77.80

The following table provides a comparison of runoff data between Future, Existing and Allowable conditions.

Table 7-7 Point of Interest Peak Discharge Comparison

		Q2 (cfs)	Q10 (cfs)	Q100 (cfs)
Point A	Future	23.91	41.55	77.80
	Existing	31.54	61.65	108.59
	Difference	-7.63	-20.10	-30.79
	Allowable	22.06	51.60	86.55
	Difference	1.85	-10.05	-8.75

Peak discharge rates at Point A will be reduced below allowable for the 10 and 100-yr events and well below existing for the 2-yr event. Future lots 2, 4 and 6 will not be detained in the future along with the north portion of Lot 5. The Tailormade lot along with Lot 3 will be fully detained along with a significant portion of offsite property.

8. Conclusions & Recommendations

This macro storm water drainage study shows that the improvements to the Tailormade lot in addition to the development of Tailormade Landing commercial district in the future will not generate any negative downstream hydraulic impacts. A new earthen detention basin located generally in the northeast corner of the property will provide the required detention for both the proposed and future improvements.

In conclusion, proposed peak discharge rates for the point of interest are below allowable release rates except for the 2-year which is well below existing. The study is in conformance with all applicable City of Lee's Summit standards and criteria therefore Engineering Solutions recommends approval of this macro storm water drainage study.

Exhibit A

Aerial Image of Project Site & Aerial Image of Surrounding Area



PROJECT SITE

SE Kingsport Dr



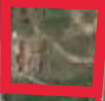
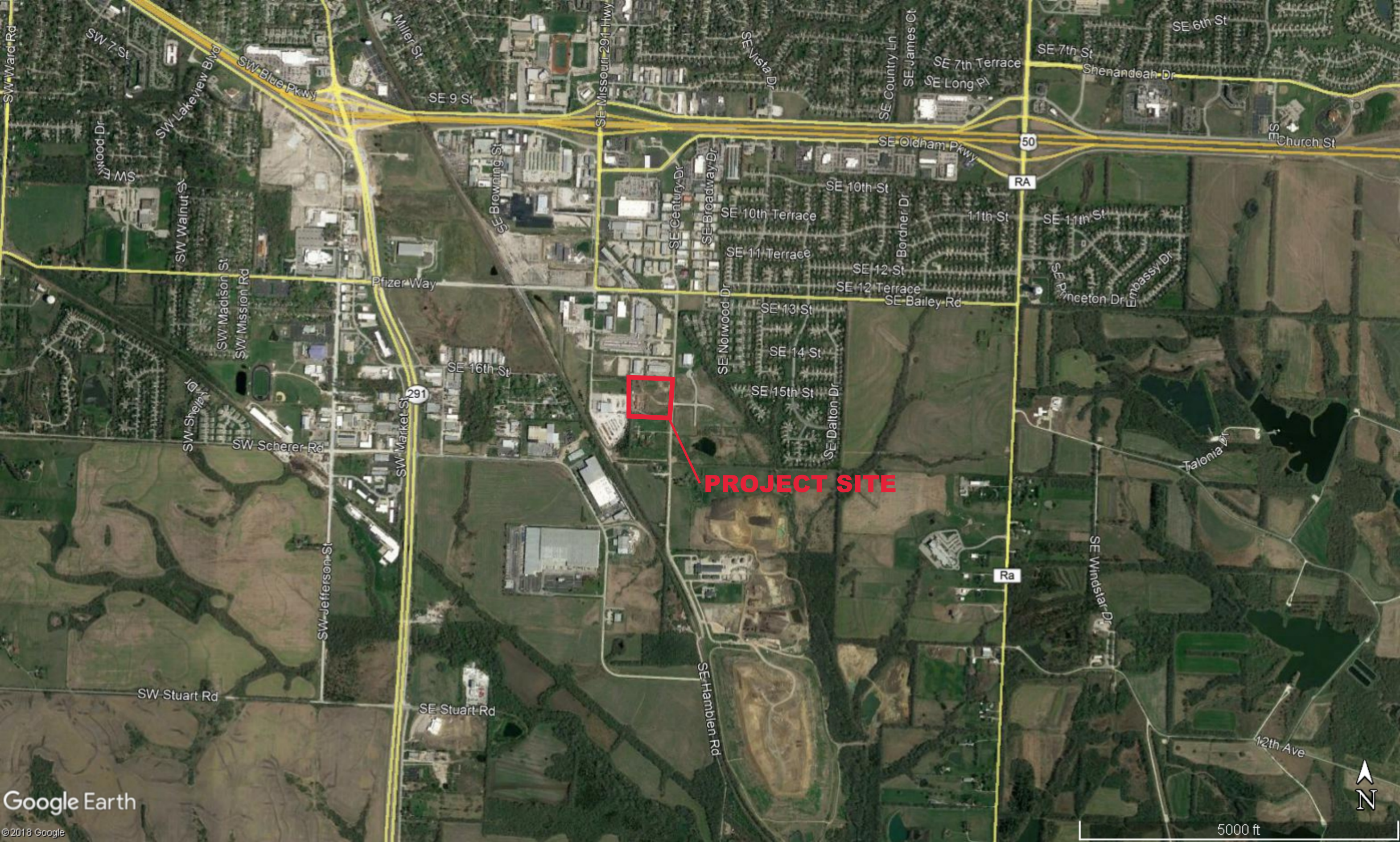

PROJECT SITE

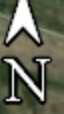

Exhibit B

Soils Report



United States
Department of
Agriculture

NRCS

Natural
Resources
Conservation
Service

A product of the National
Cooperative Soil Survey,
a joint effort of the United
States Department of
Agriculture and other
Federal agencies, State
agencies including the
Agricultural Experiment
Stations, and local
participants

Custom Soil Resource Report for **Jackson County, Missouri**



Preface

Soil surveys contain information that affects land use planning in survey areas. They highlight soil limitations that affect various land uses and provide information about the properties of the soils in the survey areas. Soil surveys are designed for many different users, including farmers, ranchers, foresters, agronomists, urban planners, community officials, engineers, developers, builders, and home buyers. Also, conservationists, teachers, students, and specialists in recreation, waste disposal, and pollution control can use the surveys to help them understand, protect, or enhance the environment.

Various land use regulations of Federal, State, and local governments may impose special restrictions on land use or land treatment. Soil surveys identify soil properties that are used in making various land use or land treatment decisions. The information is intended to help the land users identify and reduce the effects of soil limitations on various land uses. The landowner or user is responsible for identifying and complying with existing laws and regulations.

Although soil survey information can be used for general farm, local, and wider area planning, onsite investigation is needed to supplement this information in some cases. Examples include soil quality assessments (<http://www.nrcs.usda.gov/wps/portal/nrcs/main/soils/health/>) and certain conservation and engineering applications. For more detailed information, contact your local USDA Service Center (<https://offices.sc.egov.usda.gov/locator/app?agency=nrcs>) or your NRCS State Soil Scientist (http://www.nrcs.usda.gov/wps/portal/nrcs/detail/soils/contactus/?cid=nrcs142p2_053951).

Great differences in soil properties can occur within short distances. Some soils are seasonally wet or subject to flooding. Some are too unstable to be used as a foundation for buildings or roads. Clayey or wet soils are poorly suited to use as septic tank absorption fields. A high water table makes a soil poorly suited to basements or underground installations.

The National Cooperative Soil Survey is a joint effort of the United States Department of Agriculture and other Federal agencies, State agencies including the Agricultural Experiment Stations, and local agencies. The Natural Resources Conservation Service (NRCS) has leadership for the Federal part of the National Cooperative Soil Survey.

Information about soils is updated periodically. Updated information is available through the NRCS Web Soil Survey, the site for official soil survey information.

The U.S. Department of Agriculture (USDA) prohibits discrimination in all its programs and activities on the basis of race, color, national origin, age, disability, and where applicable, sex, marital status, familial status, parental status, religion, sexual orientation, genetic information, political beliefs, reprisal, or because all or a part of an individual's income is derived from any public assistance program. (Not all prohibited bases apply to all programs.) Persons with disabilities who require

alternative means for communication of program information (Braille, large print, audiotape, etc.) should contact USDA's TARGET Center at (202) 720-2600 (voice and TDD). To file a complaint of discrimination, write to USDA, Director, Office of Civil Rights, 1400 Independence Avenue, S.W., Washington, D.C. 20250-9410 or call (800) 795-3272 (voice) or (202) 720-6382 (TDD). USDA is an equal opportunity provider and employer.

Contents

Preface	2
How Soil Surveys Are Made	5
Soil Map	8
Soil Map.....	9
Legend.....	10
Map Unit Legend.....	11
Map Unit Descriptions.....	11
Jackson County, Missouri.....	13
10082—Arisburg-Urban land complex, 1 to 5 percent slopes.....	13
10180—Udarents-Urban land-Sampsel complex, 2 to 5 percent slopes....	14
References	17

How Soil Surveys Are Made

Soil surveys are made to provide information about the soils and miscellaneous areas in a specific area. They include a description of the soils and miscellaneous areas and their location on the landscape and tables that show soil properties and limitations affecting various uses. Soil scientists observed the steepness, length, and shape of the slopes; the general pattern of drainage; the kinds of crops and native plants; and the kinds of bedrock. They observed and described many soil profiles. A soil profile is the sequence of natural layers, or horizons, in a soil. The profile extends from the surface down into the unconsolidated material in which the soil formed or from the surface down to bedrock. The unconsolidated material is devoid of roots and other living organisms and has not been changed by other biological activity.

Currently, soils are mapped according to the boundaries of major land resource areas (MLRAs). MLRAs are geographically associated land resource units that share common characteristics related to physiography, geology, climate, water resources, soils, biological resources, and land uses (USDA, 2006). Soil survey areas typically consist of parts of one or more MLRA.

The soils and miscellaneous areas in a survey area occur in an orderly pattern that is related to the geology, landforms, relief, climate, and natural vegetation of the area. Each kind of soil and miscellaneous area is associated with a particular kind of landform or with a segment of the landform. By observing the soils and miscellaneous areas in the survey area and relating their position to specific segments of the landform, a soil scientist develops a concept, or model, of how they were formed. Thus, during mapping, this model enables the soil scientist to predict with a considerable degree of accuracy the kind of soil or miscellaneous area at a specific location on the landscape.

Commonly, individual soils on the landscape merge into one another as their characteristics gradually change. To construct an accurate soil map, however, soil scientists must determine the boundaries between the soils. They can observe only a limited number of soil profiles. Nevertheless, these observations, supplemented by an understanding of the soil-vegetation-landscape relationship, are sufficient to verify predictions of the kinds of soil in an area and to determine the boundaries.

Soil scientists recorded the characteristics of the soil profiles that they studied. They noted soil color, texture, size and shape of soil aggregates, kind and amount of rock fragments, distribution of plant roots, reaction, and other features that enable them to identify soils. After describing the soils in the survey area and determining their properties, the soil scientists assigned the soils to taxonomic classes (units). Taxonomic classes are concepts. Each taxonomic class has a set of soil characteristics with precisely defined limits. The classes are used as a basis for comparison to classify soils systematically. Soil taxonomy, the system of taxonomic classification used in the United States, is based mainly on the kind and character of soil properties and the arrangement of horizons within the profile. After the soil

Custom Soil Resource Report

scientists classified and named the soils in the survey area, they compared the individual soils with similar soils in the same taxonomic class in other areas so that they could confirm data and assemble additional data based on experience and research.

The objective of soil mapping is not to delineate pure map unit components; the objective is to separate the landscape into landforms or landform segments that have similar use and management requirements. Each map unit is defined by a unique combination of soil components and/or miscellaneous areas in predictable proportions. Some components may be highly contrasting to the other components of the map unit. The presence of minor components in a map unit in no way diminishes the usefulness or accuracy of the data. The delineation of such landforms and landform segments on the map provides sufficient information for the development of resource plans. If intensive use of small areas is planned, onsite investigation is needed to define and locate the soils and miscellaneous areas.

Soil scientists make many field observations in the process of producing a soil map. The frequency of observation is dependent upon several factors, including scale of mapping, intensity of mapping, design of map units, complexity of the landscape, and experience of the soil scientist. Observations are made to test and refine the soil-landscape model and predictions and to verify the classification of the soils at specific locations. Once the soil-landscape model is refined, a significantly smaller number of measurements of individual soil properties are made and recorded. These measurements may include field measurements, such as those for color, depth to bedrock, and texture, and laboratory measurements, such as those for content of sand, silt, clay, salt, and other components. Properties of each soil typically vary from one point to another across the landscape.

Observations for map unit components are aggregated to develop ranges of characteristics for the components. The aggregated values are presented. Direct measurements do not exist for every property presented for every map unit component. Values for some properties are estimated from combinations of other properties.

While a soil survey is in progress, samples of some of the soils in the area generally are collected for laboratory analyses and for engineering tests. Soil scientists interpret the data from these analyses and tests as well as the field-observed characteristics and the soil properties to determine the expected behavior of the soils under different uses. Interpretations for all of the soils are field tested through observation of the soils in different uses and under different levels of management. Some interpretations are modified to fit local conditions, and some new interpretations are developed to meet local needs. Data are assembled from other sources, such as research information, production records, and field experience of specialists. For example, data on crop yields under defined levels of management are assembled from farm records and from field or plot experiments on the same kinds of soil.

Predictions about soil behavior are based not only on soil properties but also on such variables as climate and biological activity. Soil conditions are predictable over long periods of time, but they are not predictable from year to year. For example, soil scientists can predict with a fairly high degree of accuracy that a given soil will have a high water table within certain depths in most years, but they cannot predict that a high water table will always be at a specific level in the soil on a specific date.

After soil scientists located and identified the significant natural bodies of soil in the survey area, they drew the boundaries of these bodies on aerial photographs and

Custom Soil Resource Report

identified each as a specific map unit. Aerial photographs show trees, buildings, fields, roads, and rivers, all of which help in locating boundaries accurately.

Soil Map

The soil map section includes the soil map for the defined area of interest, a list of soil map units on the map and extent of each map unit, and cartographic symbols displayed on the map. Also presented are various metadata about data used to produce the map, and a description of each soil map unit.

Custom Soil Resource Report Soil Map



Map Scale: 1:1,610 if printed on A landscape (11" x 8.5") sheet.

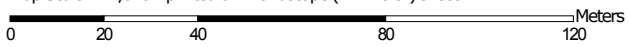

Map projection: Web Mercator Corner coordinates: WGS84 Edge tics: UTM Zone 15N WGS84



MAP LEGEND

Area of Interest (AOI)

 Area of Interest (AOI)



















Soils







 Soil Map Unit Polygons

 Soil Map Unit Lines

 Soil Map Unit Points

Special Point Features





-  Blowout
-  Borrow Pit
-  Clay Spot
-  Closed Depression
-  Gravel Pit
-  Gravelly Spot
-  Landfill
-  Lava Flow
-  Marsh or swamp
-  Mine or Quarry
-  Miscellaneous Water
-  Perennial Water
-  Rock Outcrop
-  Saline Spot
-  Sandy Spot
-  Severely Eroded Spot
-  Sinkhole
-  Slide or Slip
-  Sodic Spot

-  Spoil Area
-  Stony Spot
-  Very Stony Spot
-  Wet Spot
-  Other
-  Special Line Features

Water Features

 Streams and Canals

Transportation

-  Rails
-  Interstate Highways
-  US Routes
-  Major Roads
-  Local Roads

Background

 Aerial Photography

MAP INFORMATION

The soil surveys that comprise your AOI were mapped at 1:24,000.

Warning: Soil Map may not be valid at this scale.

Enlargement of maps beyond the scale of mapping can cause misunderstanding of the detail of mapping and accuracy of soil line placement. The maps do not show the small areas of contrasting soils that could have been shown at a more detailed scale.

Please rely on the bar scale on each map sheet for map measurements.

Source of Map: Natural Resources Conservation Service
 Web Soil Survey URL:
 Coordinate System: Web Mercator (EPSG:3857)

Maps from the Web Soil Survey are based on the Web Mercator projection, which preserves direction and shape but distorts distance and area. A projection that preserves area, such as the Albers equal-area conic projection, should be used if more accurate calculations of distance or area are required.

This product is generated from the USDA-NRCS certified data as of the version date(s) listed below.

Soil Survey Area: Jackson County, Missouri
 Survey Area Data: Version 18, Sep 16, 2017

Soil map units are labeled (as space allows) for map scales 1:50,000 or larger.

Date(s) aerial images were photographed: Oct 14, 2014—Oct 10, 2016

The orthophoto or other base map on which the soil lines were compiled and digitized probably differs from the background imagery displayed on these maps. As a result, some minor shifting of map unit boundaries may be evident.

Map Unit Legend

Map Unit Symbol	Map Unit Name	Acres in AOI	Percent of AOI
10082	Arisburg-Urban land complex, 1 to 5 percent slopes	3.8	45.1%
10180	Udarents-Urban land-Sampsel complex, 2 to 5 percent slopes	4.6	54.9%
Totals for Area of Interest		8.3	100.0%

Map Unit Descriptions

The map units delineated on the detailed soil maps in a soil survey represent the soils or miscellaneous areas in the survey area. The map unit descriptions, along with the maps, can be used to determine the composition and properties of a unit.

A map unit delineation on a soil map represents an area dominated by one or more major kinds of soil or miscellaneous areas. A map unit is identified and named according to the taxonomic classification of the dominant soils. Within a taxonomic class there are precisely defined limits for the properties of the soils. On the landscape, however, the soils are natural phenomena, and they have the characteristic variability of all natural phenomena. Thus, the range of some observed properties may extend beyond the limits defined for a taxonomic class. Areas of soils of a single taxonomic class rarely, if ever, can be mapped without including areas of other taxonomic classes. Consequently, every map unit is made up of the soils or miscellaneous areas for which it is named and some minor components that belong to taxonomic classes other than those of the major soils.

Most minor soils have properties similar to those of the dominant soil or soils in the map unit, and thus they do not affect use and management. These are called noncontrasting, or similar, components. They may or may not be mentioned in a particular map unit description. Other minor components, however, have properties and behavioral characteristics divergent enough to affect use or to require different management. These are called contrasting, or dissimilar, components. They generally are in small areas and could not be mapped separately because of the scale used. Some small areas of strongly contrasting soils or miscellaneous areas are identified by a special symbol on the maps. If included in the database for a given area, the contrasting minor components are identified in the map unit descriptions along with some characteristics of each. A few areas of minor components may not have been observed, and consequently they are not mentioned in the descriptions, especially where the pattern was so complex that it was impractical to make enough observations to identify all the soils and miscellaneous areas on the landscape.

The presence of minor components in a map unit in no way diminishes the usefulness or accuracy of the data. The objective of mapping is not to delineate pure taxonomic classes but rather to separate the landscape into landforms or landform segments that have similar use and management requirements. The delineation of such segments on the map provides sufficient information for the

Custom Soil Resource Report

development of resource plans. If intensive use of small areas is planned, however, onsite investigation is needed to define and locate the soils and miscellaneous areas.

An identifying symbol precedes the map unit name in the map unit descriptions. Each description includes general facts about the unit and gives important soil properties and qualities.

Soils that have profiles that are almost alike make up a *soil series*. Except for differences in texture of the surface layer, all the soils of a series have major horizons that are similar in composition, thickness, and arrangement.

Soils of one series can differ in texture of the surface layer, slope, stoniness, salinity, degree of erosion, and other characteristics that affect their use. On the basis of such differences, a soil series is divided into *soil phases*. Most of the areas shown on the detailed soil maps are phases of soil series. The name of a soil phase commonly indicates a feature that affects use or management. For example, Alpha silt loam, 0 to 2 percent slopes, is a phase of the Alpha series.

Some map units are made up of two or more major soils or miscellaneous areas. These map units are complexes, associations, or undifferentiated groups.

A *complex* consists of two or more soils or miscellaneous areas in such an intricate pattern or in such small areas that they cannot be shown separately on the maps. The pattern and proportion of the soils or miscellaneous areas are somewhat similar in all areas. Alpha-Beta complex, 0 to 6 percent slopes, is an example.

An *association* is made up of two or more geographically associated soils or miscellaneous areas that are shown as one unit on the maps. Because of present or anticipated uses of the map units in the survey area, it was not considered practical or necessary to map the soils or miscellaneous areas separately. The pattern and relative proportion of the soils or miscellaneous areas are somewhat similar. Alpha-Beta association, 0 to 2 percent slopes, is an example.

An *undifferentiated group* is made up of two or more soils or miscellaneous areas that could be mapped individually but are mapped as one unit because similar interpretations can be made for use and management. The pattern and proportion of the soils or miscellaneous areas in a mapped area are not uniform. An area can be made up of only one of the major soils or miscellaneous areas, or it can be made up of all of them. Alpha and Beta soils, 0 to 2 percent slopes, is an example.

Some surveys include *miscellaneous areas*. Such areas have little or no soil material and support little or no vegetation. Rock outcrop is an example.

Jackson County, Missouri

10082—Arisburg-Urban land complex, 1 to 5 percent slopes

Map Unit Setting

National map unit symbol: 2w7ld
Elevation: 750 to 1,130 feet
Mean annual precipitation: 39 to 45 inches
Mean annual air temperature: 50 to 55 degrees F
Frost-free period: 177 to 220 days
Farmland classification: All areas are prime farmland

Map Unit Composition

Arisburg and similar soils: 61 percent
Urban land: 30 percent
Minor components: 9 percent
Estimates are based on observations, descriptions, and transects of the mapunit.

Description of Arisburg

Setting

Landform: Interfluves
Landform position (two-dimensional): Summit
Landform position (three-dimensional): Interfluve
Down-slope shape: Convex
Across-slope shape: Convex
Parent material: Loess

Typical profile

Ap - 0 to 6 inches: silt loam
A - 6 to 13 inches: silt loam
Bt - 13 to 19 inches: silty clay loam
Btg - 19 to 56 inches: silty clay loam
BCg - 56 to 79 inches: silty clay loam

Properties and qualities

Slope: 1 to 5 percent
Depth to restrictive feature: More than 80 inches
Natural drainage class: Somewhat poorly drained
Capacity of the most limiting layer to transmit water (Ksat): Moderately high (0.20 to 0.60 in/hr)
Depth to water table: About 18 to 30 inches
Frequency of flooding: None
Frequency of ponding: None
Salinity, maximum in profile: Nonsaline to very slightly saline (0.0 to 2.0 mmhos/cm)
Available water storage in profile: High (about 11.5 inches)

Interpretive groups

Land capability classification (irrigated): None specified
Land capability classification (nonirrigated): 2e
Hydrologic Soil Group: C
Ecological site: Loess Upland Prairie (R107BY007MO)
Hydric soil rating: No

Description of Urban Land

Interpretive groups

Land capability classification (irrigated): None specified
Land capability classification (nonirrigated): 8
Hydric soil rating: No

Minor Components

Sharpsburg

Percent of map unit: 3 percent
Landform: Ridges
Landform position (two-dimensional): Summit
Landform position (three-dimensional): Interfluve
Down-slope shape: Linear
Across-slope shape: Linear
Ecological site: Loess Upland Prairie (R109XY002MO)
Hydric soil rating: No

Sampsel

Percent of map unit: 3 percent
Landform: Hills
Landform position (two-dimensional): Backslope
Landform position (three-dimensional): Side slope
Down-slope shape: Convex
Across-slope shape: Concave
Ecological site: Interbedded Sedimentary Upland Savanna (R109XY010MO)
Hydric soil rating: Yes

Greenton

Percent of map unit: 3 percent
Landform: Hillslopes
Landform position (two-dimensional): Shoulder
Landform position (three-dimensional): Side slope
Down-slope shape: Convex
Across-slope shape: Convex
Ecological site: Loess Upland Prairie (R109XY002MO)
Hydric soil rating: No

10180—Udarents-Urban land-Sampsel complex, 2 to 5 percent slopes

Map Unit Setting

National map unit symbol: 1n85h
Elevation: 600 to 900 feet
Mean annual precipitation: 33 to 43 inches
Mean annual air temperature: 50 to 57 degrees F
Frost-free period: 175 to 220 days
Farmland classification: All areas are prime farmland

Map Unit Composition

Udarents and similar soils: 41 percent

Urban land: 39 percent

Sampsel and similar soils: 15 percent

Estimates are based on observations, descriptions, and transects of the mapunit.

Description of Udarents

Setting

Landform position (two-dimensional): Summit

Landform position (three-dimensional): Crest

Down-slope shape: Convex

Across-slope shape: Convex

Parent material: Mine spoil or earthy fill

Typical profile

C1 - 0 to 5 inches: silt loam

C2 - 5 to 80 inches: silty clay loam

Properties and qualities

Slope: 2 to 5 percent

Depth to restrictive feature: More than 80 inches

Natural drainage class: Somewhat poorly drained

Runoff class: Very high

Capacity of the most limiting layer to transmit water (Ksat): Moderately low to moderately high (0.14 to 0.57 in/hr)

Depth to water table: More than 80 inches

Frequency of flooding: None

Frequency of ponding: None

Salinity, maximum in profile: Nonsaline to very slightly saline (0.0 to 2.0 mmhos/cm)

Available water storage in profile: Moderate (about 9.0 inches)

Interpretive groups

Land capability classification (irrigated): None specified

Land capability classification (nonirrigated): 6e

Hydrologic Soil Group: C

Ecological site: Deep Loess Upland Prairie (R107BY002MO)

Other vegetative classification: Mixed/Transitional (Mixed Native Vegetation)

Hydric soil rating: No

Description of Urban Land

Setting

Landform: Interfluves

Landform position (two-dimensional): Summit

Landform position (three-dimensional): Interfluve

Across-slope shape: Convex

Interpretive groups

Land capability classification (irrigated): None specified

Land capability classification (nonirrigated): 8

Hydric soil rating: No

Description of Sampsel

Setting

Landform: Hillslopes
Landform position (two-dimensional): Footslope
Landform position (three-dimensional): Base slope
Down-slope shape: Concave
Across-slope shape: Convex
Parent material: Residuum weathered from shale

Typical profile

Ap - 0 to 13 inches: silty clay loam
Bt - 13 to 80 inches: silty clay

Properties and qualities

Slope: 2 to 5 percent
Depth to restrictive feature: More than 80 inches
Natural drainage class: Somewhat poorly drained
Runoff class: Very high
Capacity of the most limiting layer to transmit water (Ksat): Moderately low to moderately high (0.06 to 0.20 in/hr)
Depth to water table: About 0 to 18 inches
Frequency of flooding: None
Frequency of ponding: None
Salinity, maximum in profile: Nonsaline to very slightly saline (0.0 to 2.0 mmhos/cm)
Available water storage in profile: Moderate (about 8.6 inches)

Interpretive groups

Land capability classification (irrigated): None specified
Land capability classification (nonirrigated): 2e
Hydrologic Soil Group: C/D
Ecological site: Wet Footslope Prairie (R112XY041MO)
Other vegetative classification: Grass/Prairie (Herbaceous Vegetation)
Hydric soil rating: No

References

- American Association of State Highway and Transportation Officials (AASHTO). 2004. Standard specifications for transportation materials and methods of sampling and testing. 24th edition.
- American Society for Testing and Materials (ASTM). 2005. Standard classification of soils for engineering purposes. ASTM Standard D2487-00.
- Cowardin, L.M., V. Carter, F.C. Golet, and E.T. LaRoe. 1979. Classification of wetlands and deep-water habitats of the United States. U.S. Fish and Wildlife Service FWS/OBS-79/31.
- Federal Register. July 13, 1994. Changes in hydric soils of the United States.
- Federal Register. September 18, 2002. Hydric soils of the United States.
- Hurt, G.W., and L.M. Vasilas, editors. Version 6.0, 2006. Field indicators of hydric soils in the United States.
- National Research Council. 1995. Wetlands: Characteristics and boundaries.
- Soil Survey Division Staff. 1993. Soil survey manual. Soil Conservation Service. U.S. Department of Agriculture Handbook 18. http://www.nrcs.usda.gov/wps/portal/nrcs/detail/national/soils/?cid=nrcs142p2_054262
- Soil Survey Staff. 1999. Soil taxonomy: A basic system of soil classification for making and interpreting soil surveys. 2nd edition. Natural Resources Conservation Service, U.S. Department of Agriculture Handbook 436. http://www.nrcs.usda.gov/wps/portal/nrcs/detail/national/soils/?cid=nrcs142p2_053577
- Soil Survey Staff. 2010. Keys to soil taxonomy. 11th edition. U.S. Department of Agriculture, Natural Resources Conservation Service. http://www.nrcs.usda.gov/wps/portal/nrcs/detail/national/soils/?cid=nrcs142p2_053580
- Tiner, R.W., Jr. 1985. Wetlands of Delaware. U.S. Fish and Wildlife Service and Delaware Department of Natural Resources and Environmental Control, Wetlands Section.
- United States Army Corps of Engineers, Environmental Laboratory. 1987. Corps of Engineers wetlands delineation manual. Waterways Experiment Station Technical Report Y-87-1.
- United States Department of Agriculture, Natural Resources Conservation Service. National forestry manual. http://www.nrcs.usda.gov/wps/portal/nrcs/detail/soils/home/?cid=nrcs142p2_053374
- United States Department of Agriculture, Natural Resources Conservation Service. National range and pasture handbook. <http://www.nrcs.usda.gov/wps/portal/nrcs/detail/national/landuse/rangepasture/?cid=stelprdb1043084>

Custom Soil Resource Report

United States Department of Agriculture, Natural Resources Conservation Service. National soil survey handbook, title 430-VI. http://www.nrcs.usda.gov/wps/portal/nrcs/detail/soils/scientists/?cid=nrcs142p2_054242

United States Department of Agriculture, Natural Resources Conservation Service. 2006. Land resource regions and major land resource areas of the United States, the Caribbean, and the Pacific Basin. U.S. Department of Agriculture Handbook 296. http://www.nrcs.usda.gov/wps/portal/nrcs/detail/national/soils/?cid=nrcs142p2_053624

United States Department of Agriculture, Soil Conservation Service. 1961. Land capability classification. U.S. Department of Agriculture Handbook 210. http://www.nrcs.usda.gov/Internet/FSE_DOCUMENTS/nrcs142p2_052290.pdf

Exhibit C

Composite Curve Number Calculations

Composite Curve Numbers

Existing Conditions

Sub-basin A	Area (ac.)	CN	Area x CN
Gravel Area	0.43	89	38.27
Impervious Area	0.28	98	27.44
Pervious Area	7.58	74	560.92
Offsite Gravel	2.76	89	245.64
Offsite Impervious	1.01	98	98.98
Offsite Pervious	7.11	74	526.14
Total Area	19.17		1497.39
Composite CN		78	

Proposed Conditions

Sub-basin A	Area (ac.)	CN	Area x CN
Gravel Area	0.22	89	19.58
Impervious Area	0.98	98	96.04
Pervious Area	7.09	74	524.66
Offsite Gravel	2.76	89	245.64
Offsite Impervious	1.01	98	98.98
Offsite Pervious	7.11	74	526.14
Total Area	19.17		1511.04
Composite CN		79	

Future Conditions

Sub-basin A	Area (ac.)	CN	Area x CN
Commercial Area	7.59	94	713.46
Pervious Area	0.70	74	51.80
Offsite Gravel	2.76	89	245.64
Offsite Impervious	1.01	98	98.98
Offsite Pervious	7.11	74	526.14
Total Area	19.17		1636.02
Composite CN		85	

Future Conditions (Split)

Sub-basin A (north)	Area (ac.)	CN	Area x CN
Pervious North	0.12	74	9.12
Commercial Area (South)	1.92	94	180.62
Commercial Area (North)	1.65	94	154.76
Pervious South	0.06	74	4.10
North Offsite	5.14	81	416.34
South Offsite	1.23	79	97.45
Total Area	10.12		862.39
Composite CN		85	

Sub-basin A1 (South)

	Area (ac.)	CN	Area x CN
Commercial Area (South)	1.58	94	148.76
Commercial Area (North)	2.44	94	229.32
Pervious Detention	0.52	74	38.58
Total Area	4.52	79	356.80
Composite CN		85	

Exhibit D

Time of Concentration Calculations

APWA STORM DRAINAGE "TC" COMPUTATIONS FOR : 1600 HAMBLEN ROAD

AREA ID	TOTAL WATERSHED				SURFACE TYPES: Asph/Conc Bus/Com Dirt Grass/Park Lake MultFam SnglFam Undev Other										TC COMPUTATION					Intensity		AREA ID		
	TOTAL ACRES	WTRSHD LENGTH	UP ELEV	DN ELEV	SURFACE CODE	"C" VALUE	OVRLND LENGTH	UP ELEV	DN ELEV	SLOPE %	SURFACE CODE	CHANNEL LENGTH	UP ELEV	DN ELEV	SLOPE %	VELOCITY F/S	Cal Flow T(I)	Used Min 5 Max 15 T(I)	Cal Channel One T(T)	Cal Channel Two T(T)	Total T@ 10		10 I	100 I
EX. EX.	5.14	1646.2	1040.5	1006.2	Z	0.43	100.0	1040.5	1038.5	2.0	U	765.3	1038.5	1026.0	1.63	2.1	9.6	9.6	6.2	5.1	20.9	4.7	6.5	EX. EX.
PROP. PROP.	5.14	CHANNEL (2)			Z	0.43	100.0	1040.5	1038.5	2.0	U	780.9	1026.0	1006.2	2.54	2.6	0.0	0.0	5.1	0.0	5.1	7.3	10.3	PROP. PROP.
FUT. A FUT. A	5.14	1646.2	1040.5	1006.2	Z	0.43	100.0	1040.5	1038.5	2.0	U	765.3	1038.5	1026.0	1.63	2.1	9.6	9.6	6.2	5.1	20.9	4.7	6.5	FUT. A FUT. A
FUT. A1	5.14	CHANNEL (2)			P	0.43	100.0	1026.0	1006.2	2.54	3.2	780.9	1026.0	1006.2	2.54	3.2	0.0	0.0	4.0	0.0	4.0	7.7	10.7	FUT. A1
FUT. A1	5.75	1332.4	1035.3	1006.2	Z	0.43	100.0	1035.3	1033.8	1.5	U	1232.4	1033.8	1006.2	2.24	2.4	10.5	10.5	8.5	0.0	19.0	4.6	6.7	FUT. A1

* Velocity = 16.1345 x SQRT(slope) [Unpaved] Velocity = 20.3282 x SQRT(slope) [Paved] Formula taken from "Urban Hydrology for Small Watersheds - Technical Release 55", Appendix F, Figure 3-1.

** T(I) = 1.8 x (1.1-C) x SQRT(overland length) / (slope)^1/3 Formula taken from American Public Works Association 5602.5.

*** T(T) = Channel Length / Velocity Formula taken from "Urban Hydrology for Small Watersheds - Technical Release 55", Eq. 3-1.

Exhibit E

Existing Conditions Land Usage Map

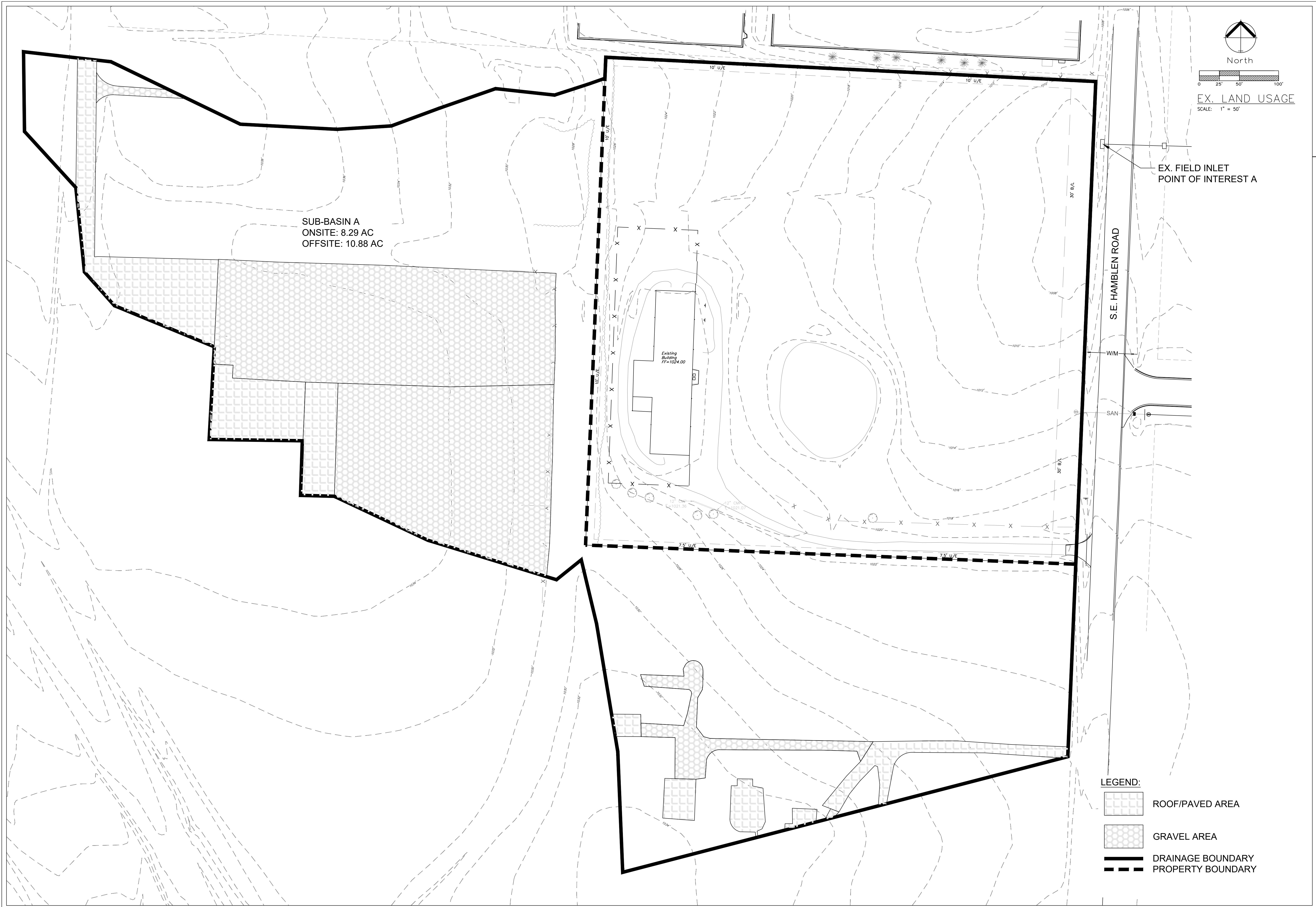

SUB-BASIN A
 ONSITE: 8.29 AC
 OFFSITE: 10.88 AC

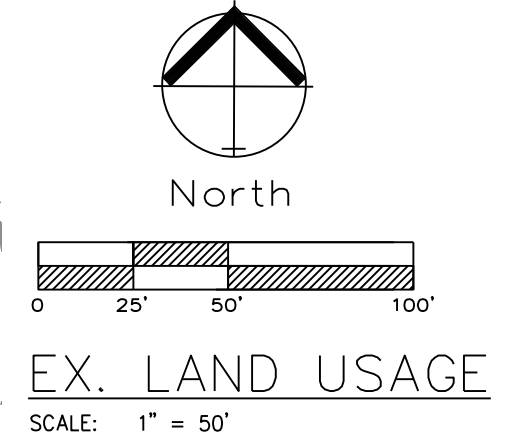

EX. FIELD INLET
 POINT OF INTEREST A

S.E. HAMBLEN ROAD

W/M

SAN





- LEGEND:**
-  ROOF/PAVED AREA
 -  GRAVEL AREA
 -  DRAINAGE BOUNDARY
 -  PROPERTY BOUNDARY

Exhibit F

Existing Conditions Drainage Map



SUB-BASIN A
 ONSITE: 8.29 AC
 OFFSITE: 10.88 AC

EX. FIELD INLET
 POINT OF INTEREST A





S.E. HAMBLEN ROAD



0 25' 50' 100'

EX. DRAINAGE MAP
 SCALE: 1" = 50'

LEGEND:

-  ROOF/PAVED AREA
-  GRAVEL AREA
-  DRAINAGE BOUNDARY
-  PROPERTY BOUNDARY

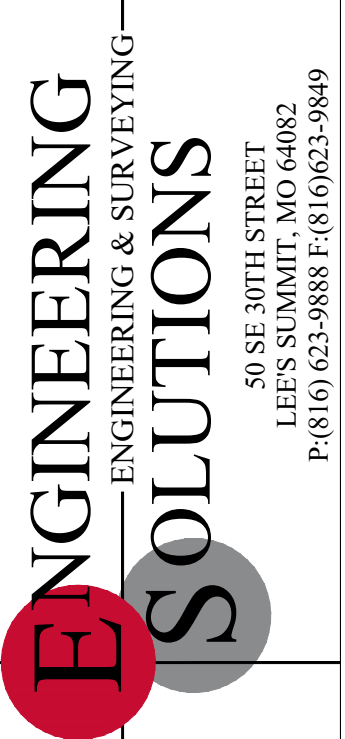

Professional Registration
 Missouri
 Engineering 2005002186-D
 Surveying 2005008319-D
 Kansas
 Engineering E-1695
 Surveying LS-218
 Oklahoma
 Engineering 6254
 Nebraska
 Engineering CA2821

1600 SE HAMBLEN ROAD
 LEE'S SUMMIT, JACKSON COUNTY, MISSOURI

Project: 1600 Hamblen
 Issue Date: July 21, 2017

Exhibit: Existing Drainage Map
 Lot 2, Williams' Crossing
 Lee's Summit, Jackson County, Missouri

Matthew J. Schlicht
 MO PE 2006019708
 KS PE 19071
 OK PE 25226
 NE PE E-14335

REVISIONS
 REV 6-1-18

EXHIBIT

Exhibit G

Proposed Conditions Land Usage Map



SUB-BASIN A
 ONSITE: 8.29 AC
 OFFSITE: 10.88 AC

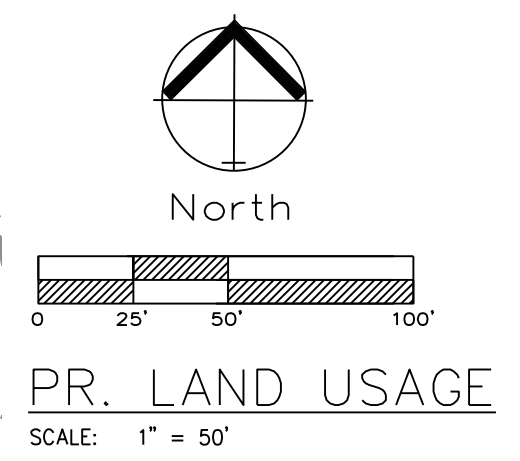

EX. FIELD INLET
 POINT OF INTEREST A

S. E. HAMBLEN ROAD

W/M

SAN

LEGEND:



-  ROOF/PAVED AREA
-  GRAVEL AREA
-  DRAINAGE BOUNDARY
-  PROPERTY BOUNDARY

Exhibit H

Proposed Conditions Drainage Area Map

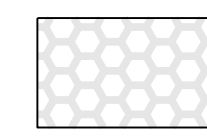

SUB-BASIN A
 ONSITE: 8.29 AC
 OFFSITE: 10.88 AC

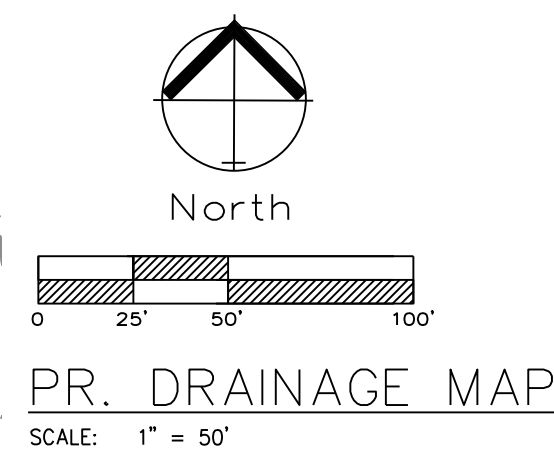

EX. FIELD INLET
 POINT OF INTEREST A

S. E. HAMBLEN ROAD

W/M

SAN





- LEGEND:**
-  ROOF/PAVED AREA
 -  GRAVEL AREA
 -  DRAINAGE BOUNDARY
 -  PROPERTY BOUNDARY

Exhibit I

Future Conditions Drainage Area Map



SUB-BASIN A
 ONSITE: 3.75 AC
 OFFSITE: 6.36 AC

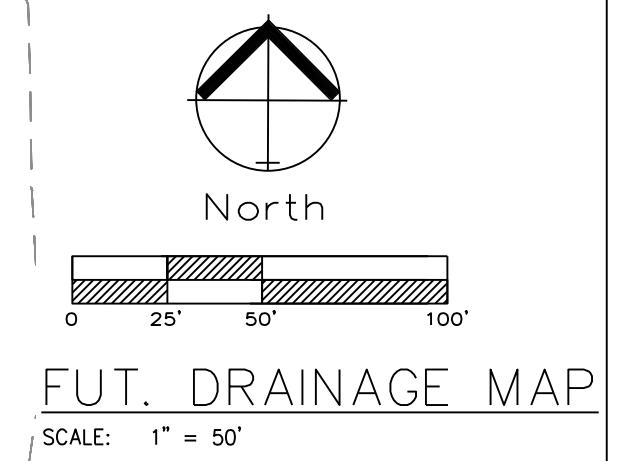
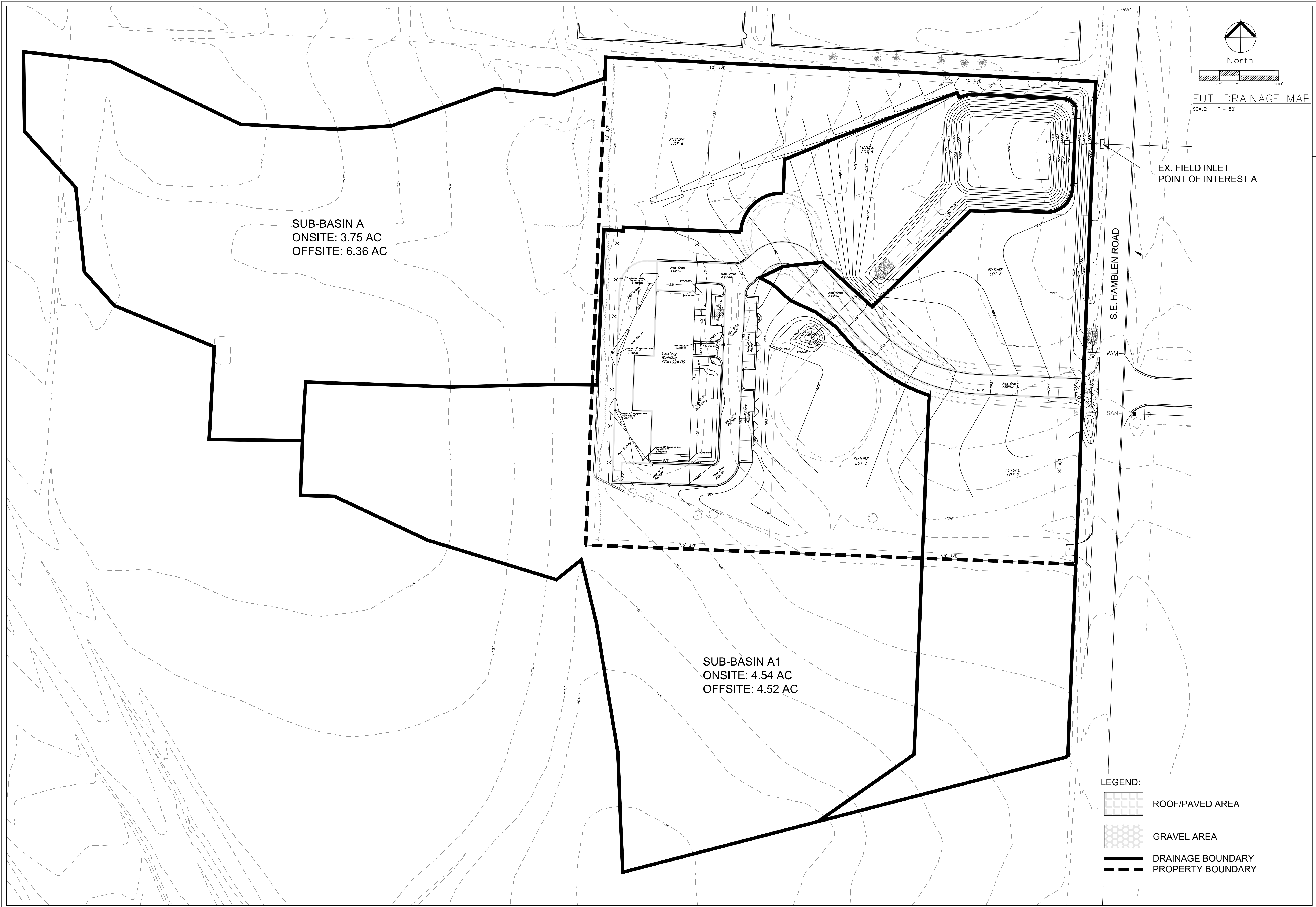



SUB-BASIN A1
 ONSITE: 4.54 AC
 OFFSITE: 4.52 AC

EX. FIELD INLET
 POINT OF INTEREST A

S. E. HAMBLEN ROAD

W/M

SAN

- LEGEND:**
-  ROOF/PAVED AREA
 -  GRAVEL AREA
 -  DRAINAGE BOUNDARY
 -  PROPERTY BOUNDARY

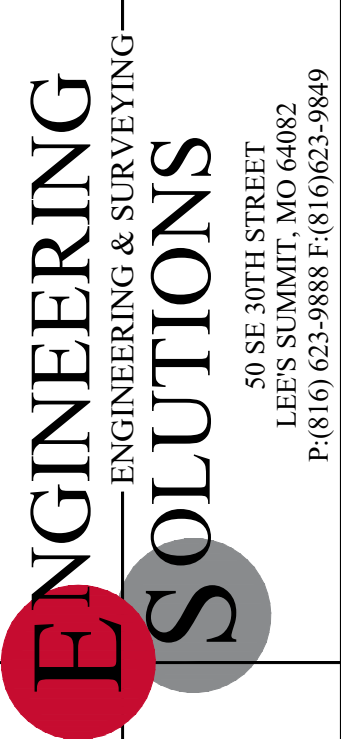

Professional Registration
 Missouri
 Engineering 2005002186-D
 Surveying 2005008319-D
 Kansas
 Engineering E-1695
 Surveying LS-218
 Oklahoma
 Engineering 6254
 Nebraska
 Engineering CA2821

1600 SE HAMBLEN ROAD
 LEE'S SUMMIT, JACKSON COUNTY, MISSOURI

Project:
 1600 Hamblen
 Issue Date:
 July 21, 2017

Exhibit: Future Drainage Map
 Lot 2, Williams' Crossing
 Lee's Summit, Jackson County, Missouri

Matthew J. Schlicht
 MO PE 2006019708
 KS PE 19071
 OK PE 25226
 NE PE E-143325

REVISIONS
 REV 6-1-18

EXHIBIT

Exhibit J

Water Quality Event - 40 Hour Release Calculations

Calculate Water Quality for Storm Study

Project: Tailormade
To Calculate: $WQ_v = P * R_v * A$

7/24/2018

P (in) =	1.37
P (ft) =	0.11
Impervious Area (sq. ft.) =	270,834.30
Total Area (sq. ft.) =	361,112.40
Impervious Area (ac) =	6.22
Total Area (acre) =	8.29
Rv = (0.05 * 0.009(I)) =	0.73
Percent Impervious (I) =	75.00
WQ _v (cu. ft.) =	29,889.57
WQ _v (ac. ft.) =	0.686

LEGEND:

Enter data in these Fields

Values of Interest

Unit Conversions:

1 Acre = 43,560 Sq. Ft.

Pond Provides

Required (Cu. Ft.) = 29,889.57

Pond Volume

Elevation	Area (Sq. Ft.)	Volume (Cu. Ft.)
1,003.20	0	0
1,004.00	3348	1,674.00
1,005.00	8,924.00	6,136.00
1,006.00	10,668.00	15,932.00
1,007.00	11,892.00	27,212.00
1,008.00	13,173.00	39,744.50
1,009.00	15,167.00	53,914.50
1,010.00	17,649.00	70,322.50
1,011.00	20,457.00	89,375.50
1,012.00	23,070.00	111,139.00
1,013.00	25,693.00	135,520.50
1,013.50	35,624.00	166,179.00

40 HOUR DETENTION CALC.

To Calculate:

40 Hour Detention (EDDB)

I. Basin Water Quality Storage Volume

Step 1) Tributary area To EDDB, A_t (ac) =

A_t (ac) = 8.29

Step 2) Calculate WQ_v using Sec. 6 (ac-ft) =

WQ_v (ac. ft.) = 0.686

Step 3) Add 20 Percent to Step 2.

V_{design} (ac-ft) = 0.823

II.a. Water Quality Outlet Type

Step 1) Set water quality outlet type

Type 1 = single orifice

Type 2 = perforated riser or plate

Type 3 = v-notch weir

Engineer's

Recommended

Outlet Type = 1

Step 2) Proceed to Step Iib, Iic, or Iid based on selection

Iib. Water Quality Outlet, Single Orifice

Step 1) Depth of water quality volume at outlet

Z_{wq} (ft) = 4.11

See Below to Calc. Z_{wq}

Step 2) Average Head of water volume over invert of Orifice

H_{wq} (ft) = 2.06

Step 3) Average Water quality outflow rate

Q_{wq} (cfs) = 0.208

Step 4) Set value of orifice discharge coefficient

CO (unitless) = 0.8

a) 0.66 when thickness of riser/weir plate ≤ orifice dia.

b) 0.80 when thickness of riser/weir plate > orifice dia.

Step 5) Water quality outlet orifice dia.

D_o (in) = 2.03

Use 2.0

Utilize Trash Rack if Dia. < 4"

To Calculate Z_{wQ} (ft) interpolated from the contours above.

Elevation 1 =	1007.00	Storage 1 =	27,212.00	Cu. Ft
Elevation X =		Storage X =	29,889.57	Cu. Ft
Elevation 2 =	1008.00	Storage 2 =	39,774.50	Cu. Ft

		Elevation X =	1007.21
Lowest Elevation of Pond =	1003.10		
Elevation X =	1007.21		
Z_{wQ} (ft) =	4.11		

Exhibit K

Detention Basin Plan

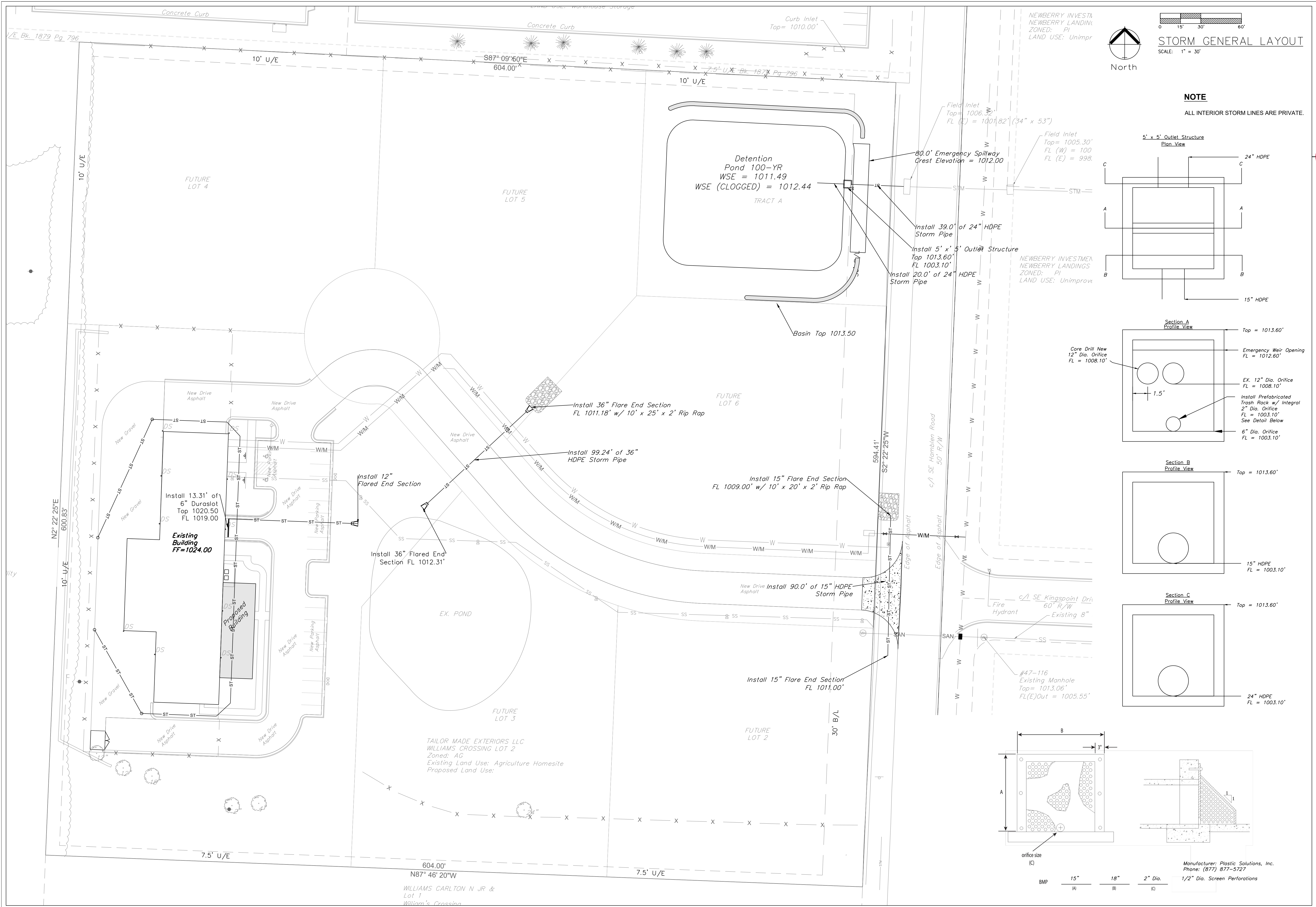

ENGINEERING & SURVEYING SOLUTIONS
50 SE 30TH STREET
LEES SUMMIT, MO 64082
P: (816) 623-9888 F: (816) 623-9849

Professional Registration
Missouri
Engineering 2005002188-D
Surveying 2005008319-D
Kansas
Engineering E-1685
Surveying LS-218
Oklahoma
Engineering 6254
Nebraska
Engineering CA2821

Project:
1600 SE HAMBLEN RD, LEES SUMMIT, MO
August 4, 2017

UTILITY PLAN
Tailormade Landing
1600 Hamblen Road
Lee's Summit, Jackson County, Missouri

C. 300

Exhibit L

Hydraflow Analysis, Emergency Spillway Analysis & Control Structure Inlet Pipe Analysis

Watershed Model Schematic.....	1
Hydrograph Return Period Recap.....	2
2 - Year	
Summary Report.....	3
Hydrograph Reports.....	4
Hydrograph No. 1, SCS Runoff, Existing Sub-basin A.....	4
Hydrograph No. 2, SCS Runoff, Proposed Sub-basin A.....	5
Hydrograph No. 3, SCS Runoff, Future Sub-basin A.....	6
Hydrograph No. 4, SCS Runoff, Future Sub-basin A.....	7
Hydrograph No. 5, SCS Runoff, Future Sub-basin A1.....	8
Hydrograph No. 6, Reservoir, Detention A1.....	9
Pond Report - DETENTION.....	10
Hydrograph No. 7, Combine, POI A.....	11
10 - Year	
Summary Report.....	12
Hydrograph Reports.....	13
Hydrograph No. 1, SCS Runoff, Existing Sub-basin A.....	13
Hydrograph No. 2, SCS Runoff, Proposed Sub-basin A.....	14
Hydrograph No. 3, SCS Runoff, Future Sub-basin A.....	15
Hydrograph No. 4, SCS Runoff, Future Sub-basin A.....	16
Hydrograph No. 5, SCS Runoff, Future Sub-basin A1.....	17
Hydrograph No. 6, Reservoir, Detention A1.....	18
Hydrograph No. 7, Combine, POI A.....	19
100 - Year	
Summary Report.....	20
Hydrograph Reports.....	21
Hydrograph No. 1, SCS Runoff, Existing Sub-basin A.....	21
Hydrograph No. 2, SCS Runoff, Proposed Sub-basin A.....	22
Hydrograph No. 3, SCS Runoff, Future Sub-basin A.....	23
Hydrograph No. 4, SCS Runoff, Future Sub-basin A.....	24
Hydrograph No. 5, SCS Runoff, Future Sub-basin A1.....	25
Hydrograph No. 6, Reservoir, Detention A1.....	26
Hydrograph No. 7, Combine, POI A.....	27
IDF Report.....	28

Watershed Model Schematic

Hydraflow Hydrographs Extension for AutoCAD® Civil 3D® 2018 by Autodesk, Inc. v12

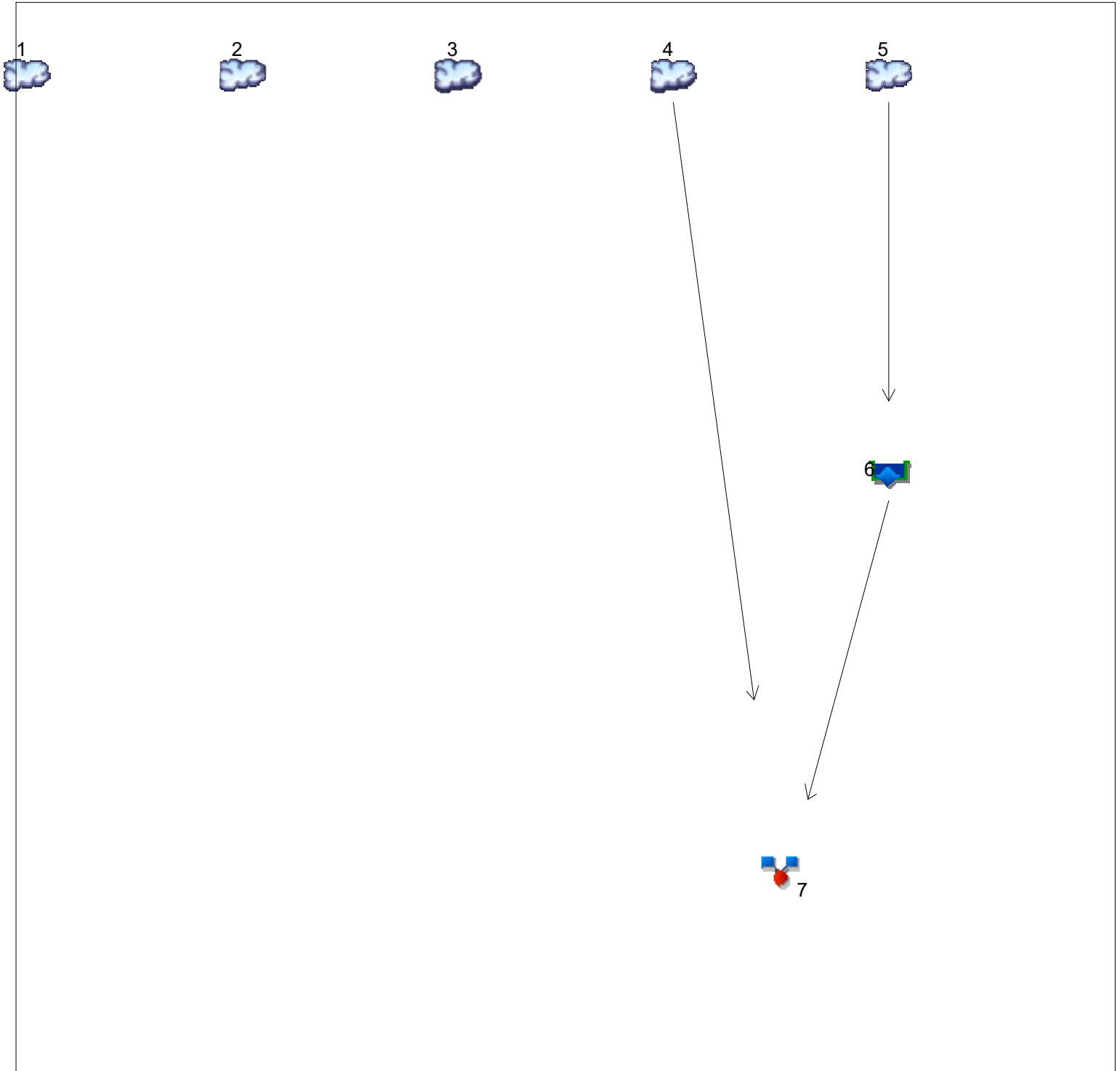

Legend

Hyd.	Origin	Description
1	SCS Runoff	Existing Sub-basin A
2	SCS Runoff	Proposed Sub-basin A
3	SCS Runoff	Future Sub-basin A
4	SCS Runoff	Future Sub-basin A
5	SCS Runoff	Future Sub-basin A1
6	Reservoir	Detention A1
7	Combine	POI A

Hydrograph Return Period Recap

Hydraflow Hydrographs Extension for AutoCAD® Civil 3D® 2018 by Autodesk, Inc. v12

Hyd. No.	Hydrograph type (origin)	Inflow hyd(s)	Peak Outflow (cfs)								Hydrograph Description
			1-yr	2-yr	3-yr	5-yr	10-yr	25-yr	50-yr	100-yr	
1	SCS Runoff	-----	-----	31.54	-----	-----	61.65	-----	-----	108.59	Existing Sub-basin A
2	SCS Runoff	-----	-----	33.14	-----	-----	63.62	-----	-----	110.78	Proposed Sub-basin A
3	SCS Runoff	-----	-----	44.92	-----	-----	78.23	-----	-----	127.64	Future Sub-basin A
4	SCS Runoff	-----	-----	23.71	-----	-----	41.30	-----	-----	67.38	Future Sub-basin A
5	SCS Runoff	-----	-----	22.06	-----	-----	37.87	-----	-----	61.21	Future Sub-basin A1
6	Reservoir	5	-----	0.919	-----	-----	8.011	-----	-----	14.44	Detention A1
7	Combine	4, 6	-----	23.91	-----	-----	41.55	-----	-----	77.80	POI A

Hydrograph Summary Report

Hydraflow Hydrographs Extension for AutoCAD® Civil 3D® 2018 by Autodesk, Inc. v12

Hyd. No.	Hydrograph type (origin)	Peak flow (cfs)	Time interval (min)	Time to Peak (min)	Hyd. volume (cuft)	Inflow hyd(s)	Maximum elevation (ft)	Total strge used (cuft)	Hydrograph Description
1	SCS Runoff	31.54	1	726	105,200	-----	-----	-----	Existing Sub-basin A
2	SCS Runoff	33.14	1	726	110,020	-----	-----	-----	Proposed Sub-basin A
3	SCS Runoff	44.92	1	725	140,314	-----	-----	-----	Future Sub-basin A
4	SCS Runoff	23.71	1	725	74,073	-----	-----	-----	Future Sub-basin A
5	SCS Runoff	22.06	1	725	69,010	-----	-----	-----	Future Sub-basin A1
6	Reservoir	0.919	1	882	45,343	5	1008.36	46,253	Detention A1
7	Combine	23.91	1	725	119,416	4, 6	-----	-----	POI A
7-24-18 HAMBLÉN STUDY.gpw					Return Period: 2 Year			Thursday, 07 / 26 / 2018	

Hydrograph Report

Hyd. No. 1

Existing Sub-basin A

Hydrograph type	= SCS Runoff	Peak discharge	= 31.54 cfs
Storm frequency	= 2 yrs	Time to peak	= 12.10 hrs
Time interval	= 1 min	Hyd. volume	= 105,200 cuft
Drainage area	= 19.170 ac	Curve number	= 78
Basin Slope	= 0.0 %	Hydraulic length	= 0 ft
Tc method	= User	Time of conc. (Tc)	= 20.90 min
Total precip.	= 3.50 in	Distribution	= Type II
Storm duration	= 24 hrs	Shape factor	= 484

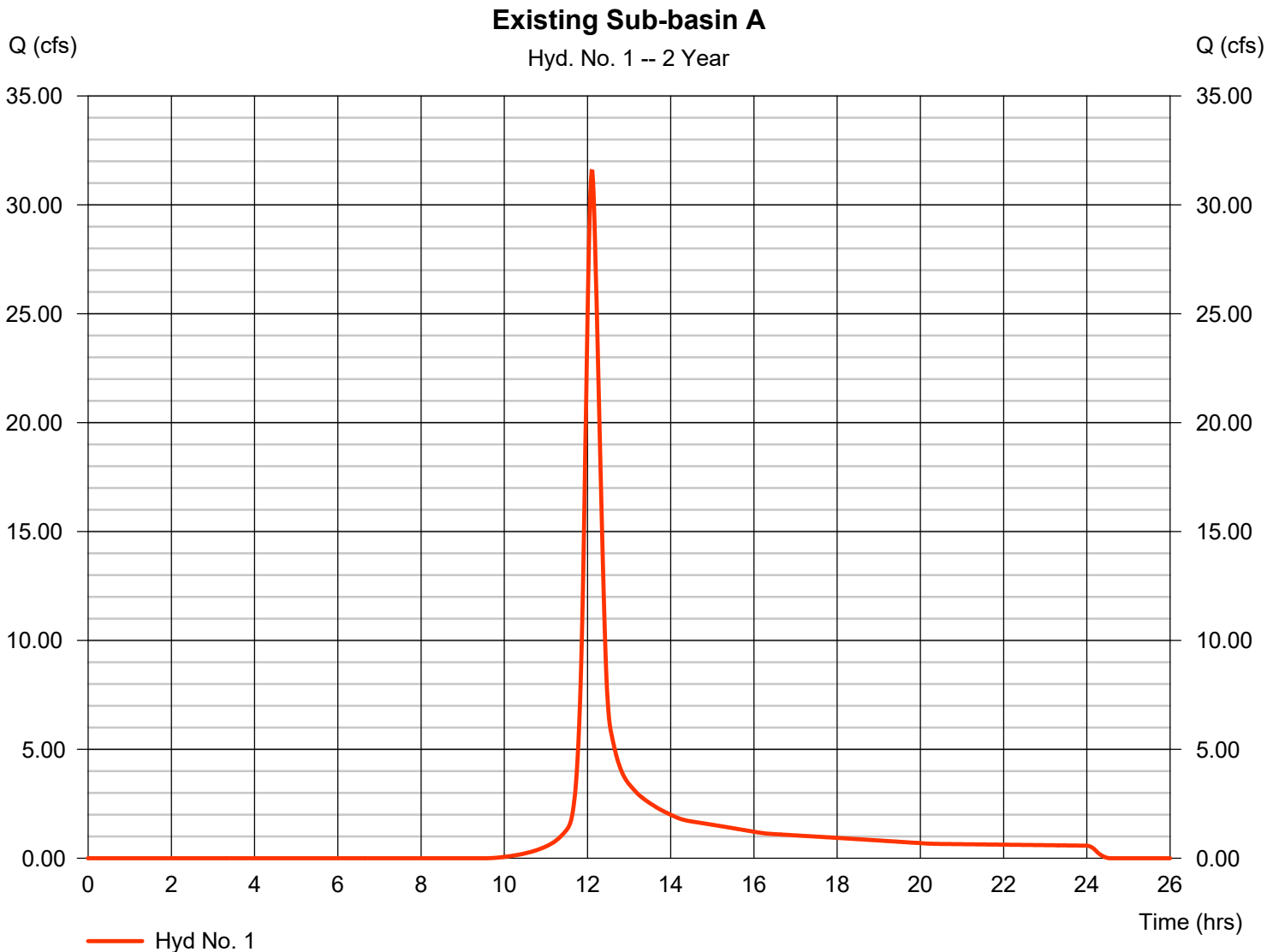

Hydrograph Report

Hydraflow Hydrographs Extension for AutoCAD® Civil 3D® 2018 by Autodesk, Inc. v12

Thursday, 07 / 26 / 2018

Hyd. No. 2

Proposed Sub-basin A

Hydrograph type	= SCS Runoff	Peak discharge	= 33.14 cfs
Storm frequency	= 2 yrs	Time to peak	= 12.10 hrs
Time interval	= 1 min	Hyd. volume	= 110,020 cuft
Drainage area	= 19.170 ac	Curve number	= 79
Basin Slope	= 0.0 %	Hydraulic length	= 0 ft
Tc method	= User	Time of conc. (Tc)	= 20.90 min
Total precip.	= 3.50 in	Distribution	= Type II
Storm duration	= 24 hrs	Shape factor	= 484

Proposed Sub-basin A

Hyd. No. 2 -- 2 Year

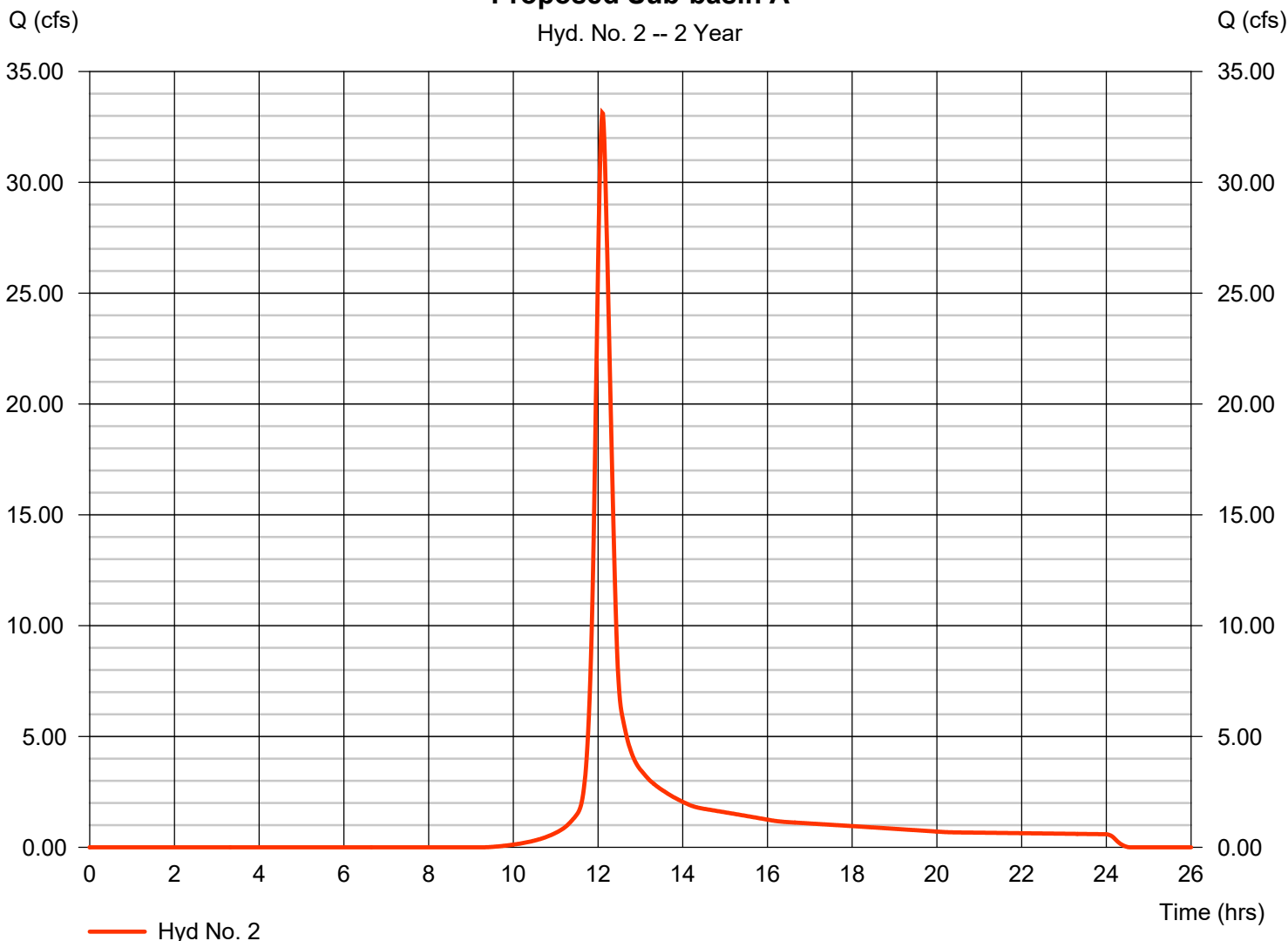

Hydrograph Report

Hydraflow Hydrographs Extension for AutoCAD® Civil 3D® 2018 by Autodesk, Inc. v12

Thursday, 07 / 26 / 2018

Hyd. No. 3

Future Sub-basin A

Hydrograph type	= SCS Runoff	Peak discharge	= 44.92 cfs
Storm frequency	= 2 yrs	Time to peak	= 12.08 hrs
Time interval	= 1 min	Hyd. volume	= 140,314 cuft
Drainage area	= 19.170 ac	Curve number	= 85
Basin Slope	= 0.0 %	Hydraulic length	= 0 ft
Tc method	= User	Time of conc. (Tc)	= 19.80 min
Total precip.	= 3.50 in	Distribution	= Type II
Storm duration	= 24 hrs	Shape factor	= 484

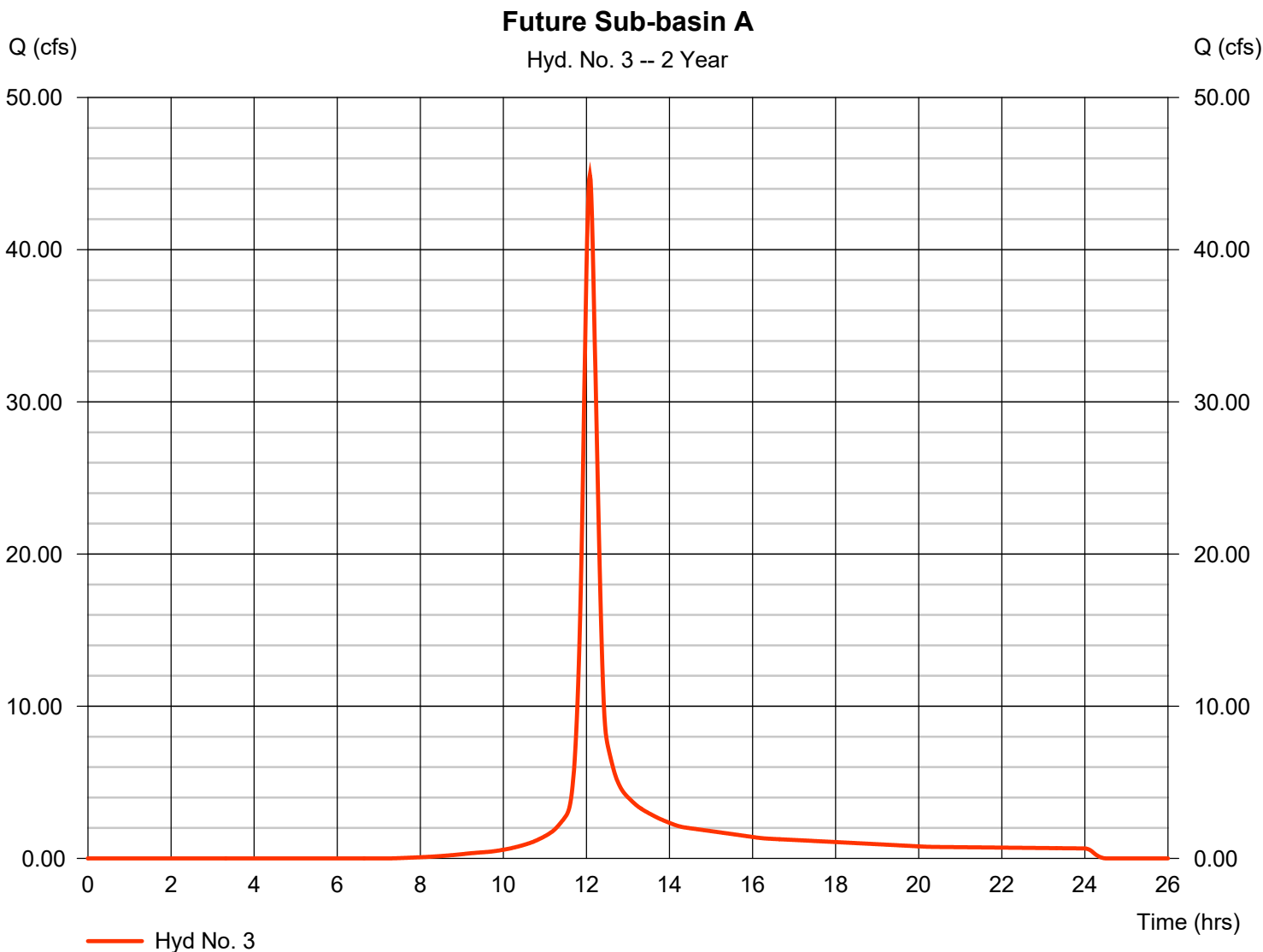

Hydrograph Report

Hydraflow Hydrographs Extension for AutoCAD® Civil 3D® 2018 by Autodesk, Inc. v12

Thursday, 07 / 26 / 2018

Hyd. No. 4

Future Sub-basin A

Hydrograph type	= SCS Runoff	Peak discharge	= 23.71 cfs
Storm frequency	= 2 yrs	Time to peak	= 12.08 hrs
Time interval	= 1 min	Hyd. volume	= 74,073 cuft
Drainage area	= 10.120 ac	Curve number	= 85
Basin Slope	= 0.0 %	Hydraulic length	= 0 ft
Tc method	= User	Time of conc. (Tc)	= 19.80 min
Total precip.	= 3.50 in	Distribution	= Type II
Storm duration	= 24 hrs	Shape factor	= 484

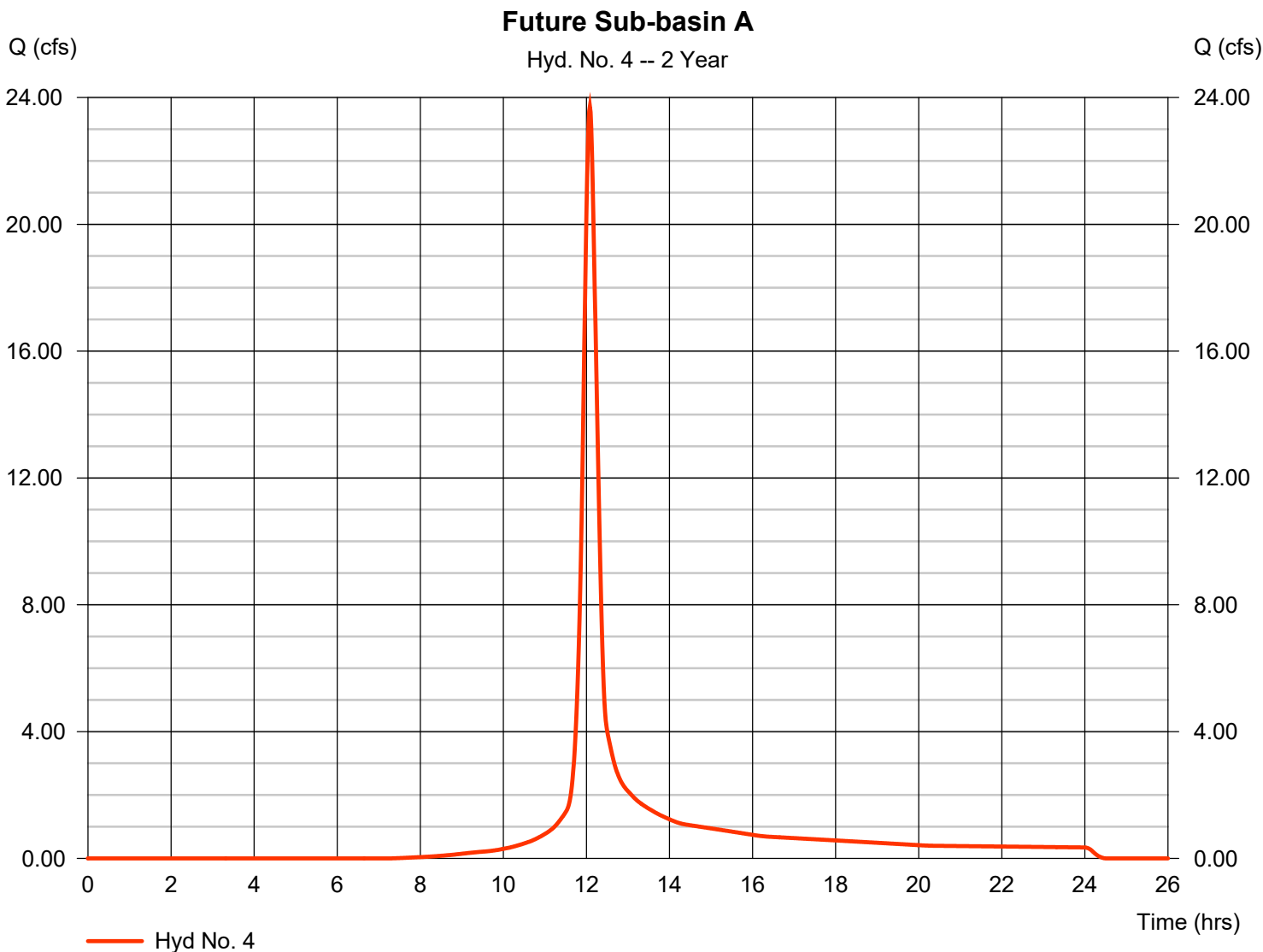

Hydrograph Report

Hydraflow Hydrographs Extension for AutoCAD® Civil 3D® 2018 by Autodesk, Inc. v12

Thursday, 07 / 26 / 2018

Hyd. No. 5

Future Sub-basin A1

Hydrograph type	= SCS Runoff	Peak discharge	= 22.06 cfs
Storm frequency	= 2 yrs	Time to peak	= 12.08 hrs
Time interval	= 1 min	Hyd. volume	= 69,010 cuft
Drainage area	= 9.060 ac	Curve number	= 86
Basin Slope	= 0.0 %	Hydraulic length	= 0 ft
Tc method	= User	Time of conc. (Tc)	= 19.00 min
Total precip.	= 3.50 in	Distribution	= Type II
Storm duration	= 24 hrs	Shape factor	= 484

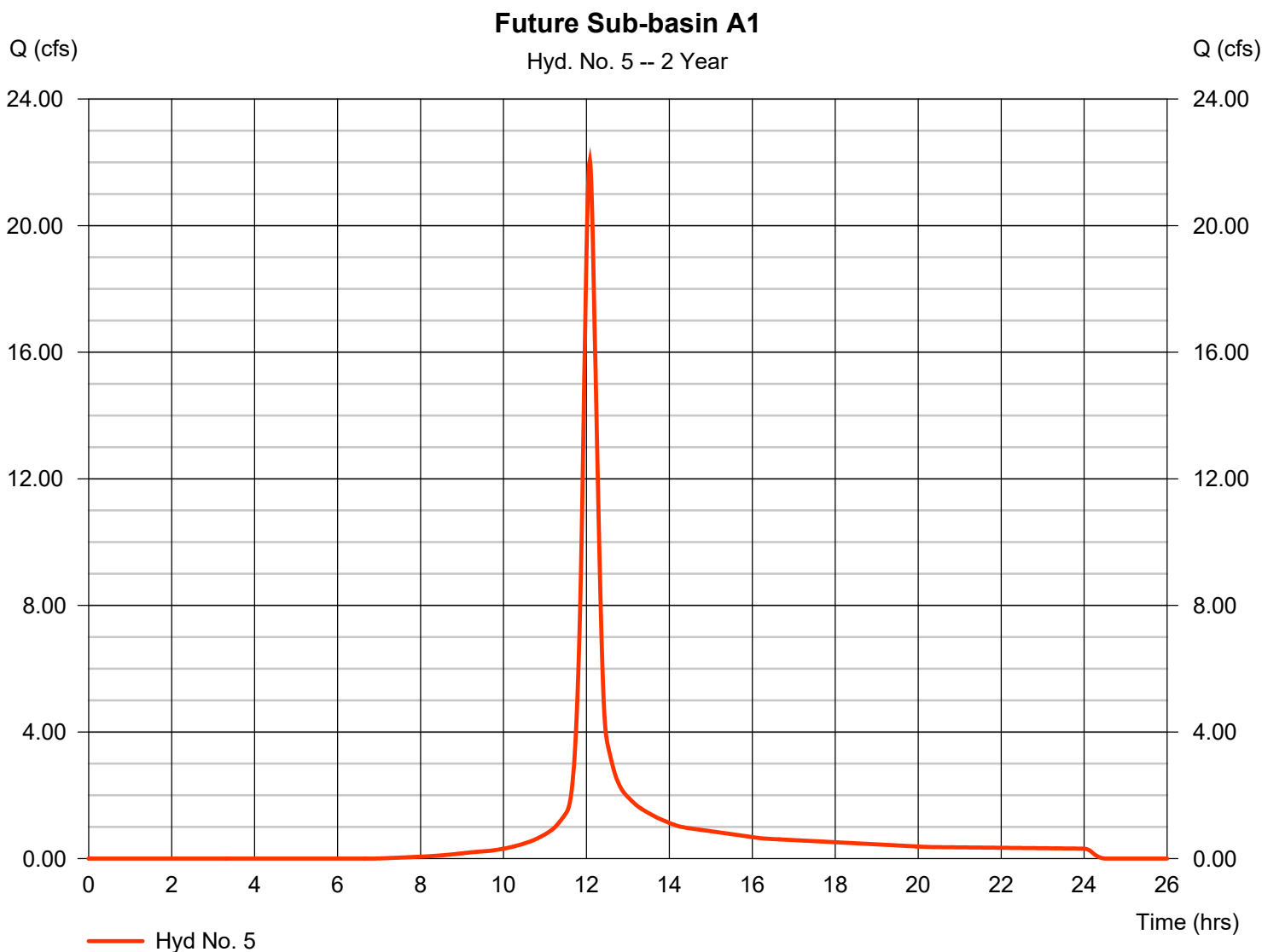

Hydrograph Report

Hydraflow Hydrographs Extension for AutoCAD® Civil 3D® 2018 by Autodesk, Inc. v12

Thursday, 07 / 26 / 2018

Hyd. No. 6

Detention A1

Hydrograph type	= Reservoir	Peak discharge	= 0.919 cfs
Storm frequency	= 2 yrs	Time to peak	= 14.70 hrs
Time interval	= 1 min	Hyd. volume	= 45,343 cuft
Inflow hyd. No.	= 5 - Future Sub-basin A1	Max. Elevation	= 1008.36 ft
Reservoir name	= DETENTION	Max. Storage	= 46,253 cuft

Storage Indication method used.

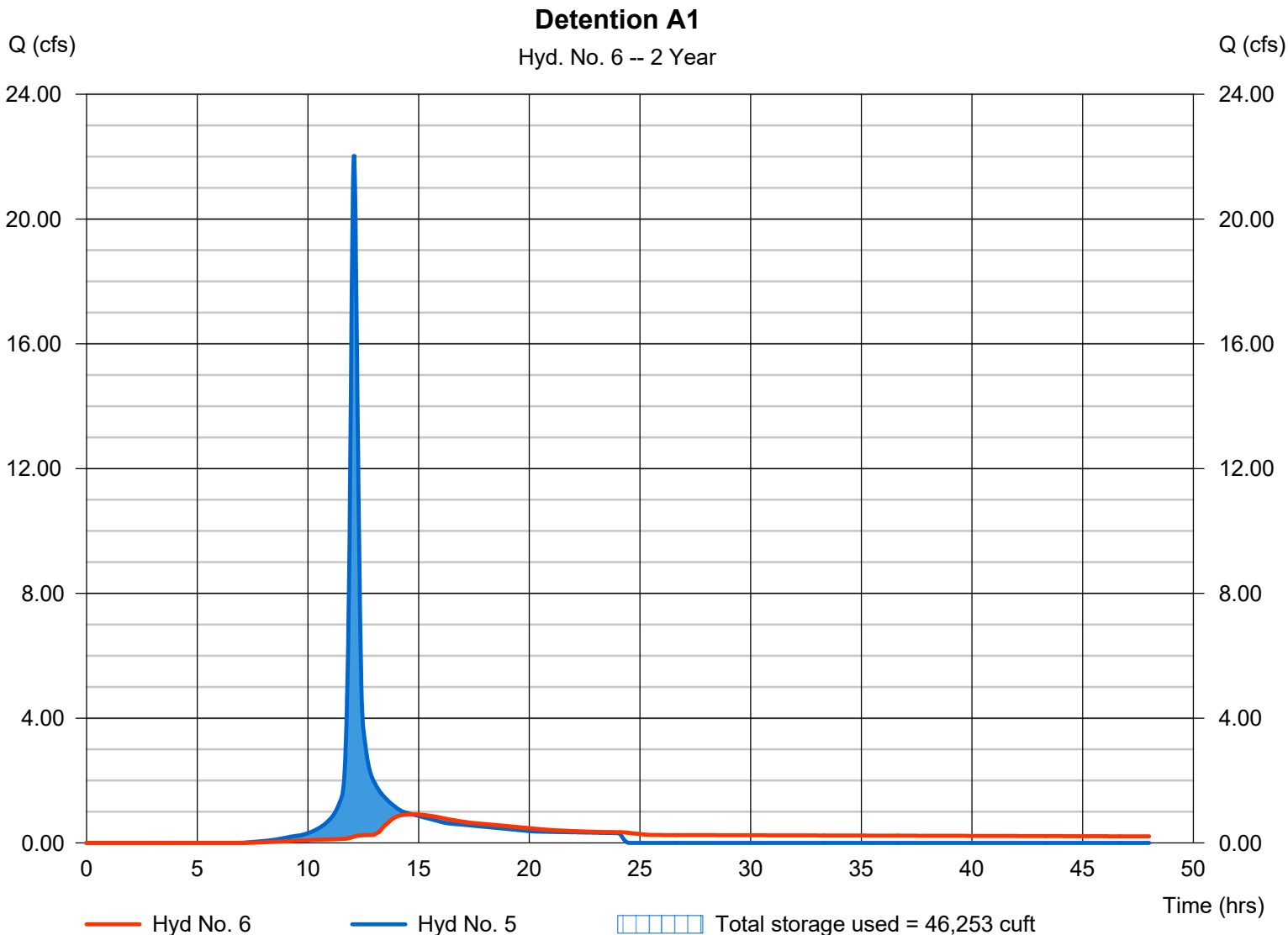

Pond No. 1 - DETENTION

Pond Data

Contours -User-defined contour areas. Average end area method used for volume calculation. Beginning Elevation = 1003.20 ft

Stage / Storage Table

Stage (ft)	Elevation (ft)	Contour area (sqft)	Incr. Storage (cuft)	Total storage (cuft)
0.00	1003.20	00	0	0
0.81	1004.00	3,348	1,356	1,356
1.81	1005.00	8,924	6,136	7,492
2.81	1006.00	10,668	9,796	17,288
3.81	1007.00	11,892	11,280	28,568
4.81	1008.00	13,173	12,533	41,101
5.81	1009.00	15,167	14,170	55,271
6.81	1010.00	17,649	16,408	71,679
7.81	1011.00	20,457	19,053	90,732
8.81	1012.00	23,070	21,764	112,495
9.81	1013.00	25,693	24,382	136,877
10.30	1013.50	35,624	15,022	151,899

Culvert / Orifice Structures

	[A]	[B]	[C]	[PrfRsr]
Rise (in)	= 24.00	2.00	12.00	0.00
Span (in)	= 24.00	2.00	12.00	0.00
No. Barrels	= 1	1	2	0
Invert El. (ft)	= 1003.10	1003.10	1008.10	0.00
Length (ft)	= 39.00	1.00	1.00	0.00
Slope (%)	= 3.23	1.00	1.00	n/a
N-Value	= .013	.013	.013	n/a
Orifice Coeff.	= 0.66	0.66	0.66	0.60
Multi-Stage	= n/a	Yes	Yes	No

Weir Structures

	[A]	[B]	[C]	[D]
Crest Len (ft)	= 9.50	80.00	0.00	0.00
Crest El. (ft)	= 1012.60	1012.05	0.00	0.00
Weir Coeff.	= 3.33	2.60	3.33	3.33
Weir Type	= Rect	Broad	---	---
Multi-Stage	= Yes	No	No	No
Exfil.(in/hr)	= 0.000 (by Contour)			
TW Elev. (ft)	= 0.00			

Note: Culvert/Orifice outflows are analyzed under inlet (ic) and outlet (oc) control. Weir risers checked for orifice conditions (ic) and submergence (s).

Stage / Storage / Discharge Table

Stage ft	Storage cuft	Elevation ft	Civ A cfs	Civ B cfs	Civ C cfs	PrfRsr cfs	Wr A cfs	Wr B cfs	Wr C cfs	Wr D cfs	Exfil cfs	User cfs	Total cfs
0.00	0	1003.20	0.00	0.00	0.00	---	0.00	0.00	---	---	---	---	0.000
0.81	1,356	1004.00	0.10 ic	0.10 ic	0.00	---	0.00	0.00	---	---	---	---	0.102
1.81	7,492	1005.00	0.16 ic	0.15 ic	0.00	---	0.00	0.00	---	---	---	---	0.153
2.81	17,288	1006.00	0.20 ic	0.19 ic	0.00	---	0.00	0.00	---	---	---	---	0.191
3.81	28,568	1007.00	0.22 ic	0.22 ic	0.00	---	0.00	0.00	---	---	---	---	0.223
4.81	41,101	1008.00	0.27 ic	0.25 ic	0.00	---	0.00	0.00	---	---	---	---	0.251
5.81	55,271	1009.00	5.67 ic	0.26 ic	5.31 ic	---	0.00	0.00	---	---	---	---	5.566
6.81	71,679	1010.00	10.15 ic	0.27 ic	9.84 ic	---	0.00	0.00	---	---	---	---	10.11
7.81	90,732	1011.00	13.18 ic	0.29 ic	12.89 ic	---	0.00	0.00	---	---	---	---	13.18
8.81	112,495	1012.00	15.67 ic	0.31 ic	15.34 ic	---	0.00	0.00	---	---	---	---	15.65
9.81	136,877	1013.00	25.75 ic	0.29 ic	17.45 ic	---	8.00	192.60	---	---	---	---	218.35
10.30	151,899	1013.50	41.82 ic	0.20 ic	14.60 ic	---	27.01	363.18	---	---	---	---	405.00

Hydrograph Report

Hydraflow Hydrographs Extension for AutoCAD® Civil 3D® 2018 by Autodesk, Inc. v12

Thursday, 07 / 26 / 2018

Hyd. No. 7

POI A

Hydrograph type	= Combine	Peak discharge	= 23.91 cfs
Storm frequency	= 2 yrs	Time to peak	= 12.08 hrs
Time interval	= 1 min	Hyd. volume	= 119,416 cuft
Inflow hyds.	= 4, 6	Contrib. drain. area	= 10.120 ac

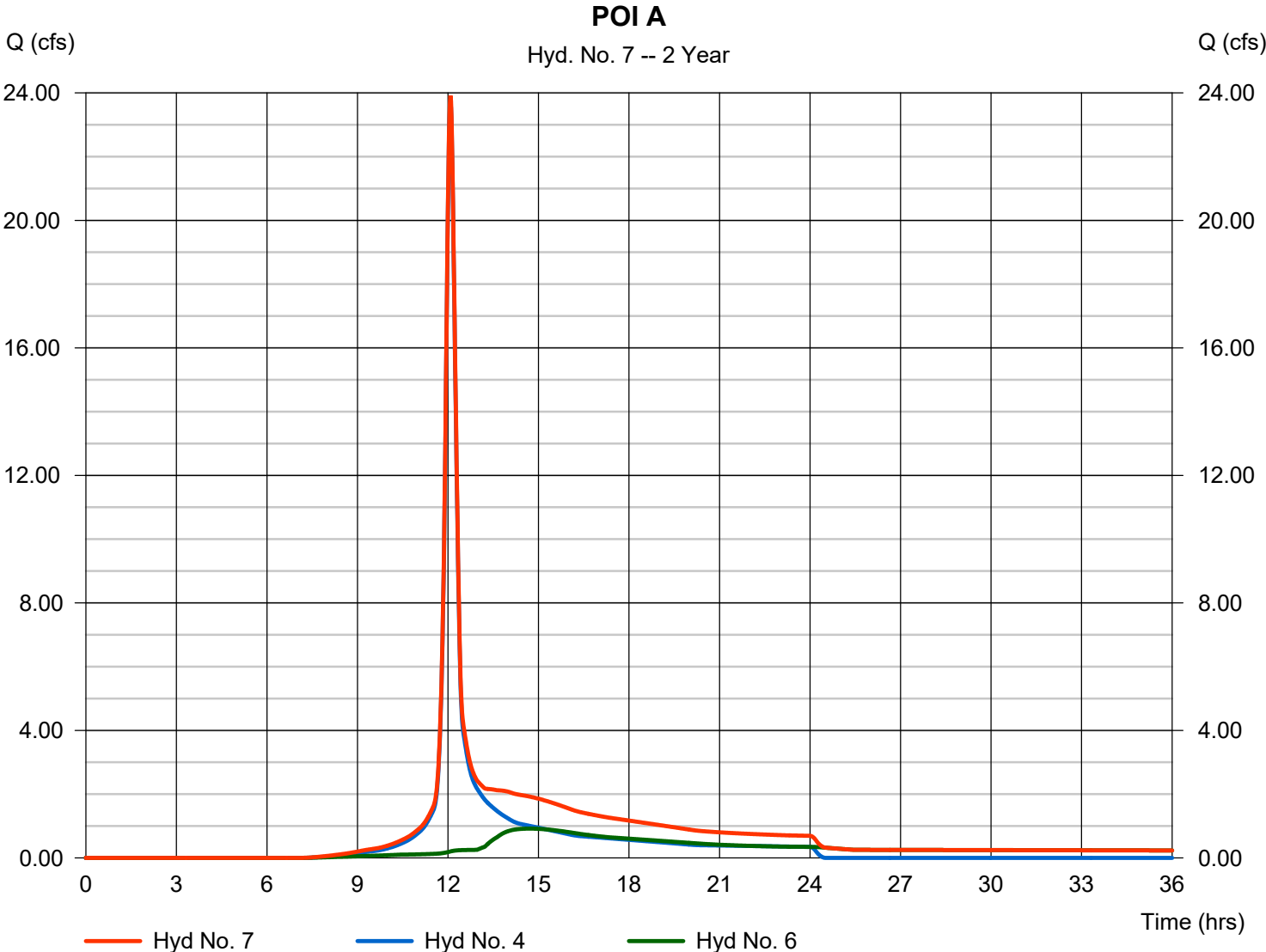

Hydrograph Summary Report

Hydraflow Hydrographs Extension for AutoCAD® Civil 3D® 2018 by Autodesk, Inc. v12

Hyd. No.	Hydrograph type (origin)	Peak flow (cfs)	Time interval (min)	Time to Peak (min)	Hyd. volume (cuft)	Inflow hyd(s)	Maximum elevation (ft)	Total strge used (cuft)	Hydrograph Description
1	SCS Runoff	61.65	1	726	202,499	-----	-----	-----	Existing Sub-basin A
2	SCS Runoff	63.62	1	726	208,983	-----	-----	-----	Proposed Sub-basin A
3	SCS Runoff	78.23	1	725	247,268	-----	-----	-----	Future Sub-basin A
4	SCS Runoff	41.30	1	725	130,535	-----	-----	-----	Future Sub-basin A
5	SCS Runoff	37.87	1	725	120,174	-----	-----	-----	Future Sub-basin A1
6	Reservoir	8.011	1	745	96,037	5	1009.47	62,953	Detention A1
7	Combine	41.55	1	725	226,572	4, 6	-----	-----	POI A
7-24-18 HAMBLÉN STUDY.gpw					Return Period: 10 Year			Thursday, 07 / 26 / 2018	

Hydrograph Report

Hydraflow Hydrographs Extension for AutoCAD® Civil 3D® 2018 by Autodesk, Inc. v12

Thursday, 07 / 26 / 2018

Hyd. No. 1

Existing Sub-basin A

Hydrograph type = SCS Runoff
 Storm frequency = 10 yrs
 Time interval = 1 min
 Drainage area = 19.170 ac
 Basin Slope = 0.0 %
 Tc method = User
 Total precip. = 5.20 in
 Storm duration = 24 hrs

Peak discharge = 61.65 cfs
 Time to peak = 12.10 hrs
 Hyd. volume = 202,499 cuft
 Curve number = 78
 Hydraulic length = 0 ft
 Time of conc. (Tc) = 20.90 min
 Distribution = Type II
 Shape factor = 484

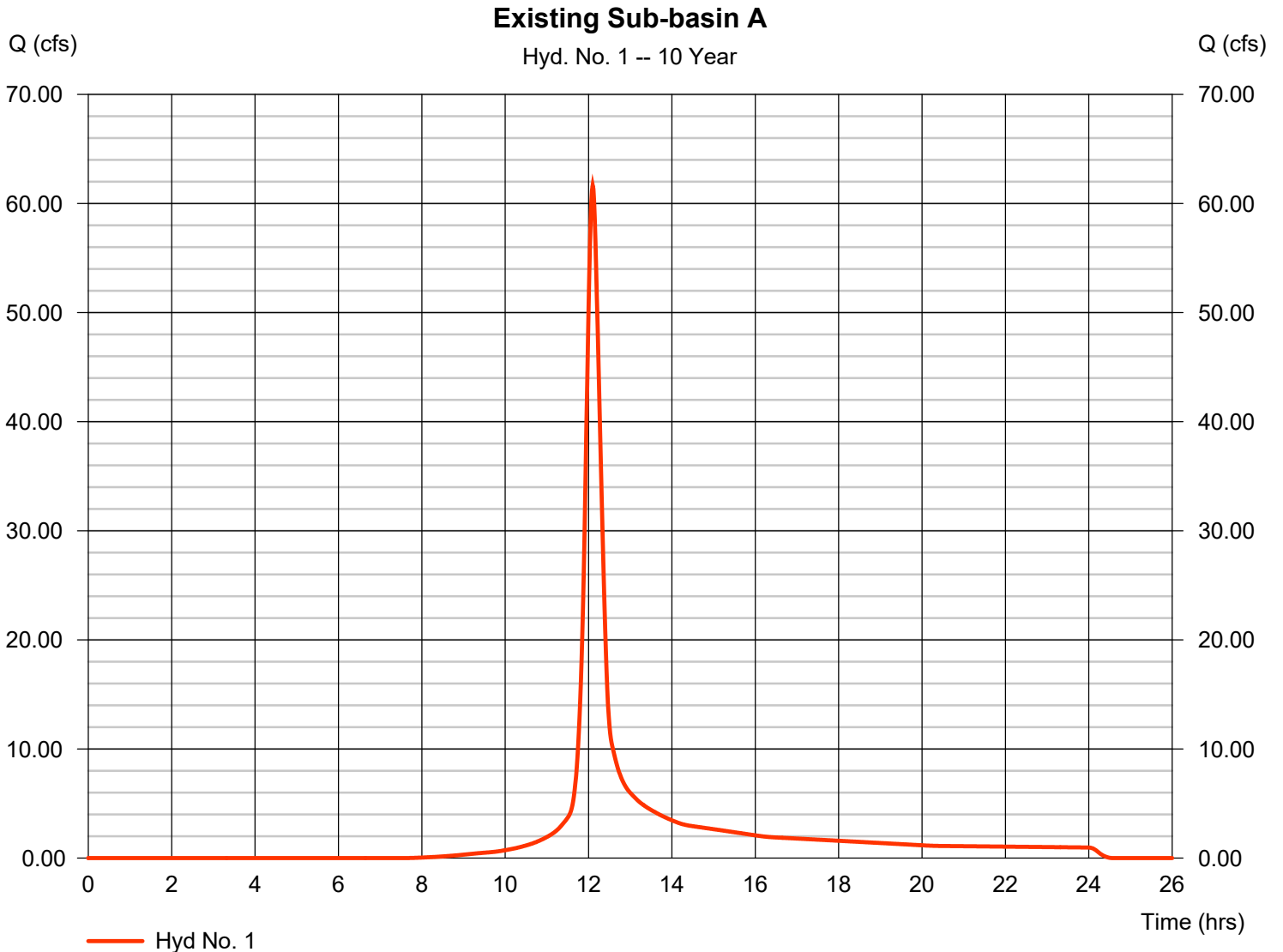

Hydrograph Report

Hydraflow Hydrographs Extension for AutoCAD® Civil 3D® 2018 by Autodesk, Inc. v12

Thursday, 07 / 26 / 2018

Hyd. No. 2

Proposed Sub-basin A

Hydrograph type	= SCS Runoff	Peak discharge	= 63.62 cfs
Storm frequency	= 10 yrs	Time to peak	= 12.10 hrs
Time interval	= 1 min	Hyd. volume	= 208,983 cuft
Drainage area	= 19.170 ac	Curve number	= 79
Basin Slope	= 0.0 %	Hydraulic length	= 0 ft
Tc method	= User	Time of conc. (Tc)	= 20.90 min
Total precip.	= 5.20 in	Distribution	= Type II
Storm duration	= 24 hrs	Shape factor	= 484

Proposed Sub-basin A

Hyd. No. 2 -- 10 Year

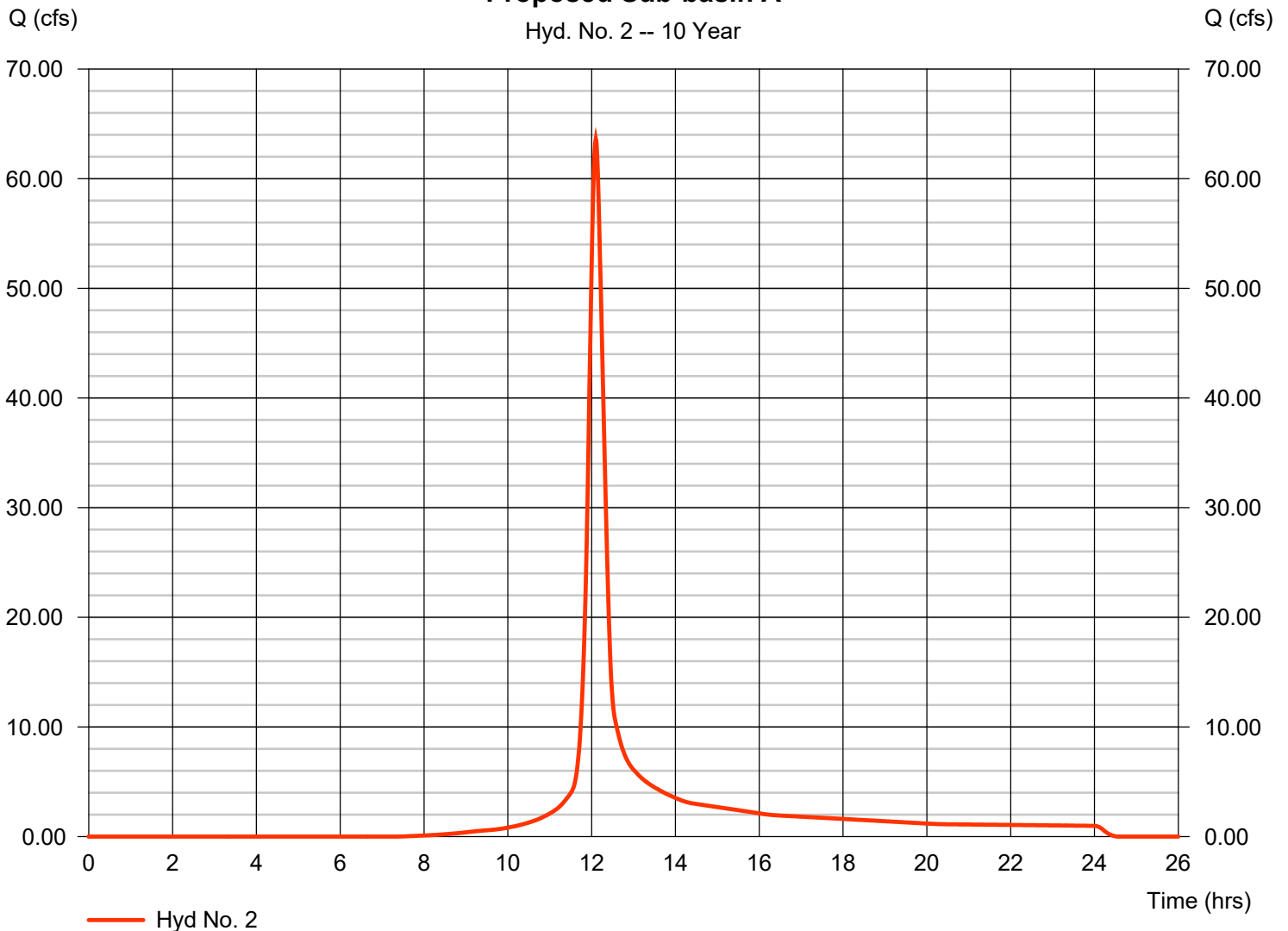

Hydrograph Report

Hydraflow Hydrographs Extension for AutoCAD® Civil 3D® 2018 by Autodesk, Inc. v12

Thursday, 07 / 26 / 2018

Hyd. No. 3

Future Sub-basin A

Hydrograph type	= SCS Runoff	Peak discharge	= 78.23 cfs
Storm frequency	= 10 yrs	Time to peak	= 12.08 hrs
Time interval	= 1 min	Hyd. volume	= 247,268 cuft
Drainage area	= 19.170 ac	Curve number	= 85
Basin Slope	= 0.0 %	Hydraulic length	= 0 ft
Tc method	= User	Time of conc. (Tc)	= 19.80 min
Total precip.	= 5.20 in	Distribution	= Type II
Storm duration	= 24 hrs	Shape factor	= 484

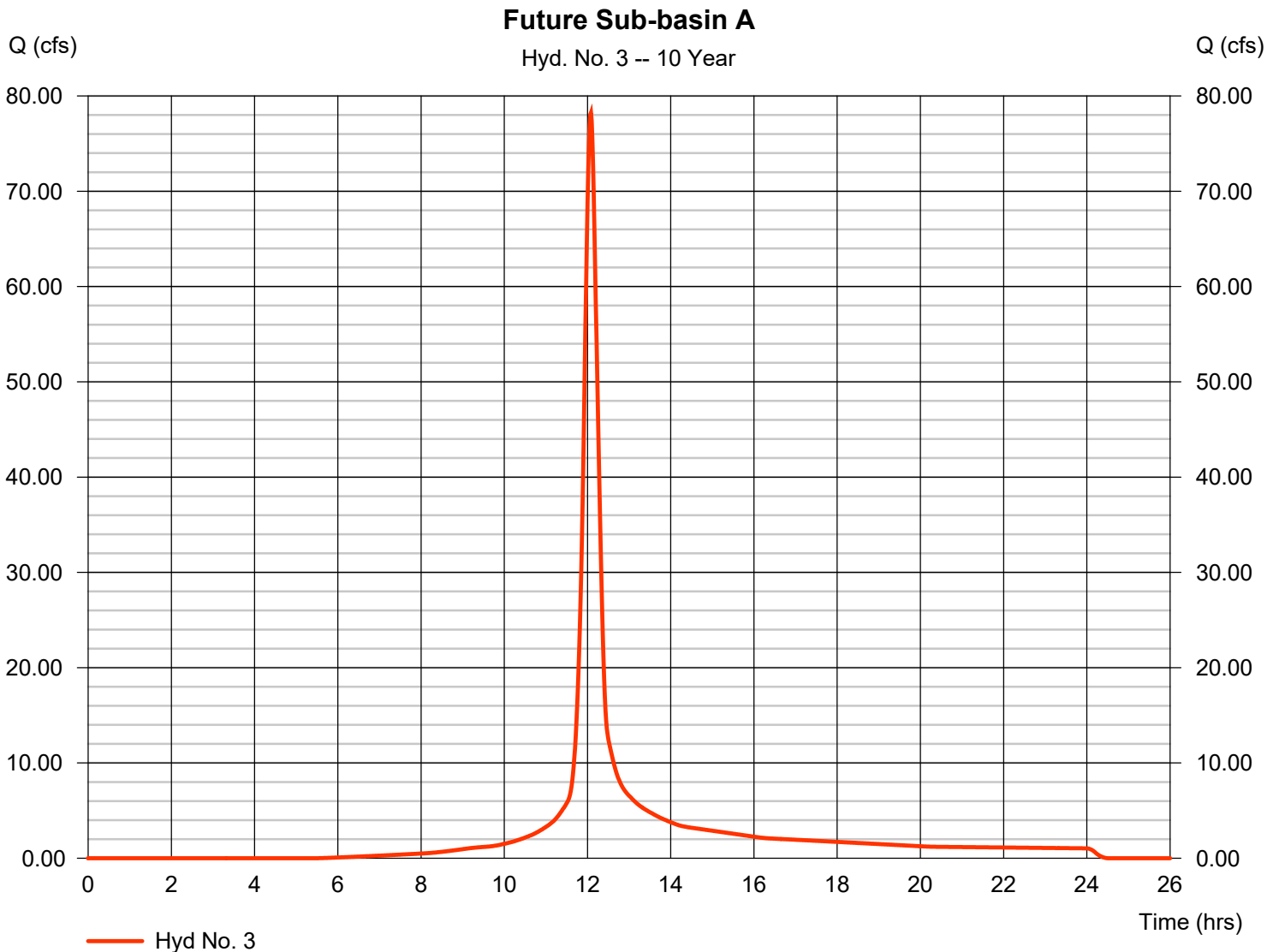

Hydrograph Report

Hydraflow Hydrographs Extension for AutoCAD® Civil 3D® 2018 by Autodesk, Inc. v12

Thursday, 07 / 26 / 2018

Hyd. No. 4

Future Sub-basin A

Hydrograph type	= SCS Runoff	Peak discharge	= 41.30 cfs
Storm frequency	= 10 yrs	Time to peak	= 12.08 hrs
Time interval	= 1 min	Hyd. volume	= 130,535 cuft
Drainage area	= 10.120 ac	Curve number	= 85
Basin Slope	= 0.0 %	Hydraulic length	= 0 ft
Tc method	= User	Time of conc. (Tc)	= 19.80 min
Total precip.	= 5.20 in	Distribution	= Type II
Storm duration	= 24 hrs	Shape factor	= 484

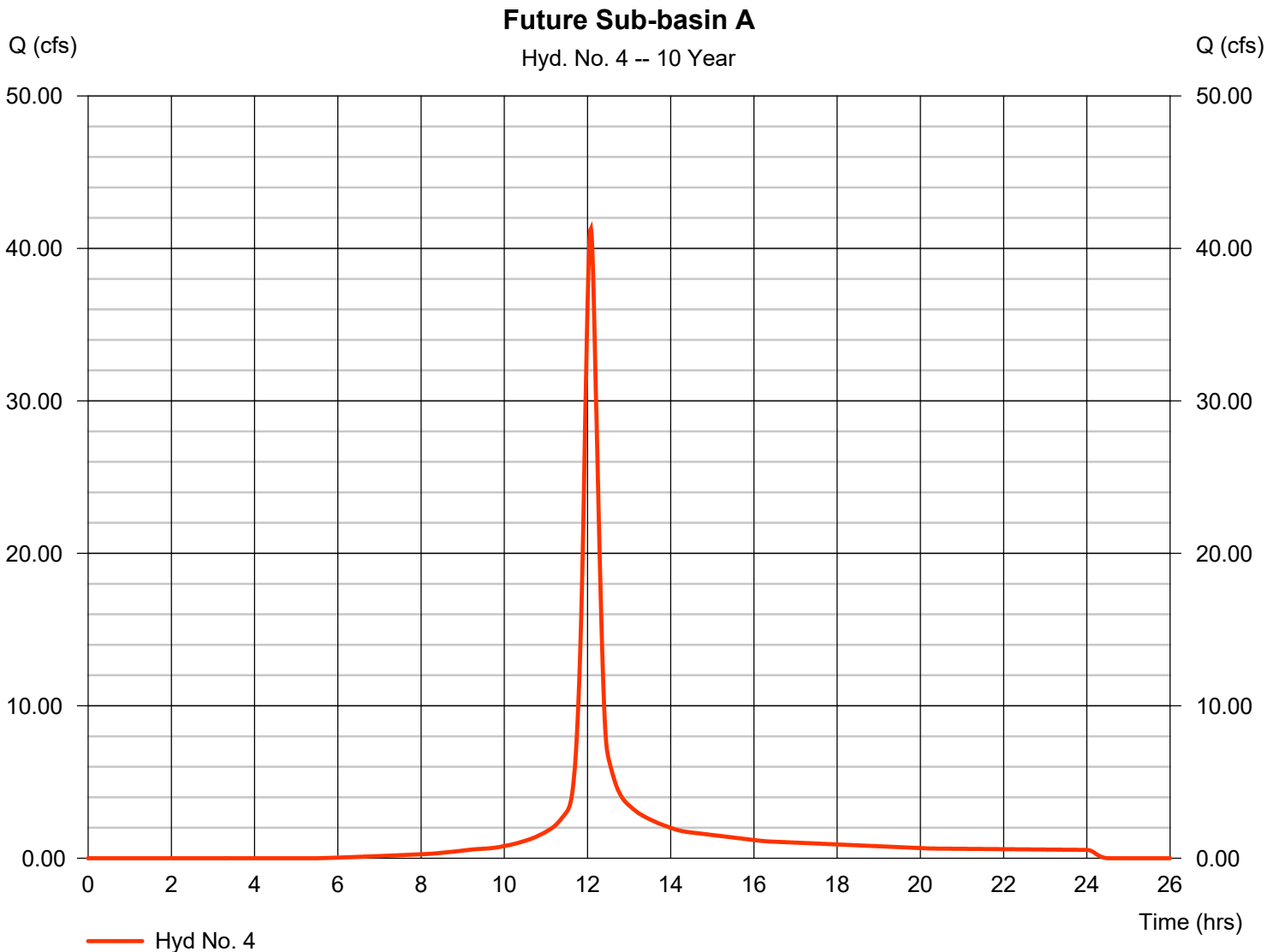

Hydrograph Report

Hydraflow Hydrographs Extension for AutoCAD® Civil 3D® 2018 by Autodesk, Inc. v12

Thursday, 07 / 26 / 2018

Hyd. No. 5

Future Sub-basin A1

Hydrograph type	= SCS Runoff	Peak discharge	= 37.87 cfs
Storm frequency	= 10 yrs	Time to peak	= 12.08 hrs
Time interval	= 1 min	Hyd. volume	= 120,174 cuft
Drainage area	= 9.060 ac	Curve number	= 86
Basin Slope	= 0.0 %	Hydraulic length	= 0 ft
Tc method	= User	Time of conc. (Tc)	= 19.00 min
Total precip.	= 5.20 in	Distribution	= Type II
Storm duration	= 24 hrs	Shape factor	= 484

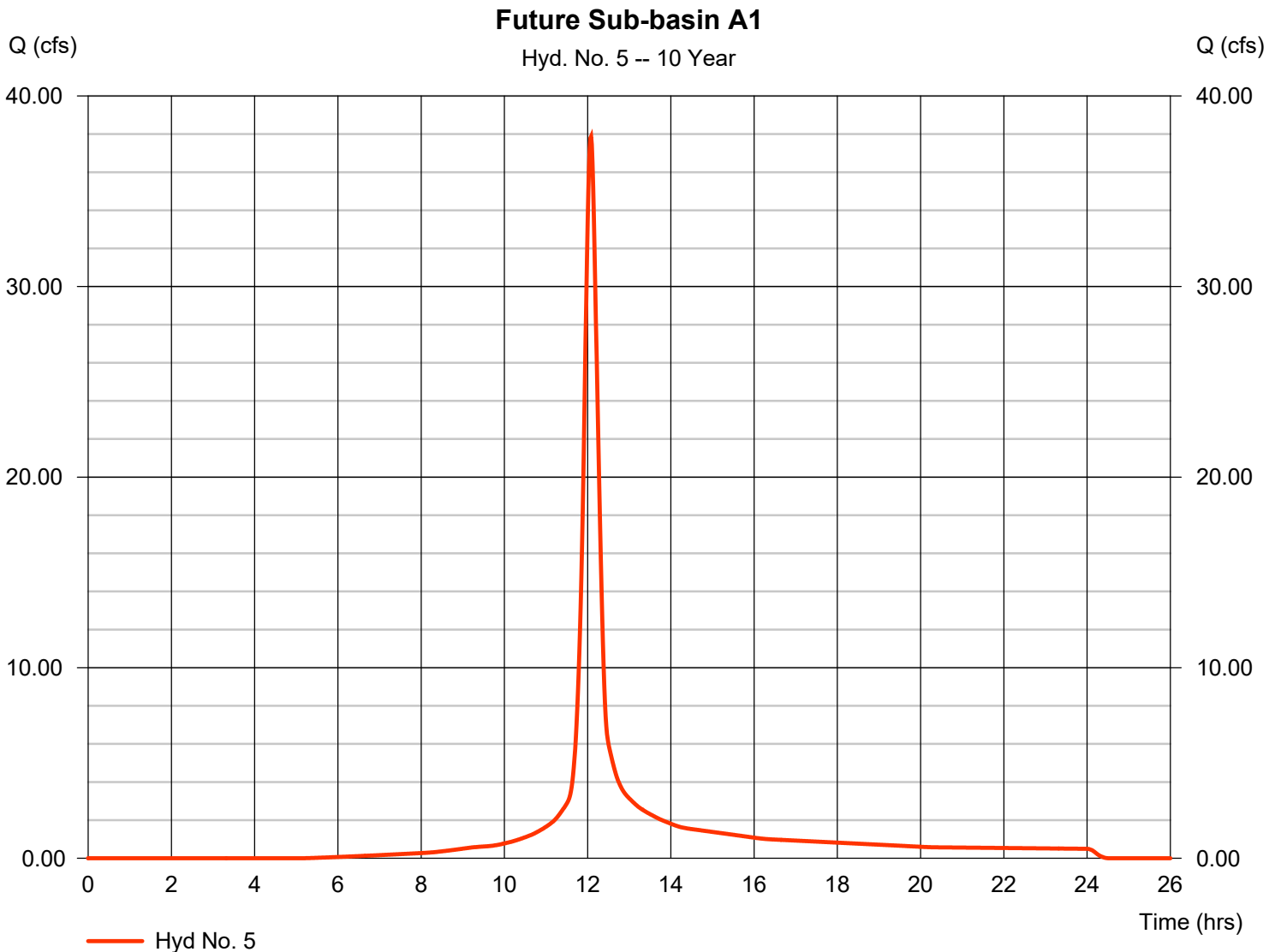

Hydrograph Report

Hydraflow Hydrographs Extension for AutoCAD® Civil 3D® 2018 by Autodesk, Inc. v12

Thursday, 07 / 26 / 2018

Hyd. No. 6

Detention A1

Hydrograph type	= Reservoir	Peak discharge	= 8.011 cfs
Storm frequency	= 10 yrs	Time to peak	= 12.42 hrs
Time interval	= 1 min	Hyd. volume	= 96,037 cuft
Inflow hyd. No.	= 5 - Future Sub-basin A1	Max. Elevation	= 1009.47 ft
Reservoir name	= DETENTION	Max. Storage	= 62,953 cuft

Storage Indication method used.

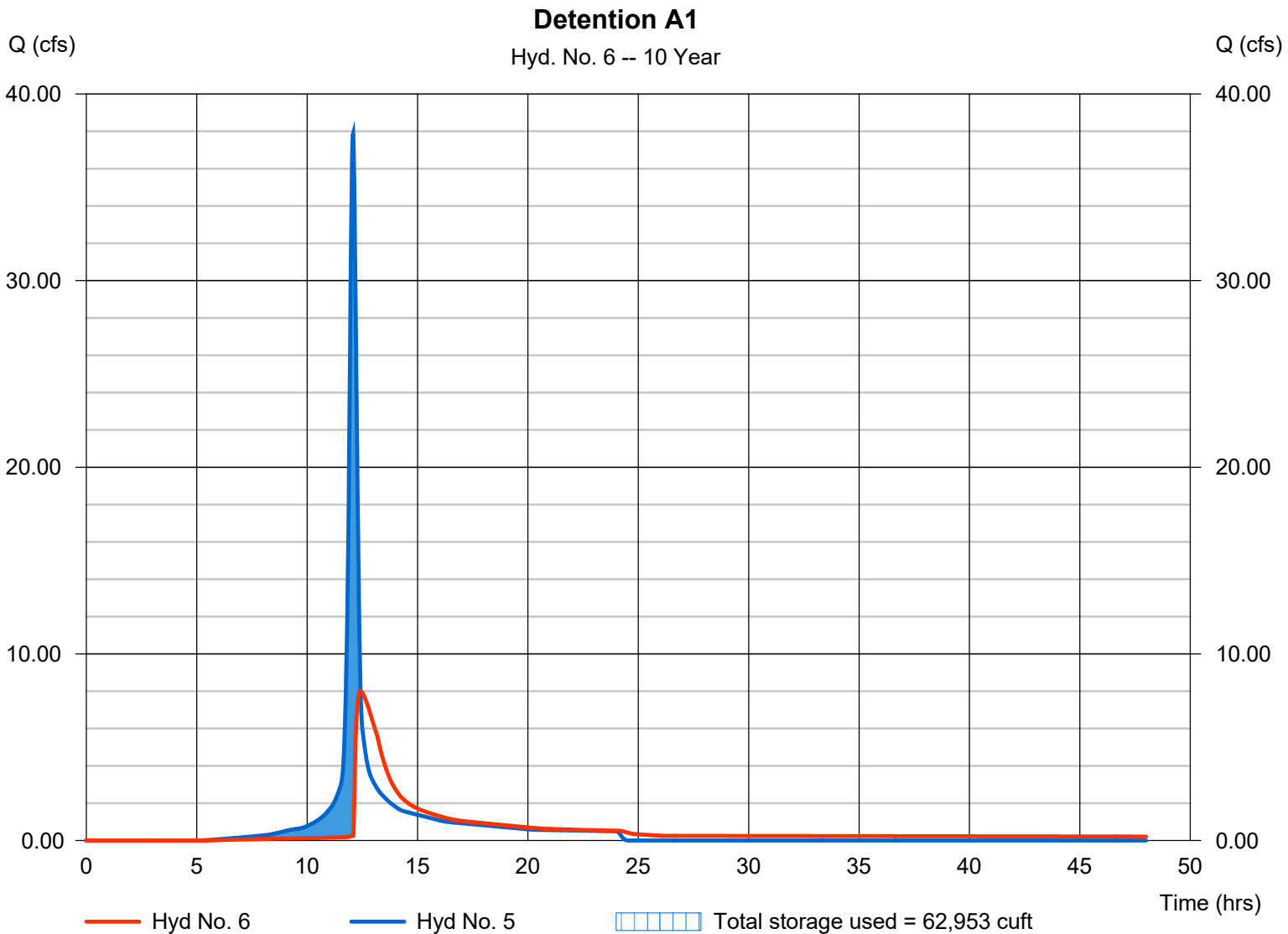

Hydrograph Report

Hydraflow Hydrographs Extension for AutoCAD® Civil 3D® 2018 by Autodesk, Inc. v12

Thursday, 07 / 26 / 2018

Hyd. No. 7

POI A

Hydrograph type = Combine
Storm frequency = 10 yrs
Time interval = 1 min
Inflow hyds. = 4, 6

Peak discharge = 41.55 cfs
Time to peak = 12.08 hrs
Hyd. volume = 226,572 cuft
Contrib. drain. area = 10.120 ac

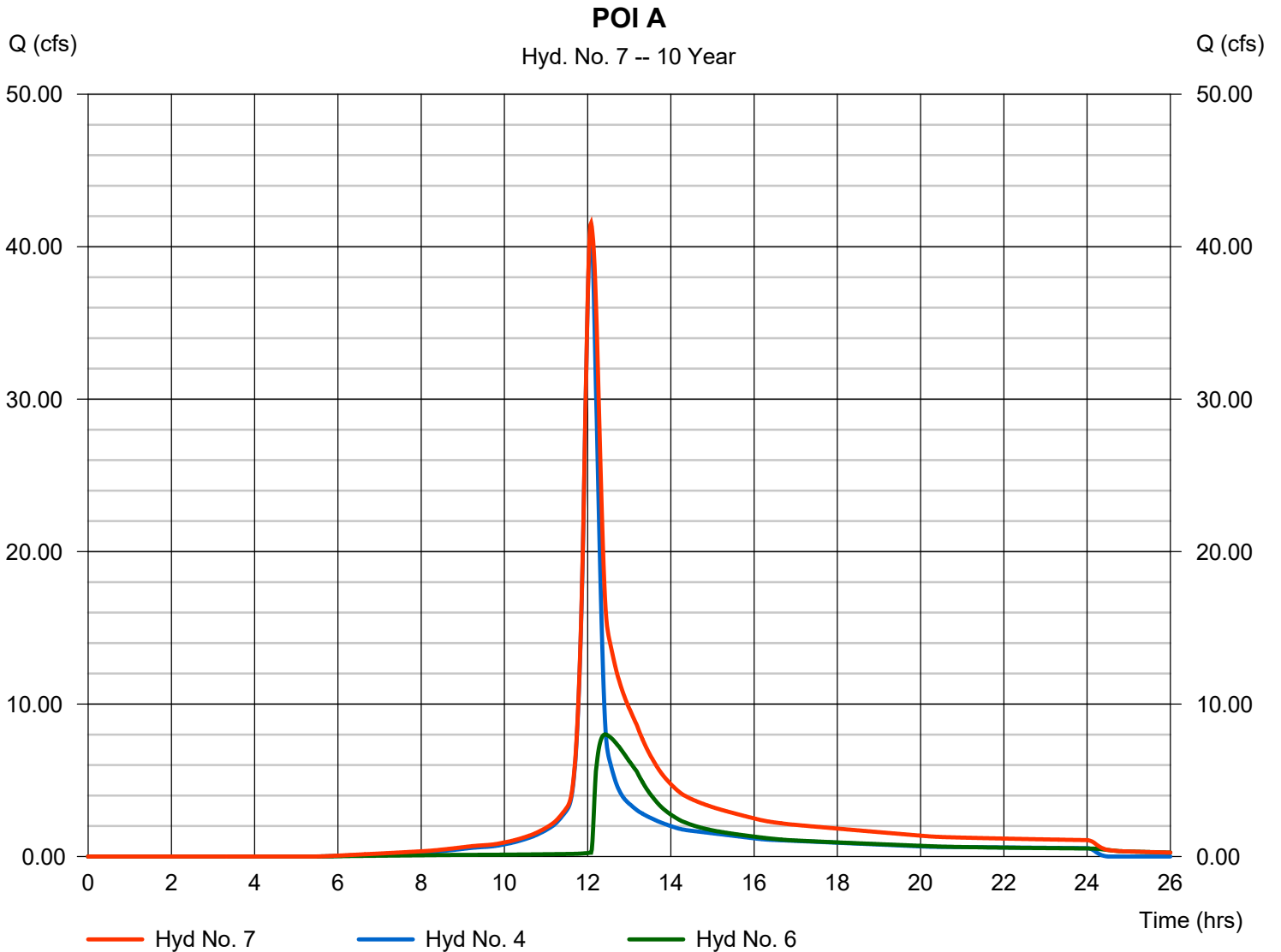

Hydrograph Summary Report

Hydraflow Hydrographs Extension for AutoCAD® Civil 3D® 2018 by Autodesk, Inc. v12

Hyd. No.	Hydrograph type (origin)	Peak flow (cfs)	Time interval (min)	Time to Peak (min)	Hyd. volume (cuft)	Inflow hyd(s)	Maximum elevation (ft)	Total strge used (cuft)	Hydrograph Description	
1	SCS Runoff	108.59	1	726	359,318	-----	-----	-----	Existing Sub-basin A	
2	SCS Runoff	110.78	1	726	367,385	-----	-----	-----	Proposed Sub-basin A	
3	SCS Runoff	127.64	1	725	412,243	-----	-----	-----	Future Sub-basin A	
4	SCS Runoff	67.38	1	725	217,626	-----	-----	-----	Future Sub-basin A	
5	SCS Runoff	61.21	1	724	198,672	-----	-----	-----	Future Sub-basin A1	
6	Reservoir	14.44	1	744	174,182	5	1011.49	101,365	Detention A1	
7	Combine	77.80	1	725	391,808	4, 6	-----	-----	POI A	
7-24-18 HAMBLÉN STUDY.gpw					Return Period: 100 Year			Thursday, 07 / 26 / 2018		

Hydrograph Report

Hydraflow Hydrographs Extension for AutoCAD® Civil 3D® 2018 by Autodesk, Inc. v12

Thursday, 07 / 26 / 2018

Hyd. No. 1

Existing Sub-basin A

Hydrograph type	= SCS Runoff	Peak discharge	= 108.59 cfs
Storm frequency	= 100 yrs	Time to peak	= 12.10 hrs
Time interval	= 1 min	Hyd. volume	= 359,318 cuft
Drainage area	= 19.170 ac	Curve number	= 78
Basin Slope	= 0.0 %	Hydraulic length	= 0 ft
Tc method	= User	Time of conc. (Tc)	= 20.90 min
Total precip.	= 7.70 in	Distribution	= Type II
Storm duration	= 24 hrs	Shape factor	= 484

Existing Sub-basin A

Hyd. No. 1 -- 100 Year

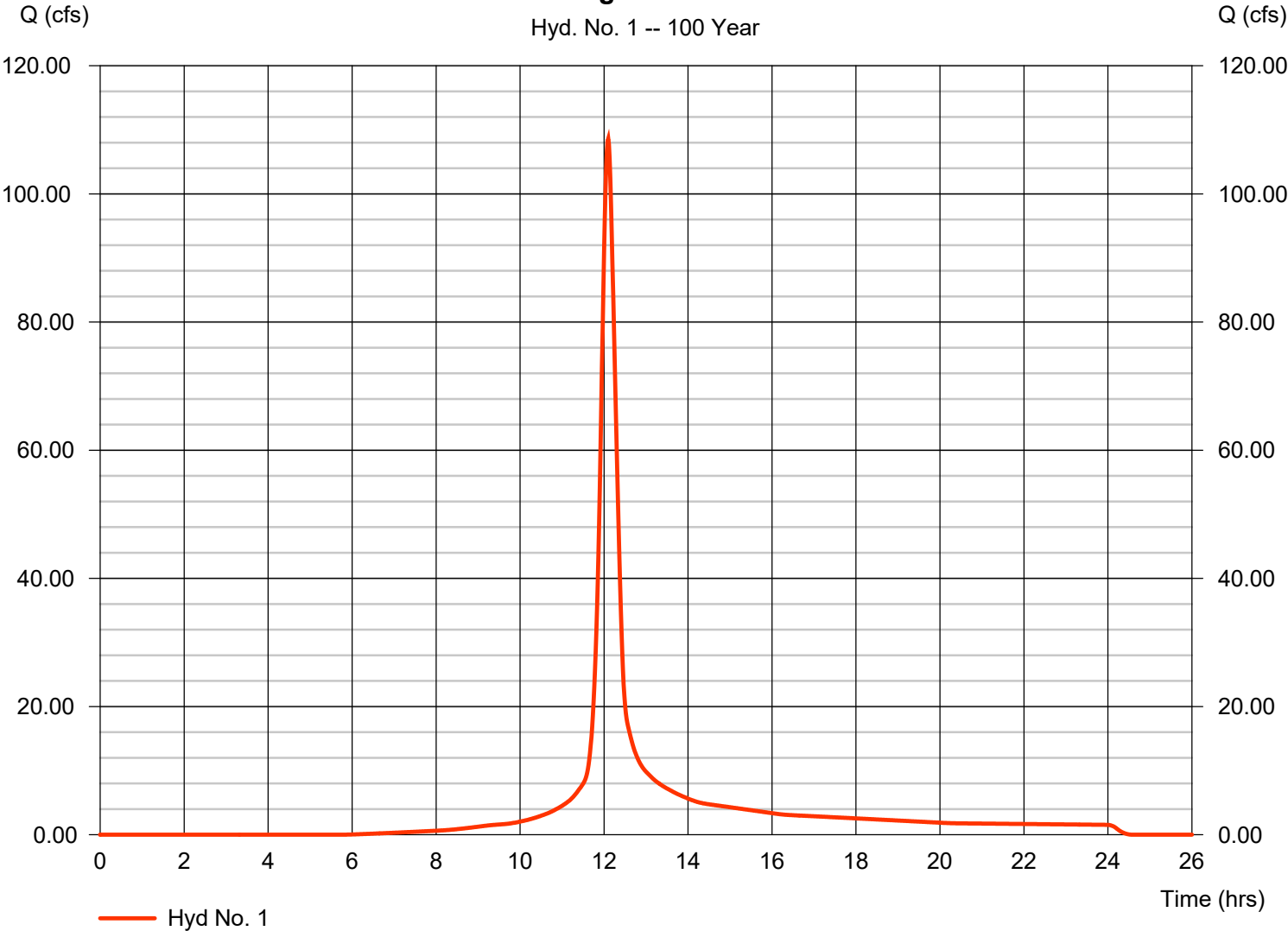

Hydrograph Report

Hydraflow Hydrographs Extension for AutoCAD® Civil 3D® 2018 by Autodesk, Inc. v12

Thursday, 07 / 26 / 2018

Hyd. No. 2

Proposed Sub-basin A

Hydrograph type	= SCS Runoff	Peak discharge	= 110.78 cfs
Storm frequency	= 100 yrs	Time to peak	= 12.10 hrs
Time interval	= 1 min	Hyd. volume	= 367,385 cuft
Drainage area	= 19.170 ac	Curve number	= 79
Basin Slope	= 0.0 %	Hydraulic length	= 0 ft
Tc method	= User	Time of conc. (Tc)	= 20.90 min
Total precip.	= 7.70 in	Distribution	= Type II
Storm duration	= 24 hrs	Shape factor	= 484

Proposed Sub-basin A

Hyd. No. 2 -- 100 Year

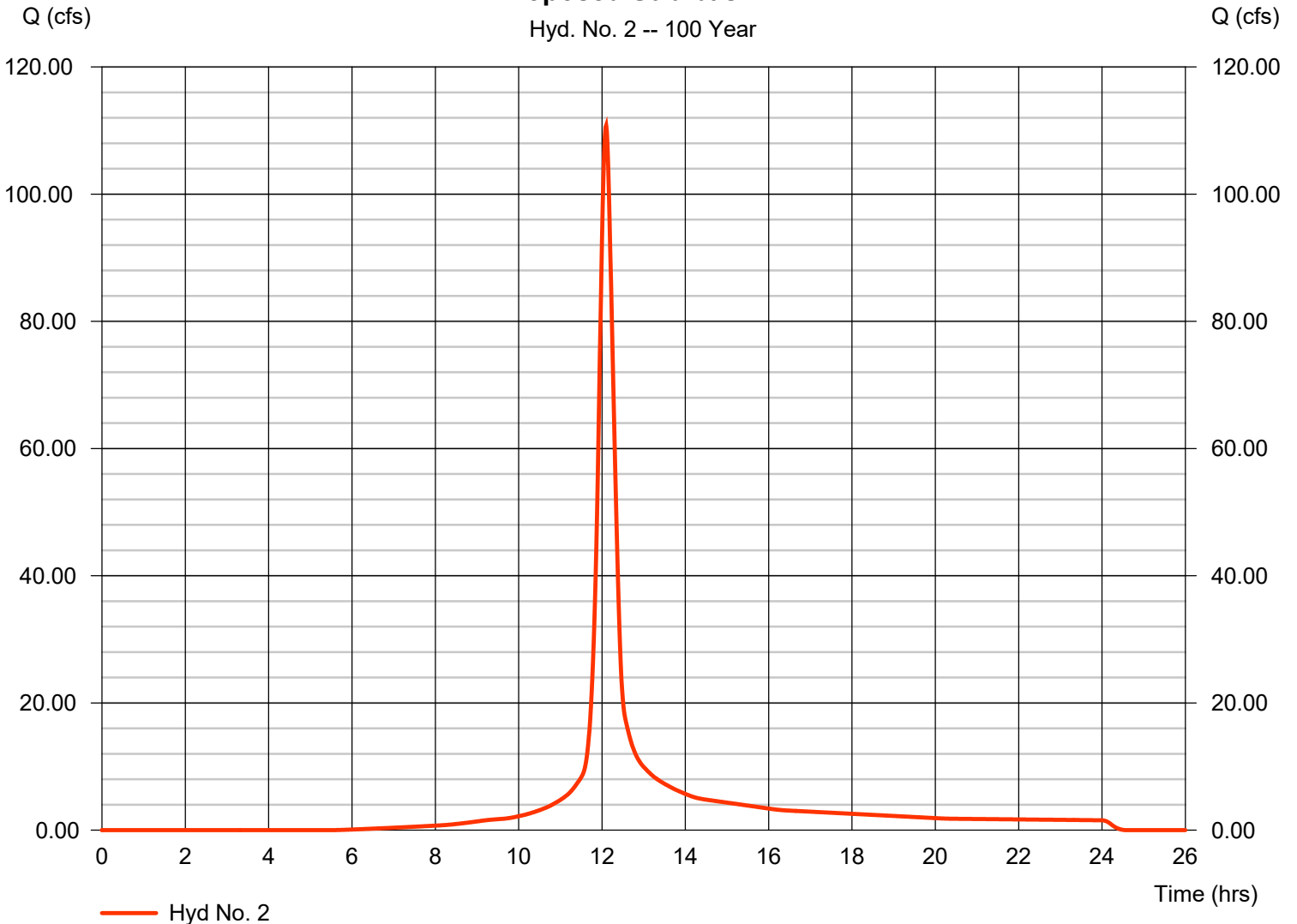

Hydrograph Report

Hydraflow Hydrographs Extension for AutoCAD® Civil 3D® 2018 by Autodesk, Inc. v12

Thursday, 07 / 26 / 2018

Hyd. No. 3

Future Sub-basin A

Hydrograph type = SCS Runoff
 Storm frequency = 100 yrs
 Time interval = 1 min
 Drainage area = 19.170 ac
 Basin Slope = 0.0 %
 Tc method = User
 Total precip. = 7.70 in
 Storm duration = 24 hrs

Peak discharge = 127.64 cfs
 Time to peak = 12.08 hrs
 Hyd. volume = 412,243 cuft
 Curve number = 85
 Hydraulic length = 0 ft
 Time of conc. (Tc) = 19.80 min
 Distribution = Type II
 Shape factor = 484

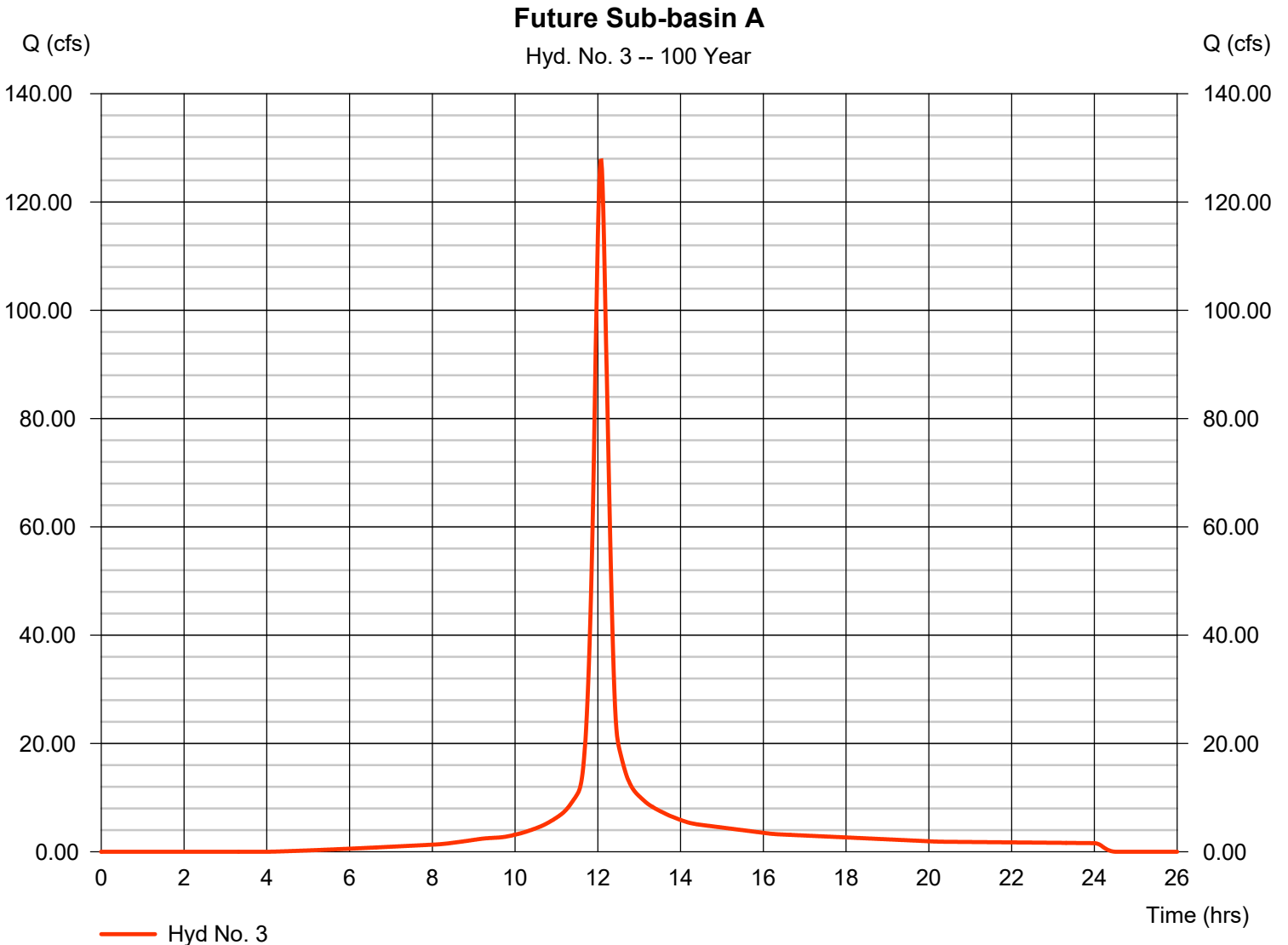

Hydrograph Report

Hydraflow Hydrographs Extension for AutoCAD® Civil 3D® 2018 by Autodesk, Inc. v12

Thursday, 07 / 26 / 2018

Hyd. No. 4

Future Sub-basin A

Hydrograph type = SCS Runoff
 Storm frequency = 100 yrs
 Time interval = 1 min
 Drainage area = 10.120 ac
 Basin Slope = 0.0 %
 Tc method = User
 Total precip. = 7.70 in
 Storm duration = 24 hrs

Peak discharge = 67.38 cfs
 Time to peak = 12.08 hrs
 Hyd. volume = 217,626 cuft
 Curve number = 85
 Hydraulic length = 0 ft
 Time of conc. (Tc) = 19.80 min
 Distribution = Type II
 Shape factor = 484

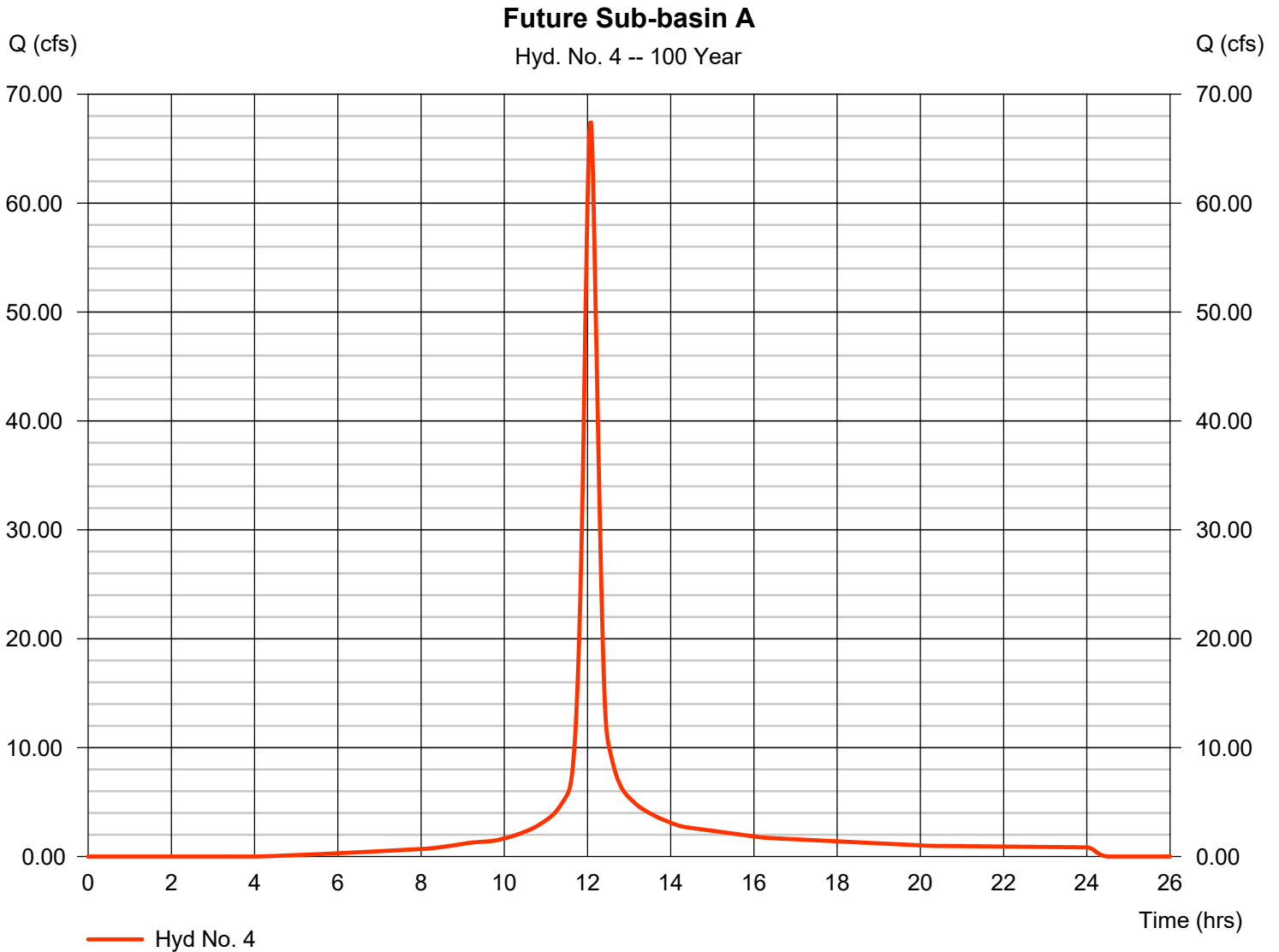

Hydrograph Report

Hydraflow Hydrographs Extension for AutoCAD® Civil 3D® 2018 by Autodesk, Inc. v12

Thursday, 07 / 26 / 2018

Hyd. No. 5

Future Sub-basin A1

Hydrograph type = SCS Runoff
 Storm frequency = 100 yrs
 Time interval = 1 min
 Drainage area = 9.060 ac
 Basin Slope = 0.0 %
 Tc method = User
 Total precip. = 7.70 in
 Storm duration = 24 hrs

Peak discharge = 61.21 cfs
 Time to peak = 12.07 hrs
 Hyd. volume = 198,672 cuft
 Curve number = 86
 Hydraulic length = 0 ft
 Time of conc. (Tc) = 19.00 min
 Distribution = Type II
 Shape factor = 484

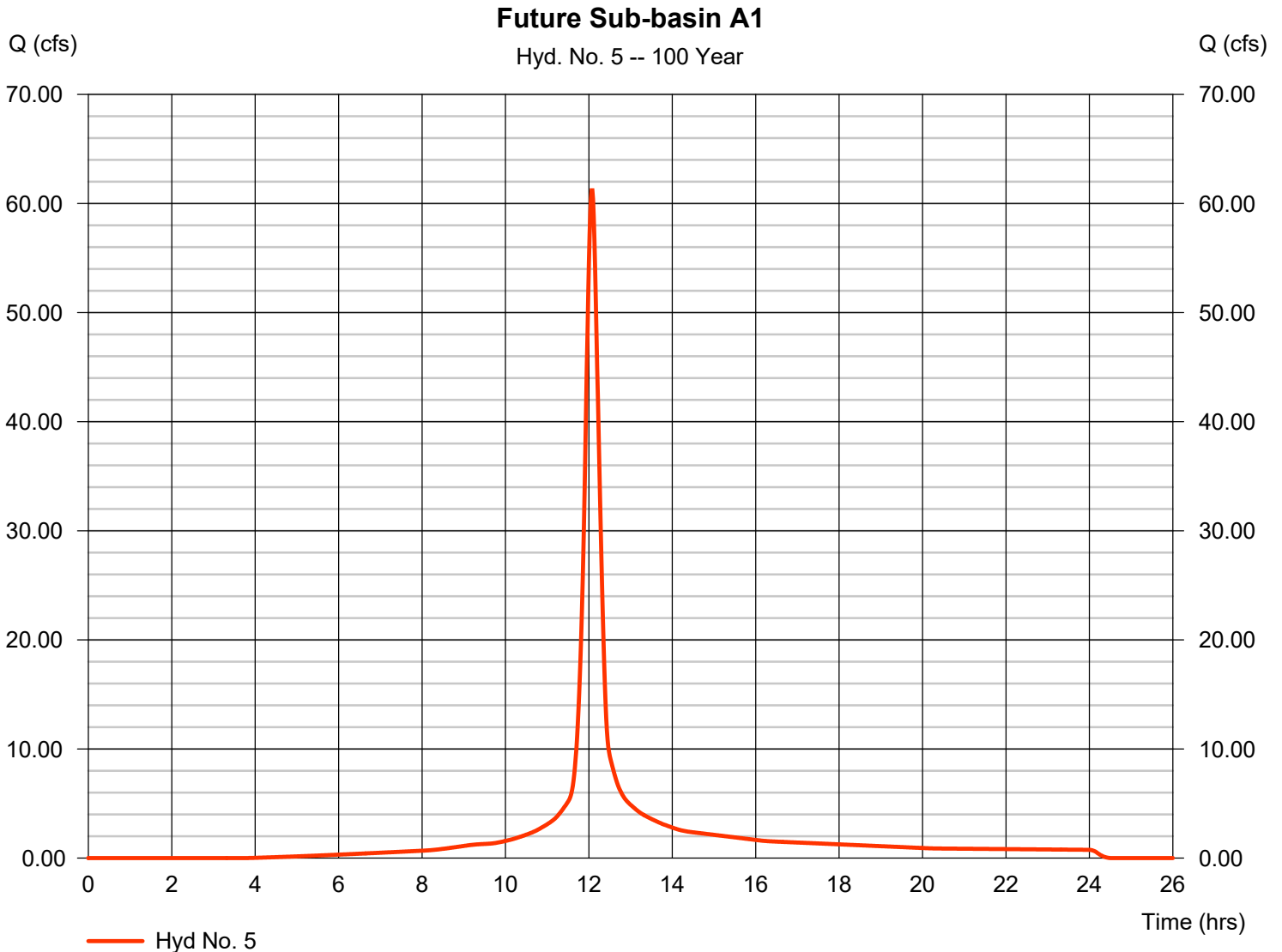

Hydrograph Report

Hydraflow Hydrographs Extension for AutoCAD® Civil 3D® 2018 by Autodesk, Inc. v12

Thursday, 07 / 26 / 2018

Hyd. No. 6

Detention A1

Hydrograph type	= Reservoir	Peak discharge	= 14.44 cfs
Storm frequency	= 100 yrs	Time to peak	= 12.40 hrs
Time interval	= 1 min	Hyd. volume	= 174,182 cuft
Inflow hyd. No.	= 5 - Future Sub-basin A1	Max. Elevation	= 1011.49 ft
Reservoir name	= DETENTION	Max. Storage	= 101,365 cuft

Storage Indication method used.

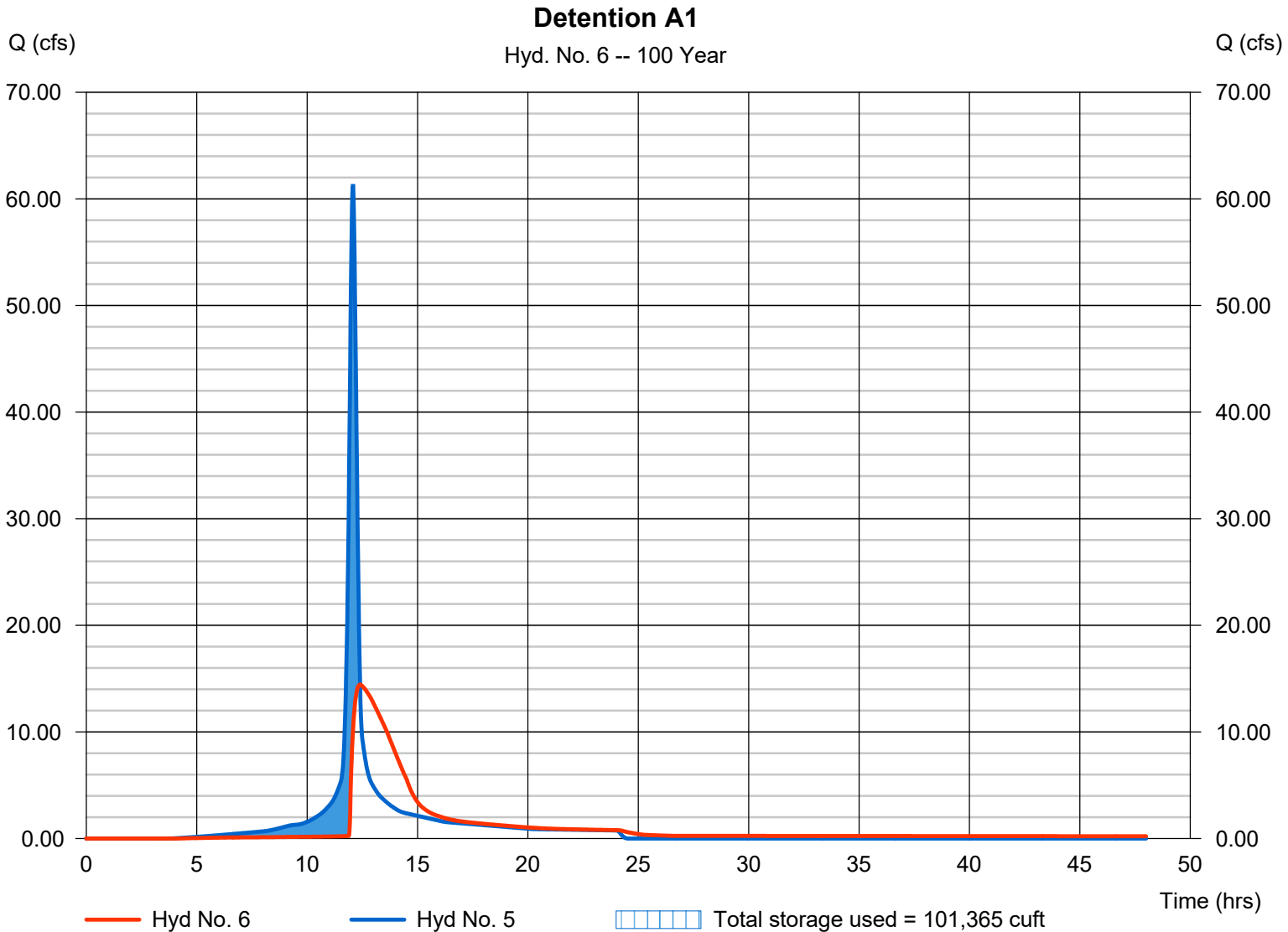

Hydrograph Report

Hydraflow Hydrographs Extension for AutoCAD® Civil 3D® 2018 by Autodesk, Inc. v12

Thursday, 07 / 26 / 2018

Hyd. No. 7

POI A

Hydrograph type = Combine
Storm frequency = 100 yrs
Time interval = 1 min
Inflow hyds. = 4, 6

Peak discharge = 77.80 cfs
Time to peak = 12.08 hrs
Hyd. volume = 391,808 cuft
Contrib. drain. area = 10.120 ac

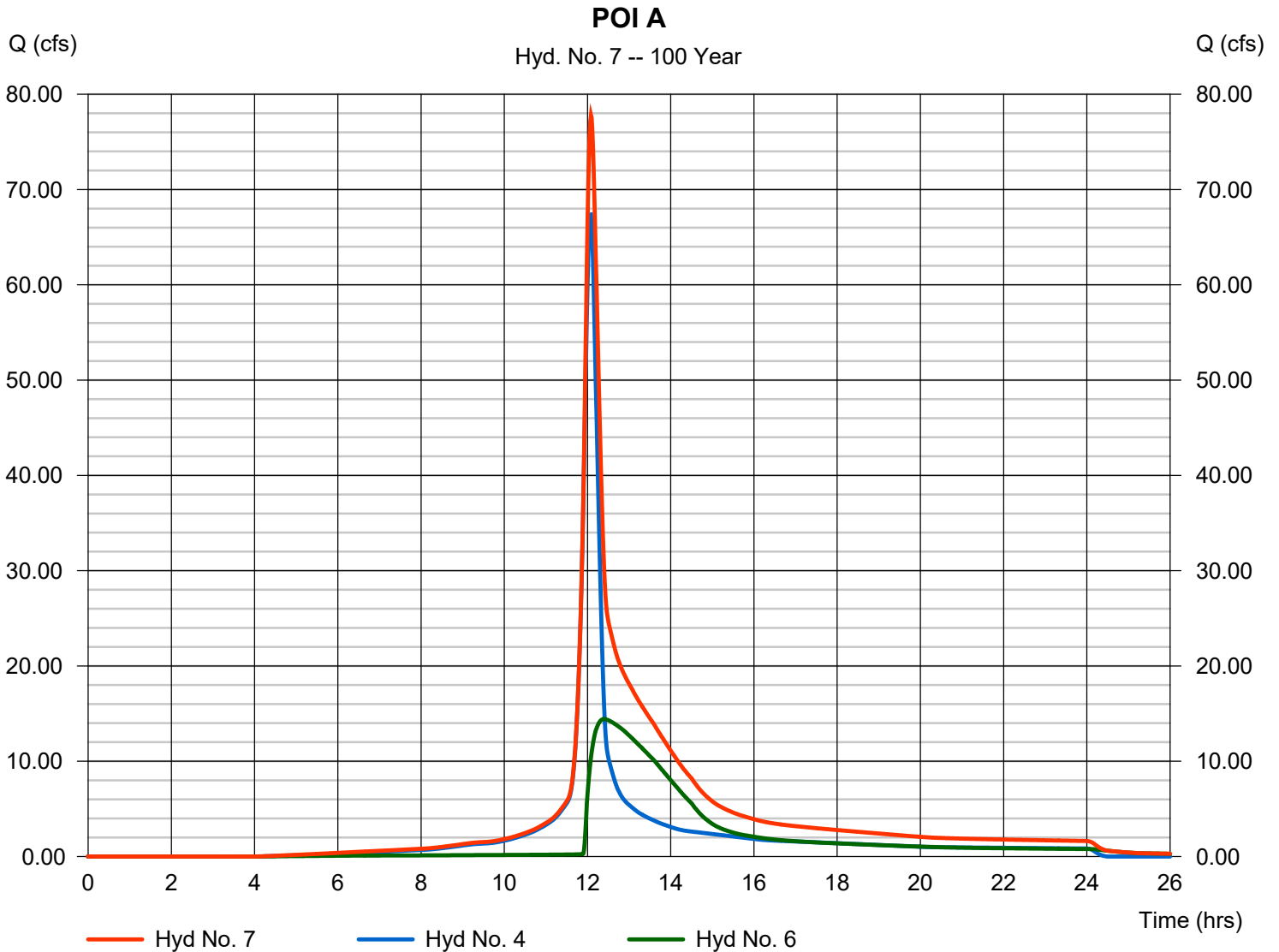

Hydraflow Rainfall Report

Hydraflow Hydrographs Extension for AutoCAD® Civil 3D® 2018 by Autodesk, Inc. v12

Thursday, 07 / 26 / 2018

Return Period (Yrs)	Intensity-Duration-Frequency Equation Coefficients (FHA)			
	B	D	E	(N/A)
1	64.1474	17.7000	0.8922	-----
2	95.7859	19.2000	0.9317	-----
3	0.0000	0.0000	0.0000	-----
5	118.7799	19.1000	0.9266	-----
10	125.1300	18.2000	0.9051	-----
25	158.9867	18.7000	0.9180	-----
50	171.2459	18.3000	0.9078	-----
100	187.3624	18.1000	0.9031	-----

File name: KCMO.IDF

$$\text{Intensity} = B / (T_c + D)^E$$

Return Period (Yrs)	Intensity Values (in/hr)											
	5 min	10	15	20	25	30	35	40	45	50	55	60
1	3.96	3.31	2.86	2.52	2.25	2.04	1.87	1.72	1.60	1.49	1.40	1.32
2	4.92	4.13	3.56	3.14	2.81	2.54	2.32	2.14	1.98	1.85	1.73	1.63
3	0.00	0.00	0.00	0.00	0.00	0.00	0.00	0.00	0.00	0.00	0.00	0.00
5	6.23	5.23	4.51	3.98	3.56	3.22	2.94	2.71	2.52	2.35	2.20	2.07
10	7.27	6.09	5.26	4.63	4.14	3.75	3.43	3.16	2.93	2.74	2.57	2.42
25	8.70	7.30	6.30	5.54	4.96	4.49	4.10	3.78	3.51	3.27	3.07	2.89
50	9.83	8.24	7.11	6.26	5.60	5.07	4.64	4.27	3.97	3.70	3.47	3.27
100	11.00	9.21	7.95	7.00	6.26	5.67	5.19	4.78	4.44	4.14	3.89	3.66

T_c = time in minutes. Values may exceed 60.

Precip. file name: Z:\acad\KCMO.pcp

Storm Distribution	Rainfall Precipitation Table (in)							
	1-yr	2-yr	3-yr	5-yr	10-yr	25-yr	50-yr	100-yr
SCS 24-hour	1.37	3.50	0.00	3.30	5.20	6.00	6.80	7.70
SCS 6-Hr	0.00	1.80	0.00	0.00	2.60	0.00	0.00	4.00
Huff-1st	0.00	1.55	0.00	2.75	4.00	5.38	6.50	8.00
Huff-2nd	2.49	3.10	0.00	4.01	4.64	5.52	6.21	6.90
Huff-3rd	0.00	0.00	0.00	0.00	0.00	0.00	0.00	0.00
Huff-4th	0.00	0.00	0.00	0.00	0.00	0.00	0.00	0.00
Huff-Indy	0.00	1.55	0.00	2.75	4.00	5.38	6.50	8.00
Custom	0.00	1.75	0.00	2.80	3.90	5.25	6.00	7.10

Weir Report

EMERGENCY SPILLWAY - EARTHEN BROAD CRESTED WEIR

Rectangular Weir

Crest = Broad
Bottom Length (ft) = 80.00
Total Depth (ft) = 1.50

Highlighted

Depth (ft) = 0.44
Q (cfs) = 61.21
Area (sqft) = 35.38
Velocity (ft/s) = 1.73
Top Width (ft) = 80.00

Calculations

Weir Coeff. C_w = 2.60
Compute by: Known Q
Known Q (cfs) = 61.21

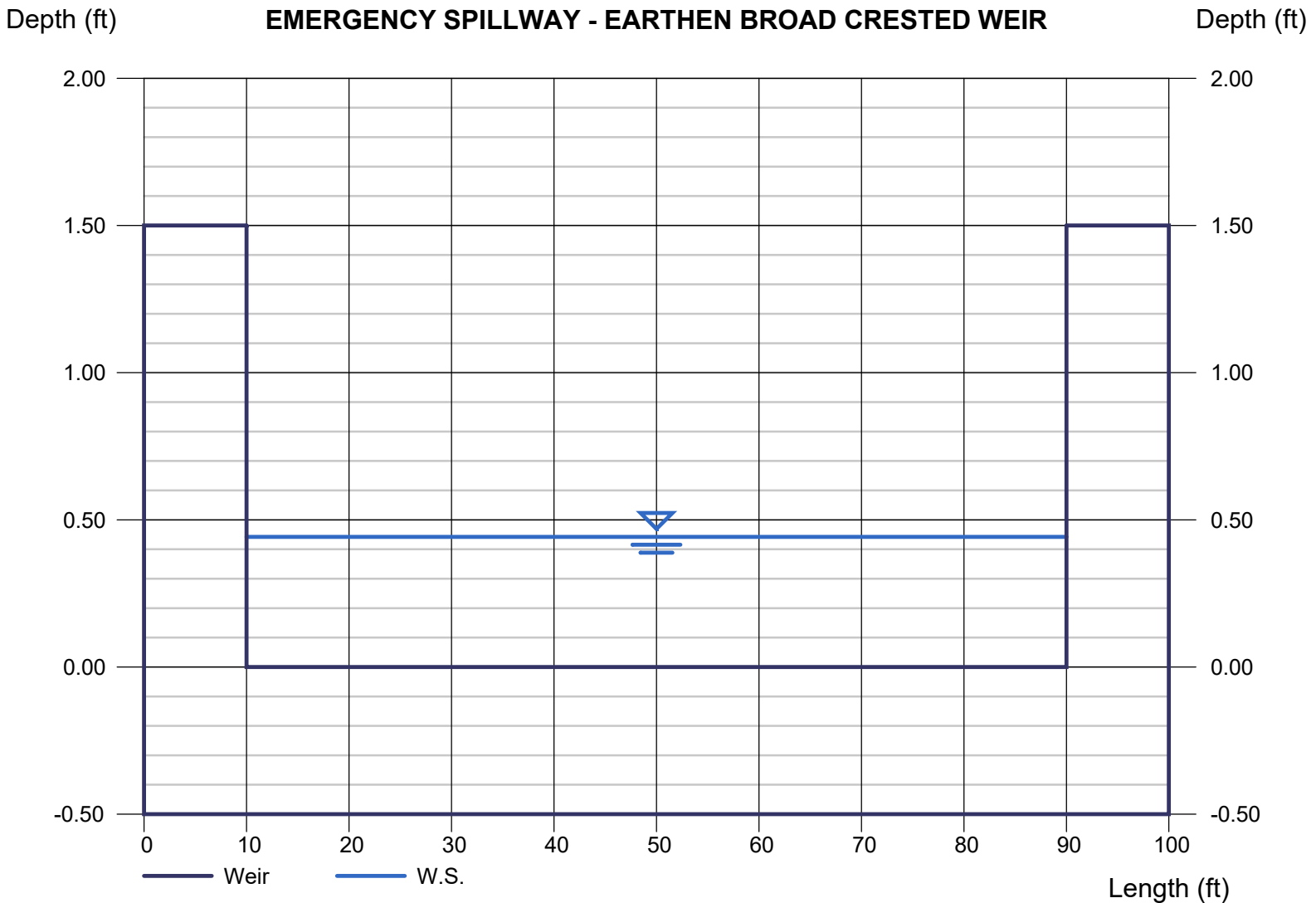

Friction Slope Method (Inlet Pipe Analysis)

Q (cfs)	14.04	100 Year Peak Discharge (from Model)
n	0.011	
D (ft)	2	
A (sf)	3.140	
R (ft)	0.5	
Sf (ft)	0.0028	
L (ft)	20	
Hf (ft)	0.06	Friction Headloss
Minor Losses		
Kentrance	0.5	Per APWA Table 5603-2: Head Loss Coefficients
V (fps)	4.47	
Hm (ft)	0.16	Minor Headloss
Headloss (ft)	0.21	
Available Head (ft)	0.51	Available Head = Spillway Crest Elevation - 100 Year WSE
Spillway Crest	1012	
100 Year WSE	1011.49	
	GOOD	Headloss <= Available Head