



BUILDING SQUARE FOOTAGE: 260' x 24' = 6240sf  
 5% ALLOWANCE: 312sf

REVERS CHANNEL LETTERS SQUARE FOOTAGE: 3'-10" x 37'-7.6" = 145sf  
 SQUARE FOOTAGE ALLOWANCE: 145sf<312sf



**SIGN TYPE**

CHANNEL LETTER SIGN

**MATERIALS**

- A** ALUMINUM REVERS CHANNEL LETTERS  
 3" RETURNS  
 SPACED 1.5" OFF BACKER  
 -PAINTED ORANGE  
 INTERNAL RGB LED ILLUMINATION  
 .125 ALUMINUM BACKER  
 PAINTED RM WHITE  
 7"X7" RACEWAY MOUNTED TO WALL

**COLOR SPECIFICATION**

- READY MIX WHITE  
 -AKZO NOBEL SATIN FINISH
- MATCH BURNT ORANGE 124 PAINT  
 -AKZO NOBEL SATIN FINISH

**MOUNTING DETAIL**

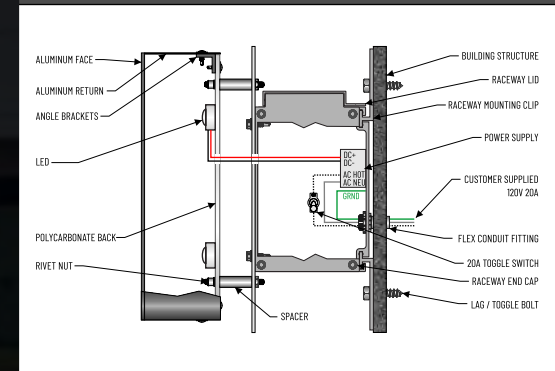







CUSTOMER INFORMATION	SALESPERSON DARRIN GOODSON	ARTIST: EVAN STRATTON / BL	JOB# Q511463	FILE NAME CHANNEL LETTERS	VERSION# 03	PAGE 1	DATE 09.02.2021
----------------------	----------------------------	----------------------------	--------------	---------------------------	-------------	--------	-----------------

CROWN POINTE CHURCH LEE'S SUMMIT, MO	CUSTOMER DESIGN APPROVAL  SIGNATURE:  DATE:	COPYRIGHT NOTICE  <small>THIS DRAWING WAS CREATED COURTESY OF IMPACT SIGNS AWNINGS WRAPS, INC. AS PART OF A PROPOSED SIGN PROJECT. CLIENT MAY NOT DISPLAY, DUPLICATE, OR DISTRIBUTE THIS DRAWING TO ANYONE OUTSIDE OF THE CLIENTS ORGANIZATION WITHOUT WRITTEN CONSENT FROM IMPACT SIGNS AWNINGS WRAPS, INC. UNAUTHORIZED USE MAY CONSTITUTE A COPYRIGHT INFRINGEMENT RESULTING IN DAMAGES AND LEGAL FEES. SEE U.S. COPYRIGHT</small>	DISCLAIMER  <small>THIS DRAWING IS A COMPUTER GENERATED RENDERING AND REPRESENTATION OF THE PROPOSED SIGNAGE. ACTUAL SIGNAGE MAY VARY DUE TO STANDARD MATERIALS AND MANUFACTURING AND/OR INSTALLATION METHODS. COLORS ON SCREEN/PRINTOUT MAY VARY TO FINAL PRODUCT DUE TO COLOR</small>					
---	---	---	---	--	--	--	--	--





CUSTOMER INFORMATION		SALESPERSON	DARRIN GOODSON	ARTIST:	EVAN STRATTON / BL	JOB#	Q511463	FILE NAME	CHANNEL LETTERS	VERSION#	03	PAGE	2	DATE	09.02.2021
CROWN POINTE CHURCH LEE'S SUMMIT, MO		CUSTOMER DESIGN APPROVAL		COPYRIGHT NOTICE		DISCLAIMER		   							
		SIGNATURE:		THIS DRAWING WAS CREATED COURTESY OF IMPACT SIGNS AWNINGS WRAPS, INC. AS PART OF A PROPOSED SIGN PROJECT. CLIENT MAY NOT DISPLAY, DUPLICATE, OR DISTRIBUTE THIS DRAWING TO ANYONE OUTSIDE OF THE CLIENT'S ORGANIZATION WITHOUT WRITTEN CONSENT FROM IMPACT SIGNS AWNINGS WRAPS, INC. UNAUTHORIZED USE MAY CONSTITUTE A COPYRIGHT INFRINGEMENT RESULTING IN DAMAGES AND LEGAL FEES. SEE U.S. COPYRIGHT		THIS DRAWING IS A COMPUTER GENERATED RENDERING AND REPRESENTATION OF THE PROPOSED SIGNAGE. ACTUAL SIGNAGE MAY VARY DUE TO STANDARD MATERIALS AND MANUFACTURING AND/OR INSTALLATION METHODS. COLORS ON SCREEN/PRINTOUT MAY VARY TO FINAL PRODUCT DUE TO COLOR		 <a href="http://impact4800.com">impact4800.com</a>							
		DATE:													